

# Physics Pre-course

Prof. Vivek Muthurangu

Professor of Cardiovascular Imaging & MR Physics - UCL



**EACVI**  
European Association of  
Cardiovascular Imaging

**Nucleus**



**Nucleus**



**odd mass no**

**Nucleus**



**odd mass no**

**$^1\text{H}$ ,  $^{13}\text{C}$ ,  $^{19}\text{F}$ ,  $^{31}\text{P}$**

**Nucleus**



**odd mass no**

**$^1\text{H}$ ,  $^{13}\text{C}$ ,  $^{19}\text{F}$ ,  $^{31}\text{P}$**

**Spin**

**Nucleus**

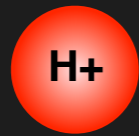

**odd mass no**

**<sup>1</sup>H, <sup>13</sup>C, <sup>19</sup>F, <sup>31</sup>P**

**Spin**

**Nucleus**

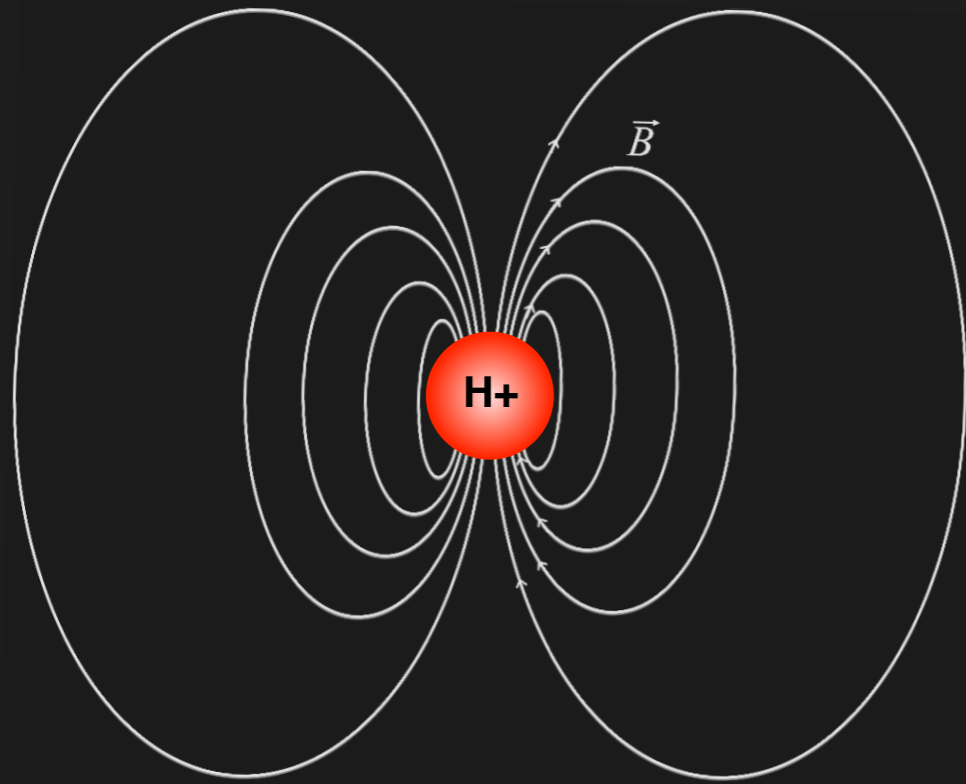

**odd mass no**

**$^1\text{H}$ ,  $^{13}\text{C}$ ,  $^{19}\text{F}$ ,  $^{31}\text{P}$**

**Spin**

**Bar magnet**

## Nucleus

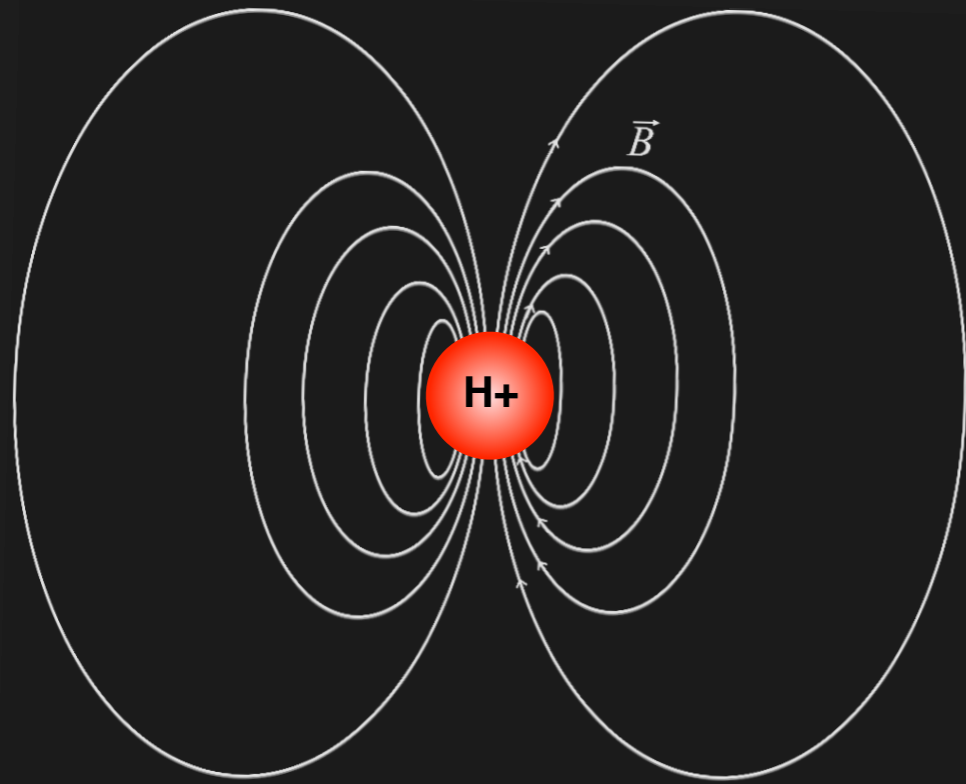

odd mass no

$^1\text{H}$ ,  $^{13}\text{C}$ ,  $^{19}\text{F}$ ,  $^{31}\text{P}$

Spin

Bar magnet

## Water in the body

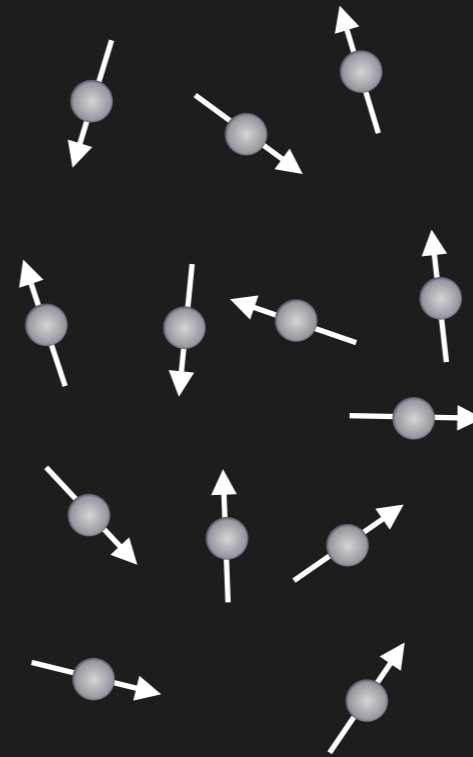

Random



## Nucleus

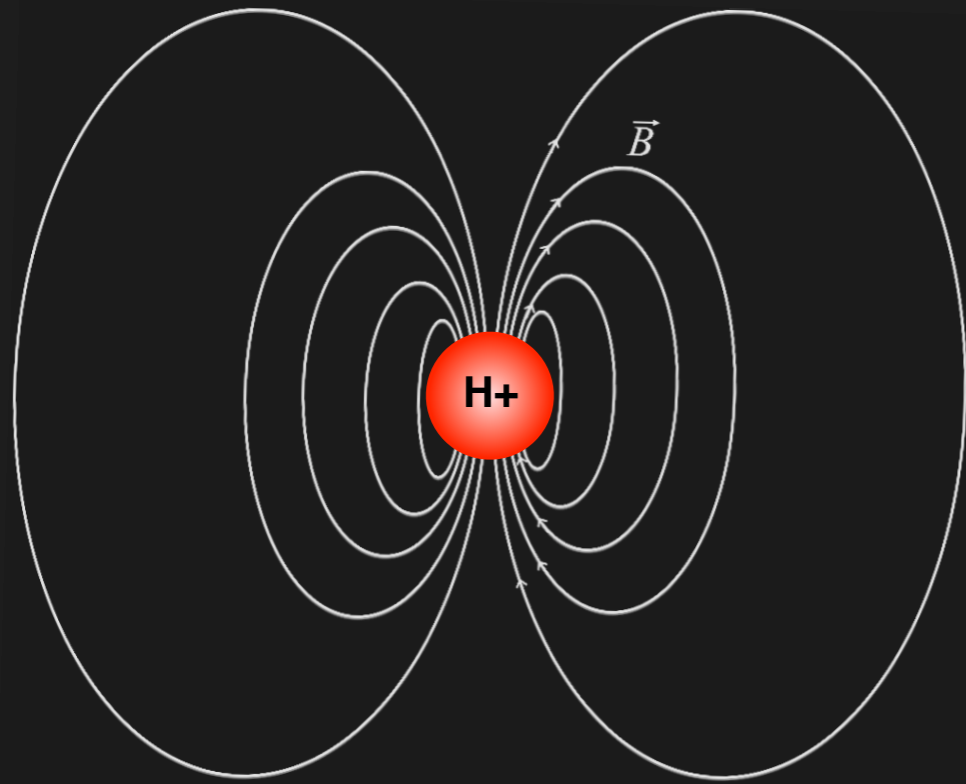

odd mass no

$^1H$ ,  $^{13}C$ ,  $^{19}F$ ,  $^{31}P$

Spin

Bar magnet

## Water in the body

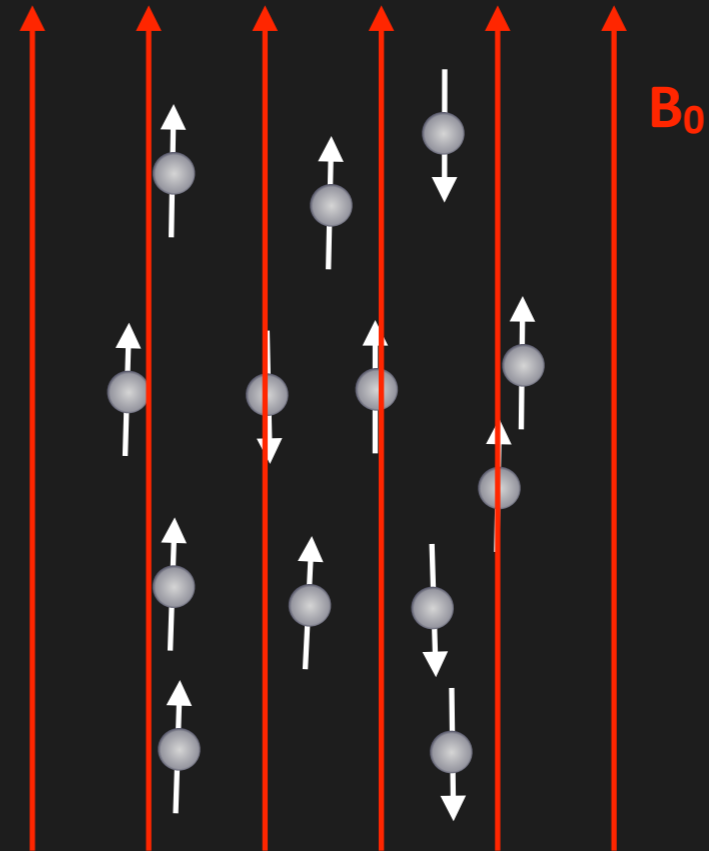

Random

External  $B_0$  applied

## Nucleus

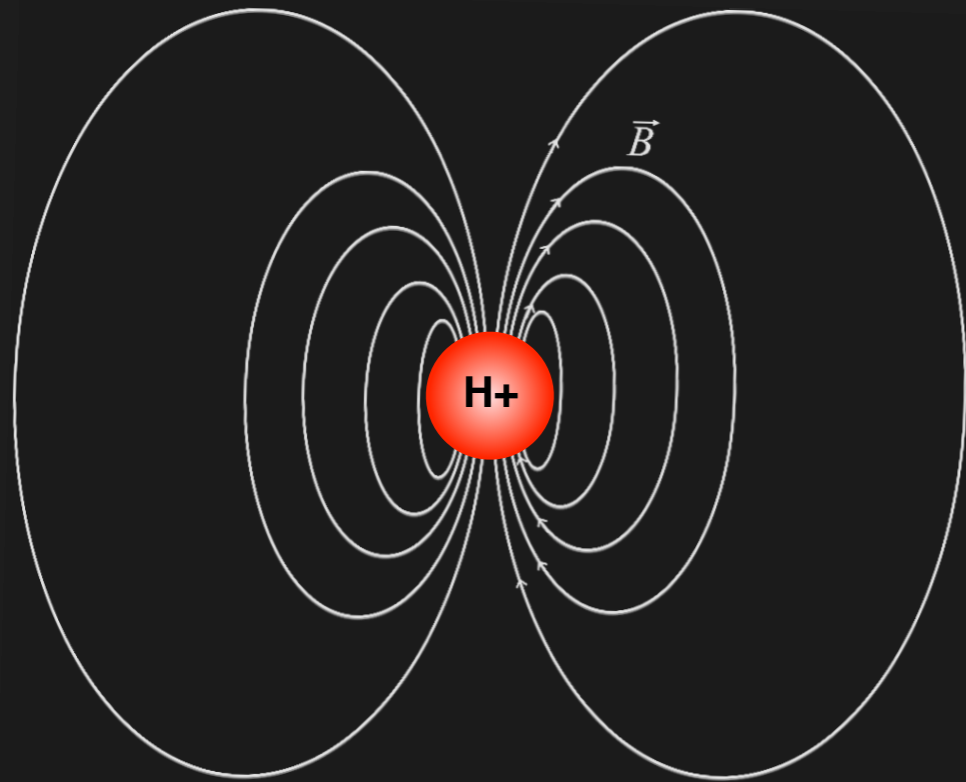

odd mass no

$^1H$ ,  $^{13}C$ ,  $^{19}F$ ,  $^{31}P$

Spin

Bar magnet

## Water in the body

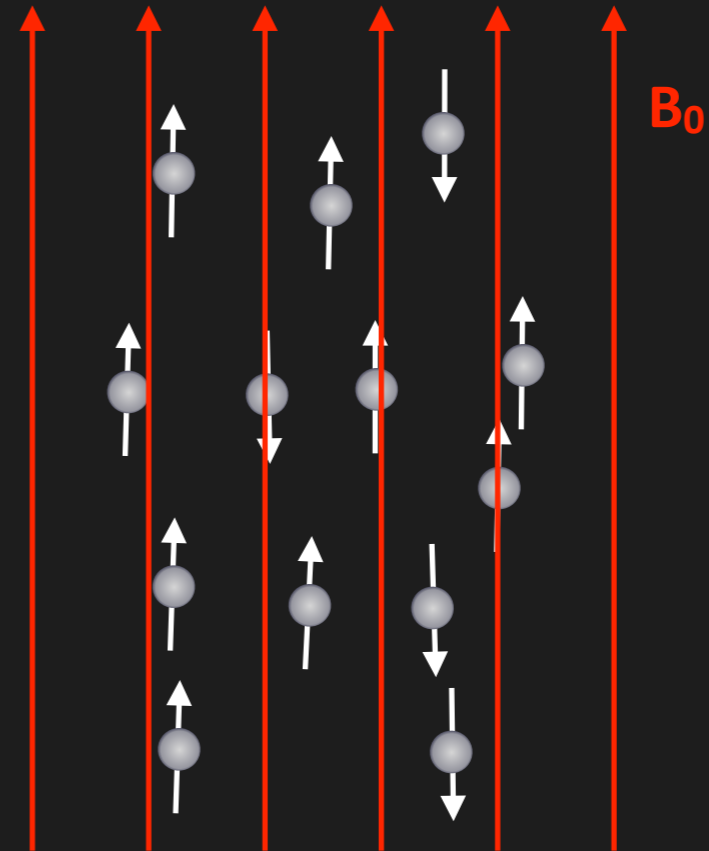

Random

External  $B_0$  applied

Nuclei parallel or anti

## Nucleus

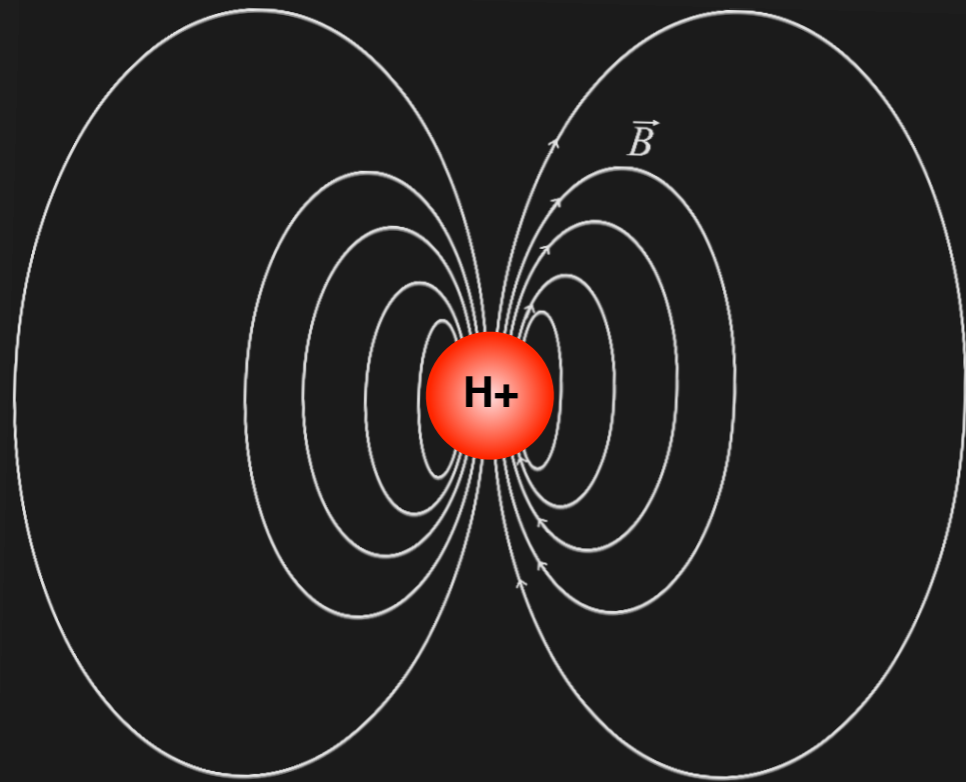

odd mass no

$^1\text{H}$ ,  $^{13}\text{C}$ ,  $^{19}\text{F}$ ,  $^{31}\text{P}$

Spin

Bar magnet

## Water in the body

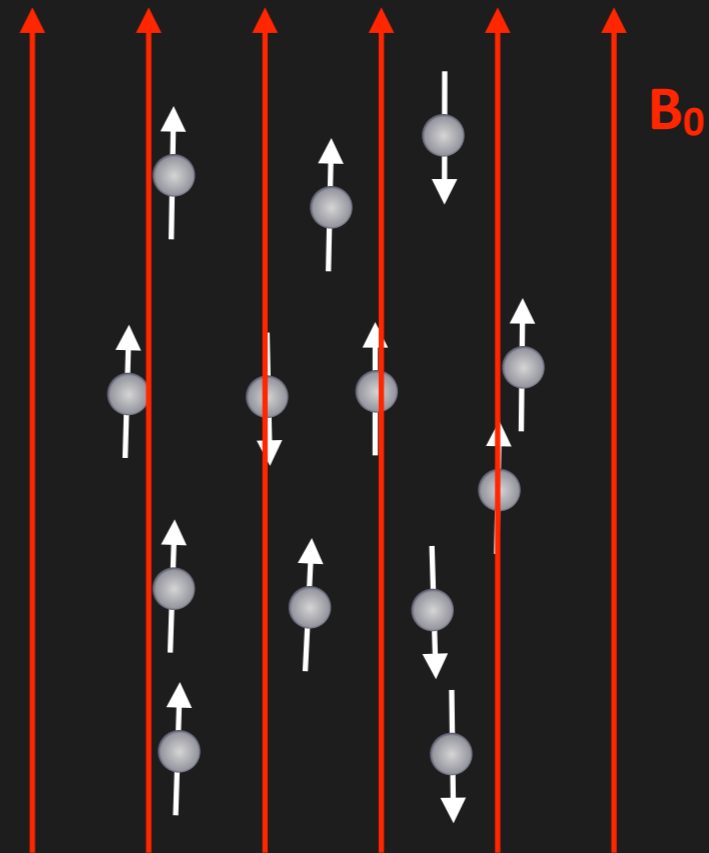

Excess  $\propto B_0$

Random

External  $B_0$  applied

Nuclei parallel or anti

## Nucleus

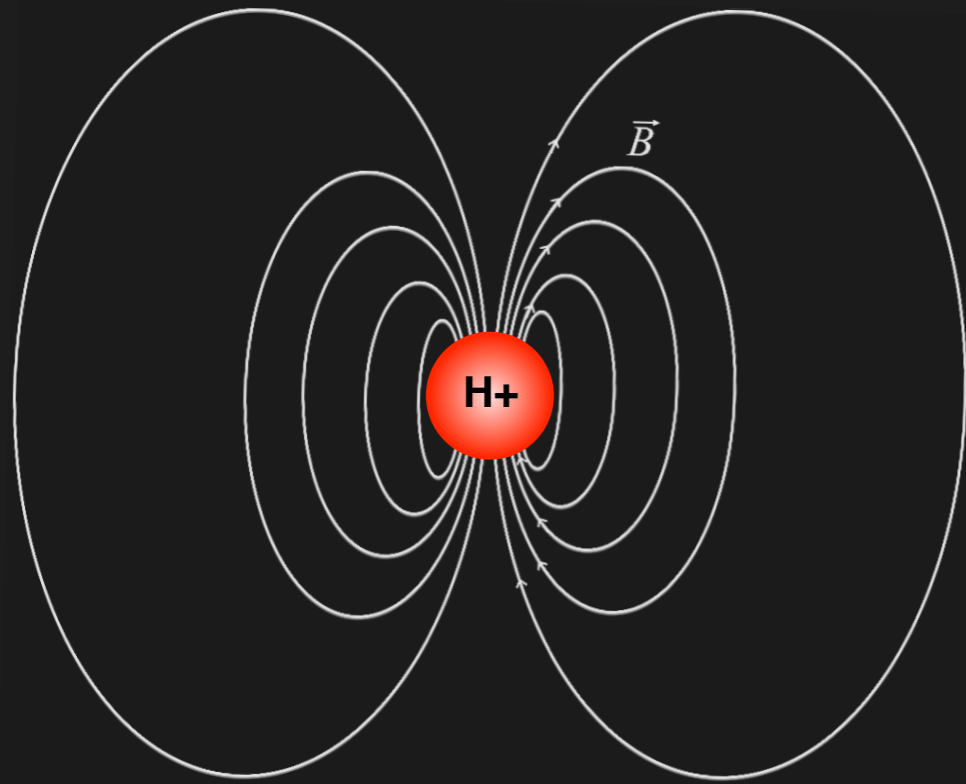

odd mass no

$^1\text{H}$ ,  $^{13}\text{C}$ ,  $^{19}\text{F}$ ,  $^{31}\text{P}$

Spin

Bar magnet

## Water in the body

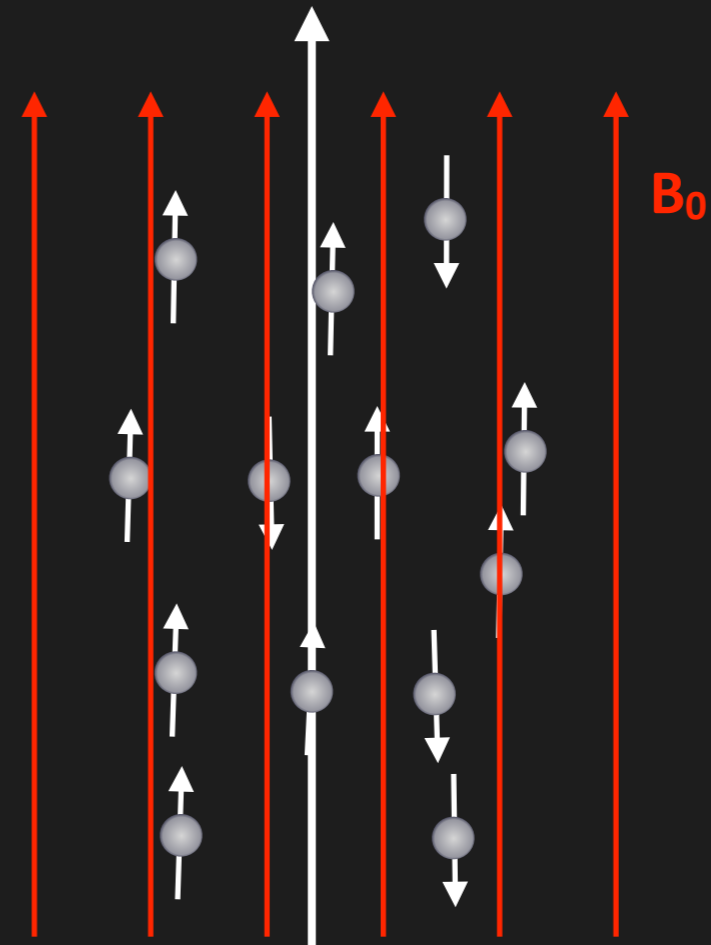

NMV

Random

External  $B_0$  applied

Nuclei parallel or anti



Preprocessing



Preprocessing



Precessing

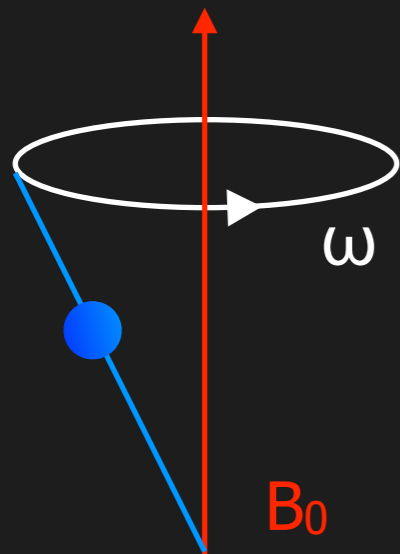

$$\omega = \gamma B_0$$

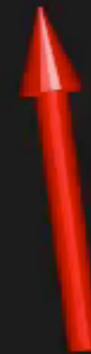
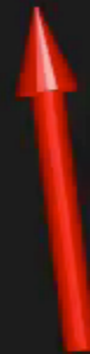

Precessing

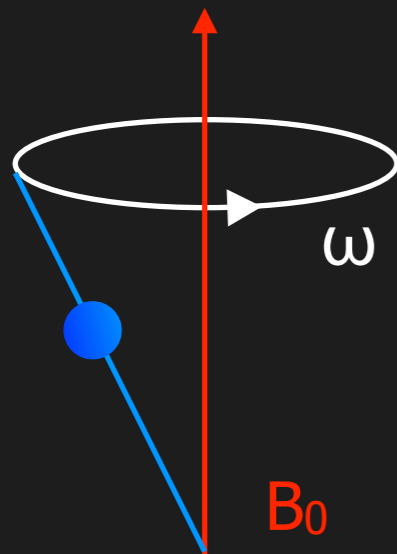
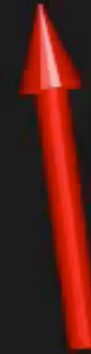
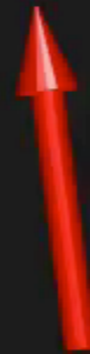

$$\omega = \gamma B_0$$





Precessing

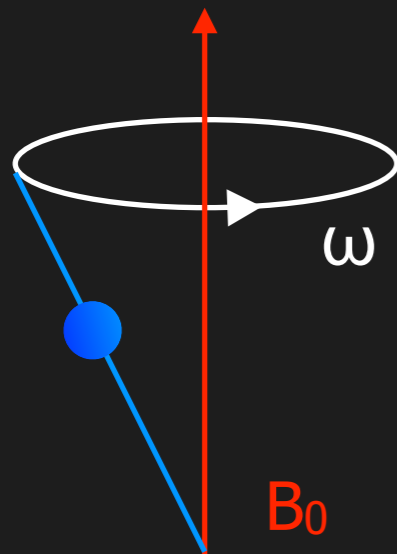

Same frequency - different phase

$$\omega = \gamma B_0$$

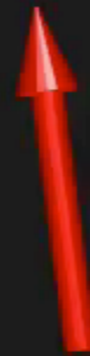

Precessing

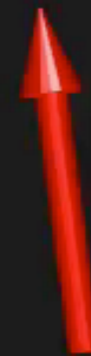
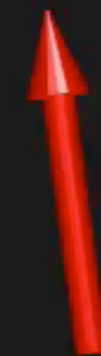
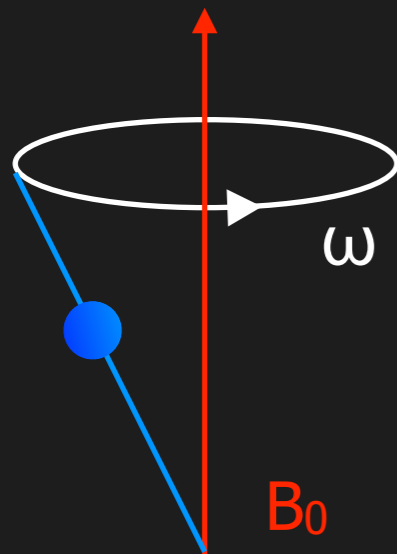

Same frequency - different phase

No net x-y component

$$\omega = \gamma B_0$$





Resonance tip NMV into x-y



Resonance tip NMV into x-y



Impart energy

Resonance tip NMV into x-y



Impart energy

EM radiation at Larmor

Resonance tip NMV into x-y



Impart energy

EM radiation at Larmor

63 MHz - radio waves



Resonance tip NMV into x-y

Why is this useful



Impart energy

EM radiation at Larmor

63 MHz - radio waves

Resonance tip NMV into x-y



Why is this useful



Impart energy

EM radiation at Larmor

63 MHz - radio waves

Induces current in antenna

Resonance tip NMV into x-y



Why is this useful



Impart energy

EM radiation at Larmor

63 MHz - radio waves

Induces current in antenna

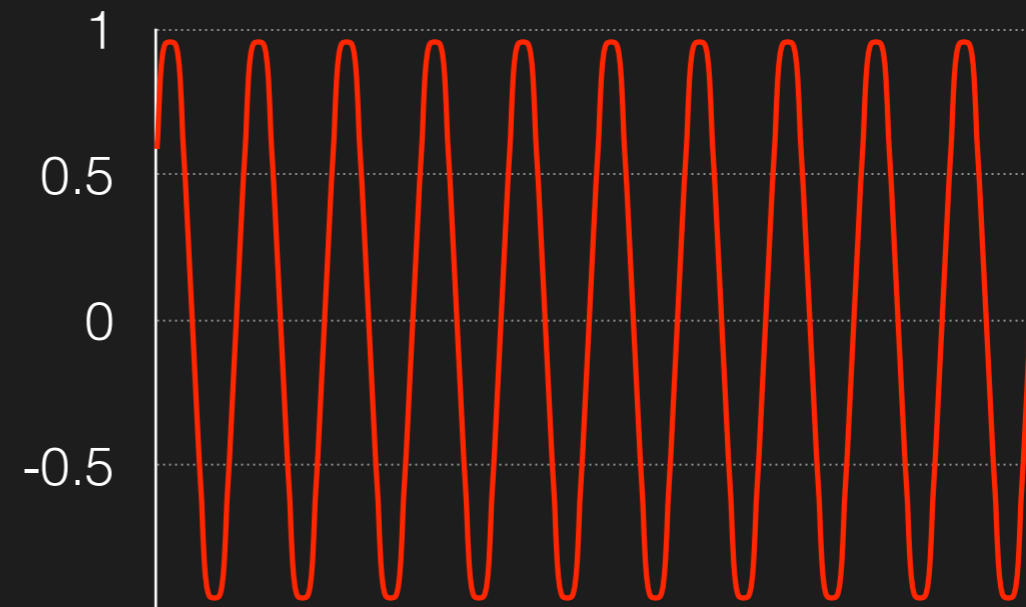



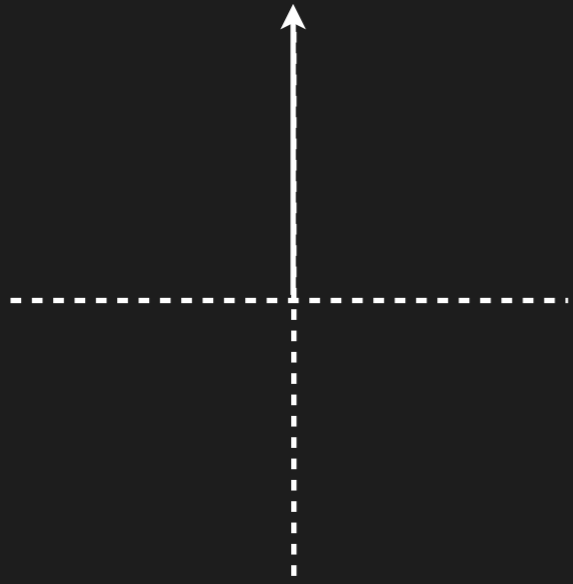

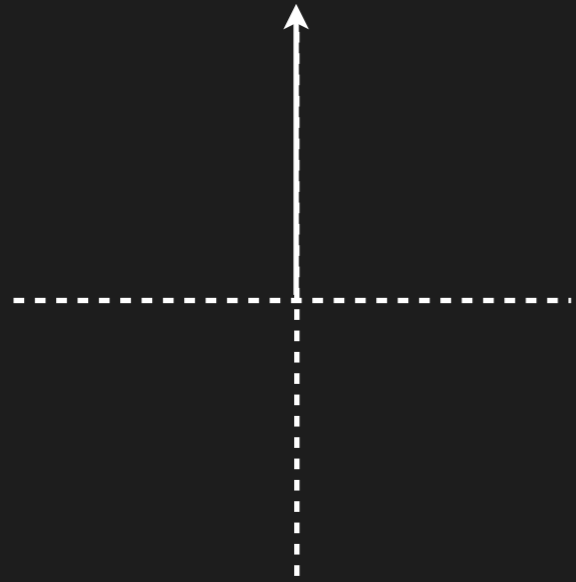

**Rotating frame of reference**

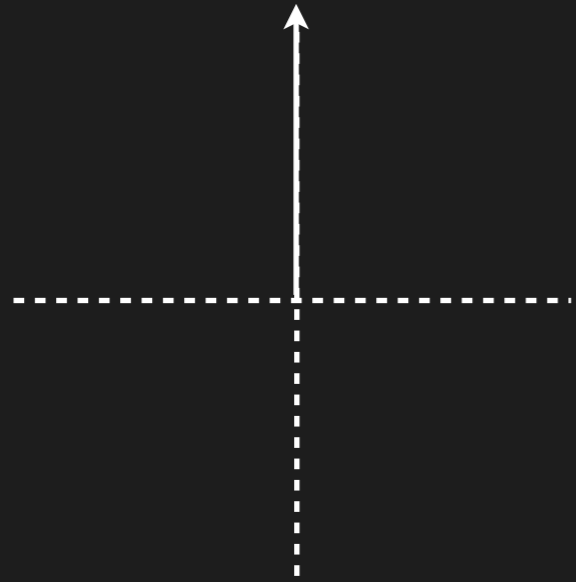

**Rotating frame of reference**

**MR signal hand on a clock**

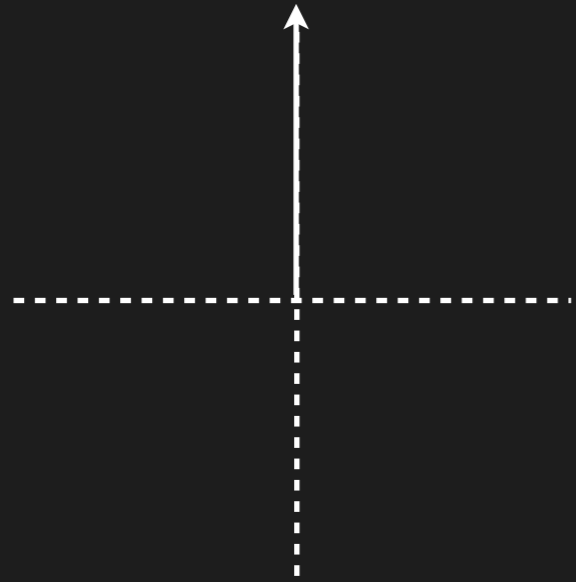

**Rotating frame of reference**

**MR signal hand on a clock**

**Length**



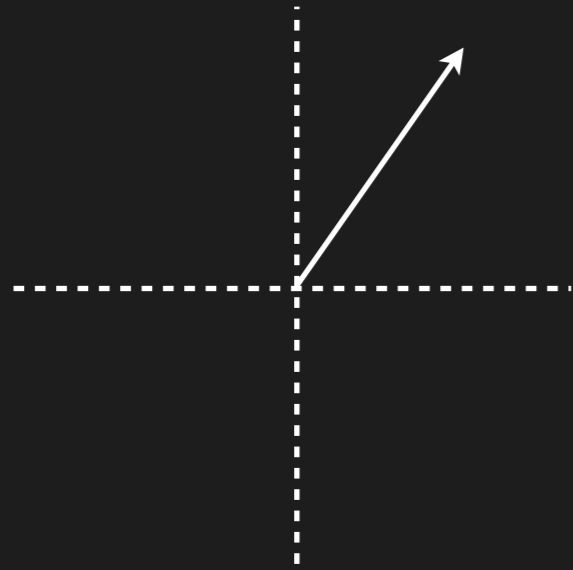

**Rotating frame of reference**

**MR signal hand on a clock**

**Length**

**Angle**

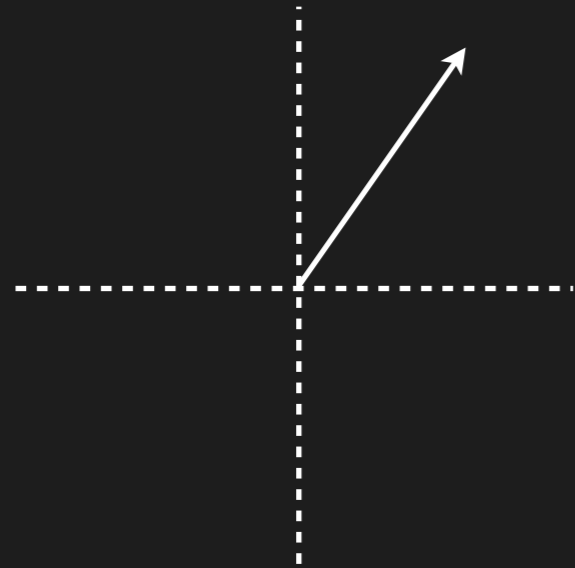

Where

Rotating frame of reference

MR signal hand on a clock

Length

Angle

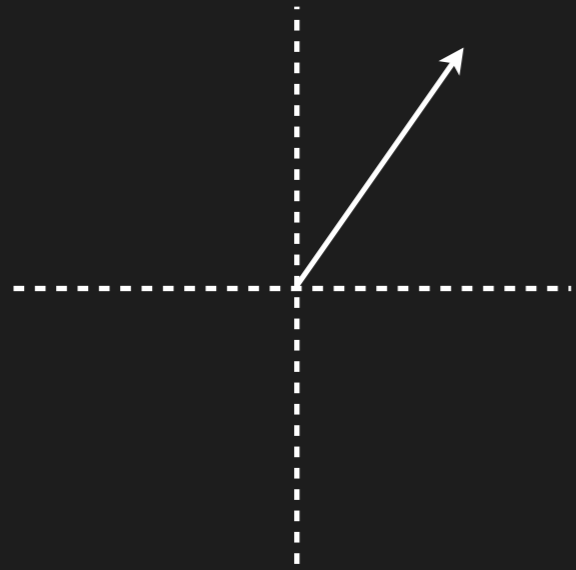

**Where**



**Angle**

**Rotating frame of reference**

**MR signal hand on a clock**

**Length**

**Angle**

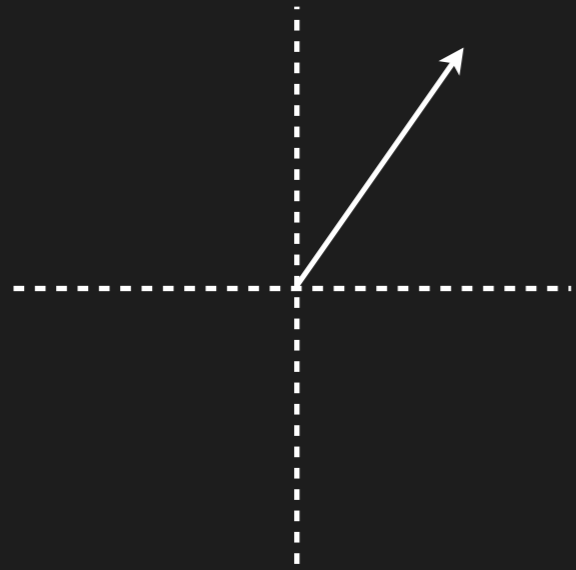

**Where**



**Angle**



**Gradients**

**Rotating frame of reference**

**MR signal hand on a clock**

**Length**

**Angle**

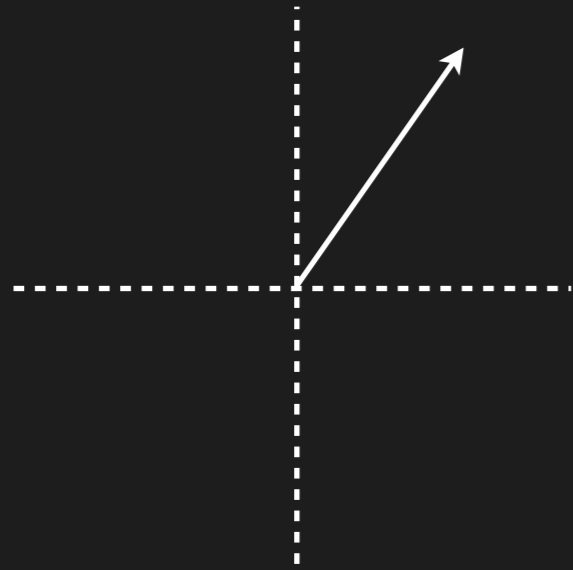

**Where**

**What**

**Angle**

**Gradients**

**Rotating frame of reference**

**MR signal hand on a clock**

**Length**

**Angle**

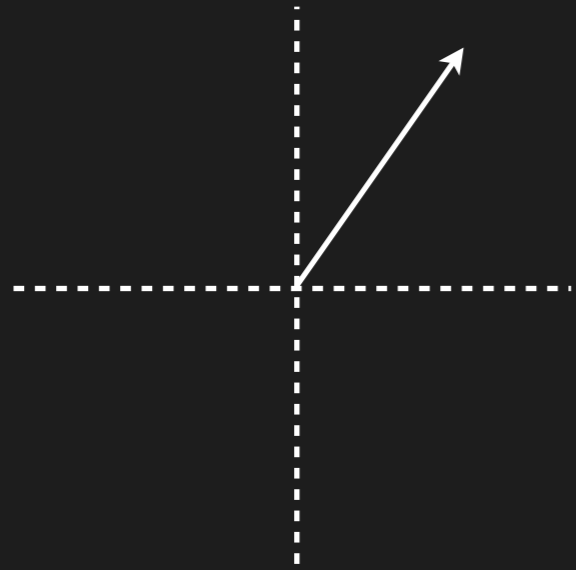

**Where**

**What**

**Angle**

**Length**

**Rotating frame of reference**

**MR signal hand on a clock**

**Length**

**Angle**

**Gradients**

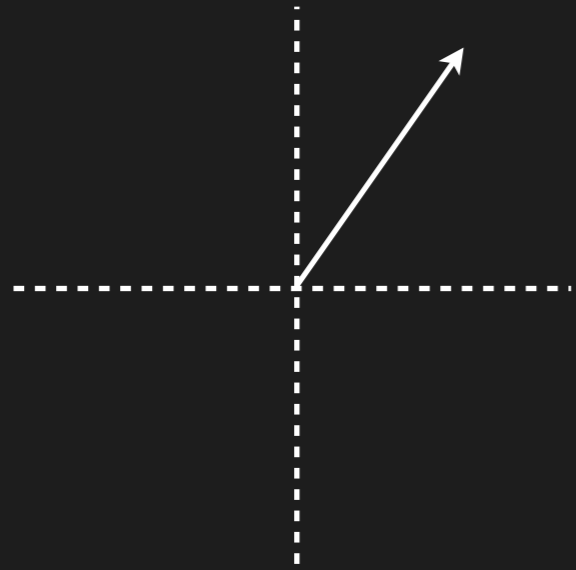

**Where**

**What**

**Angle**

**Length**

**Rotating frame of reference**

**MR signal hand on a clock**

**Length**

**Angle**

**Gradients**

**Timing**

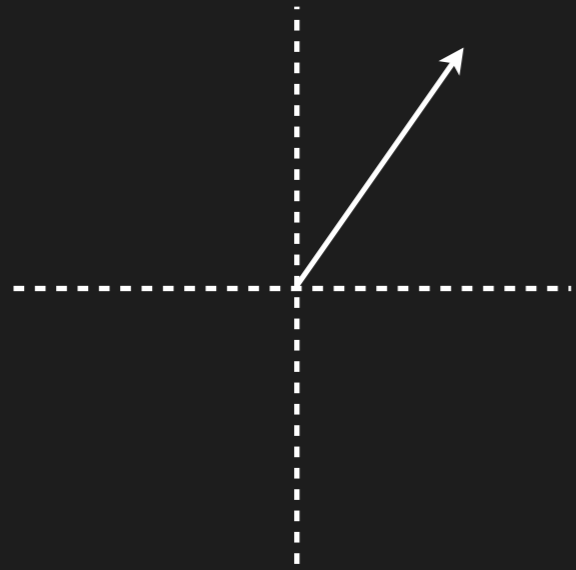

**Where**

**What**

**Angle**

**Length**

**Rotating frame of reference**

**MR signal hand on a clock**

**Length**

**Angle**

**Gradients**

**Timing**

**MRI made simple**



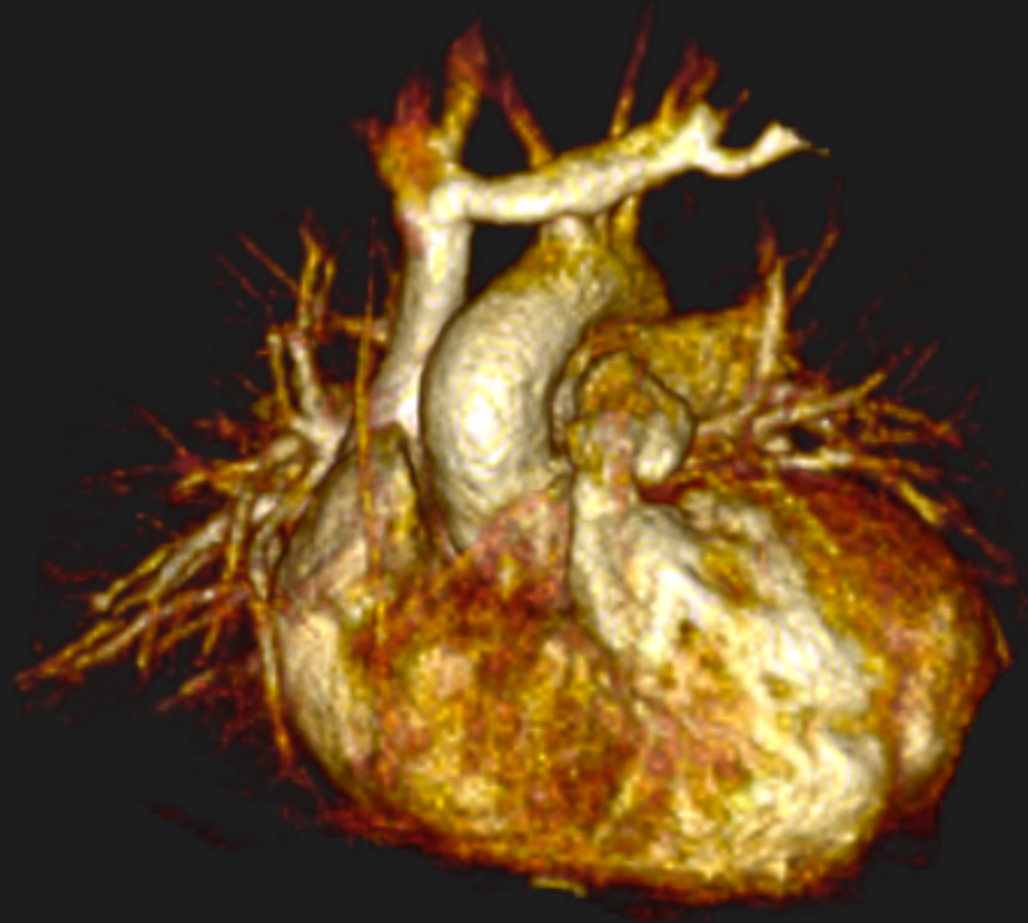

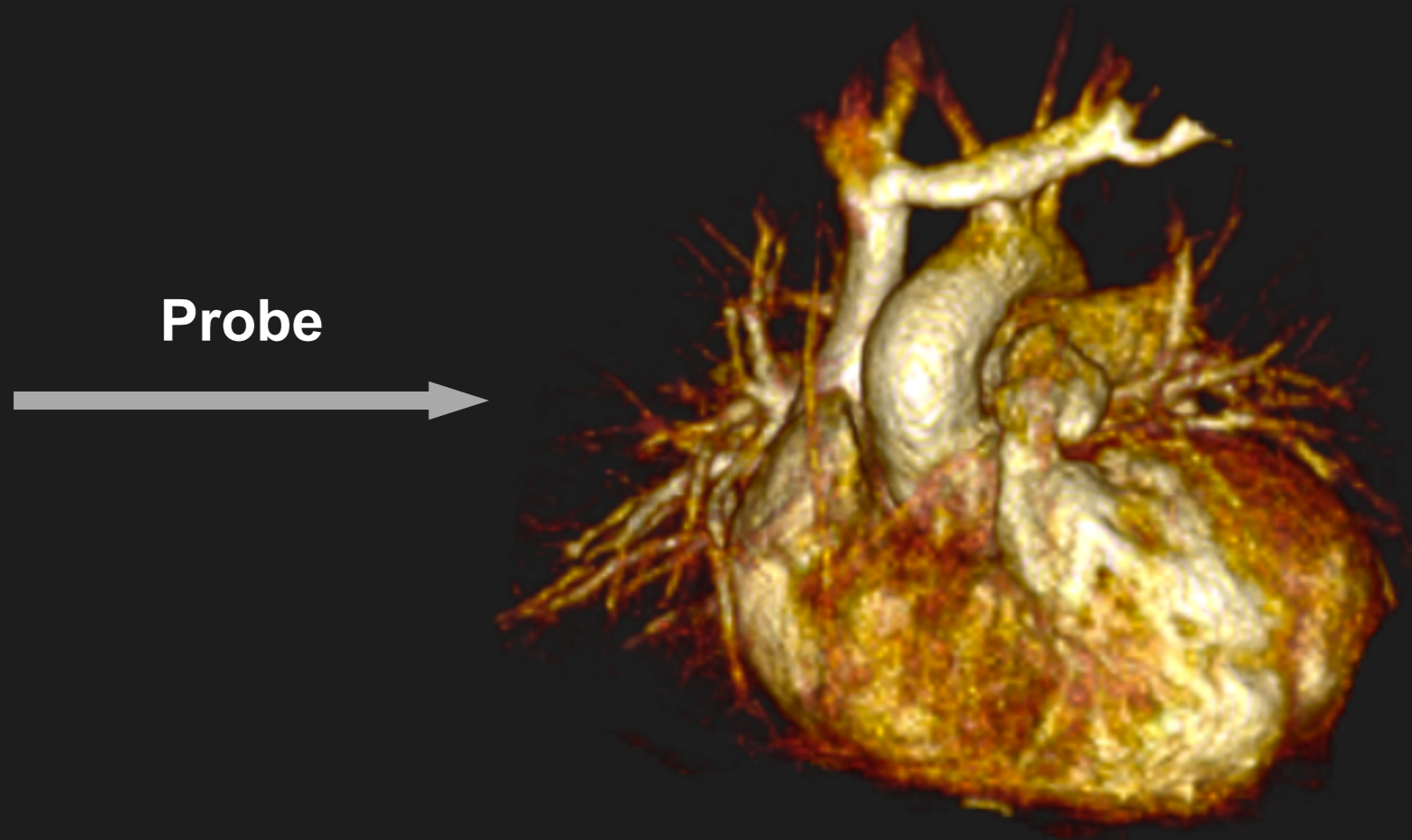

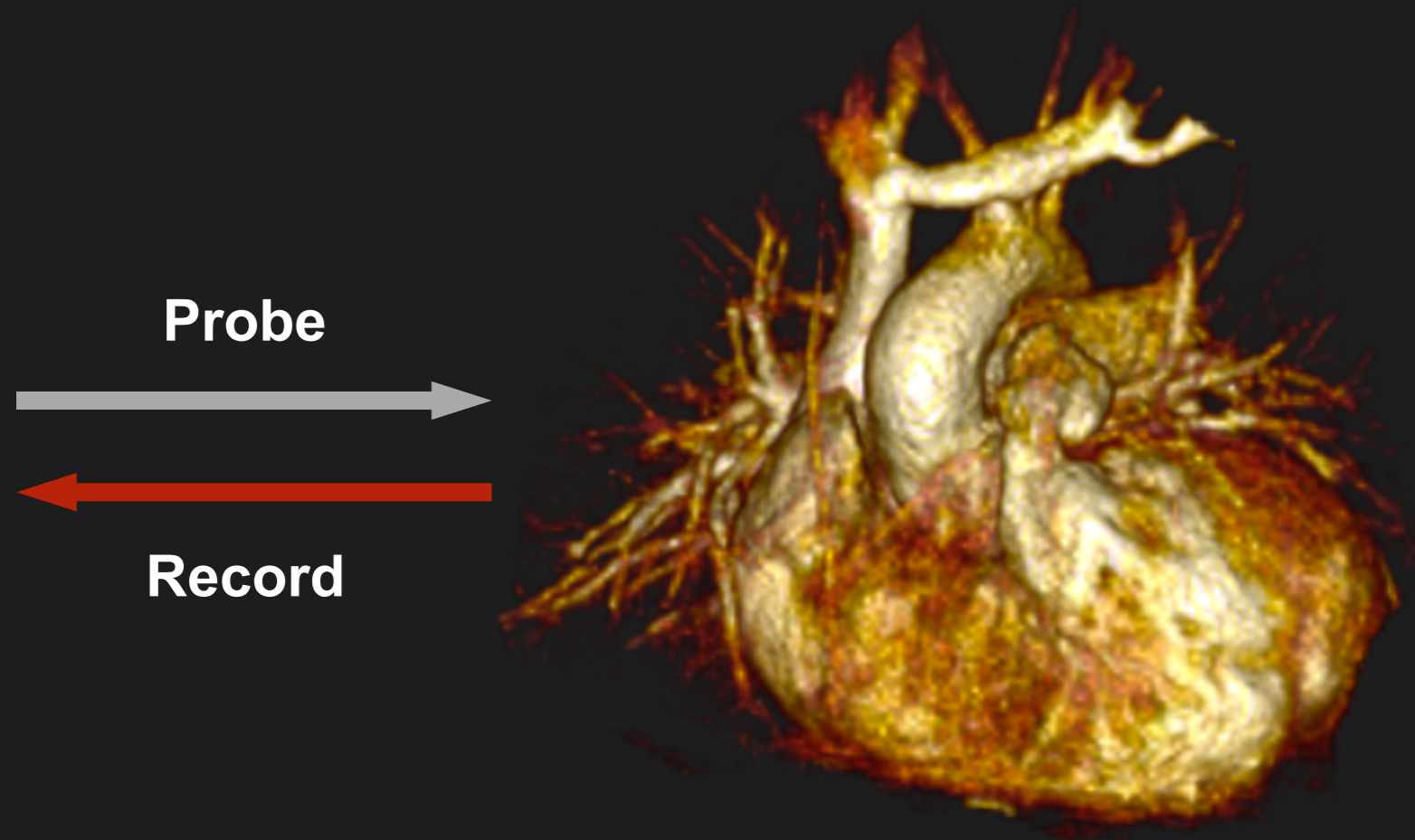

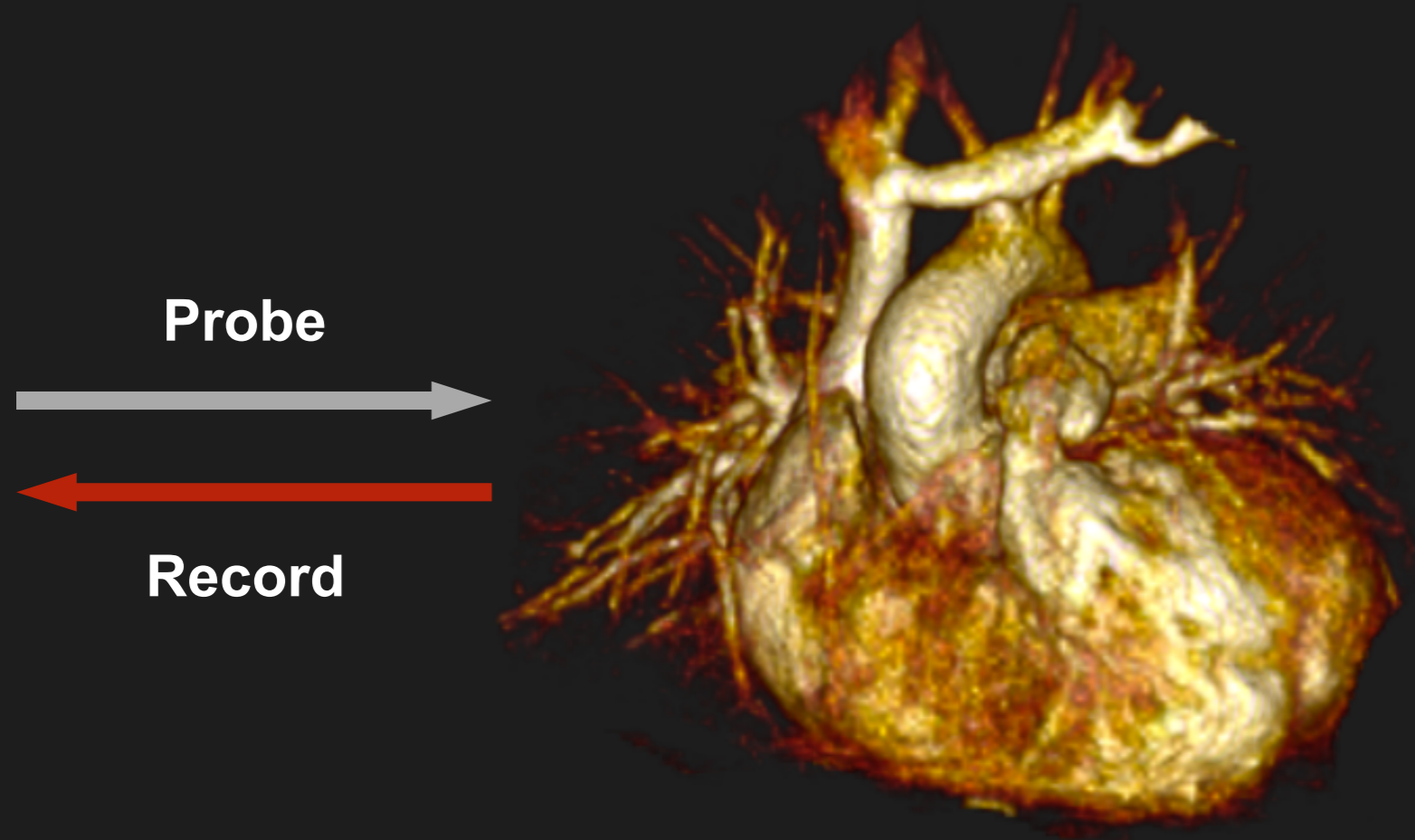

**More info - more probes**

Image 100 pixels

100 independent experiments

**X-ray**

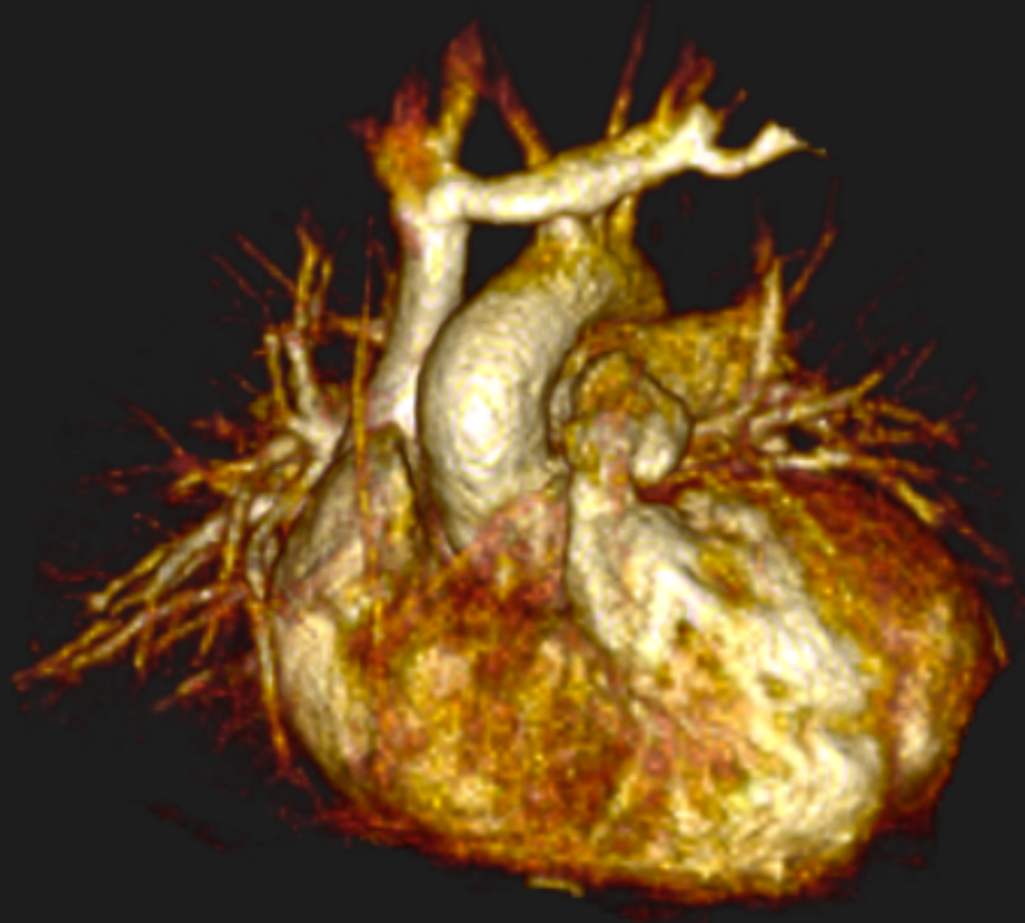

X-ray

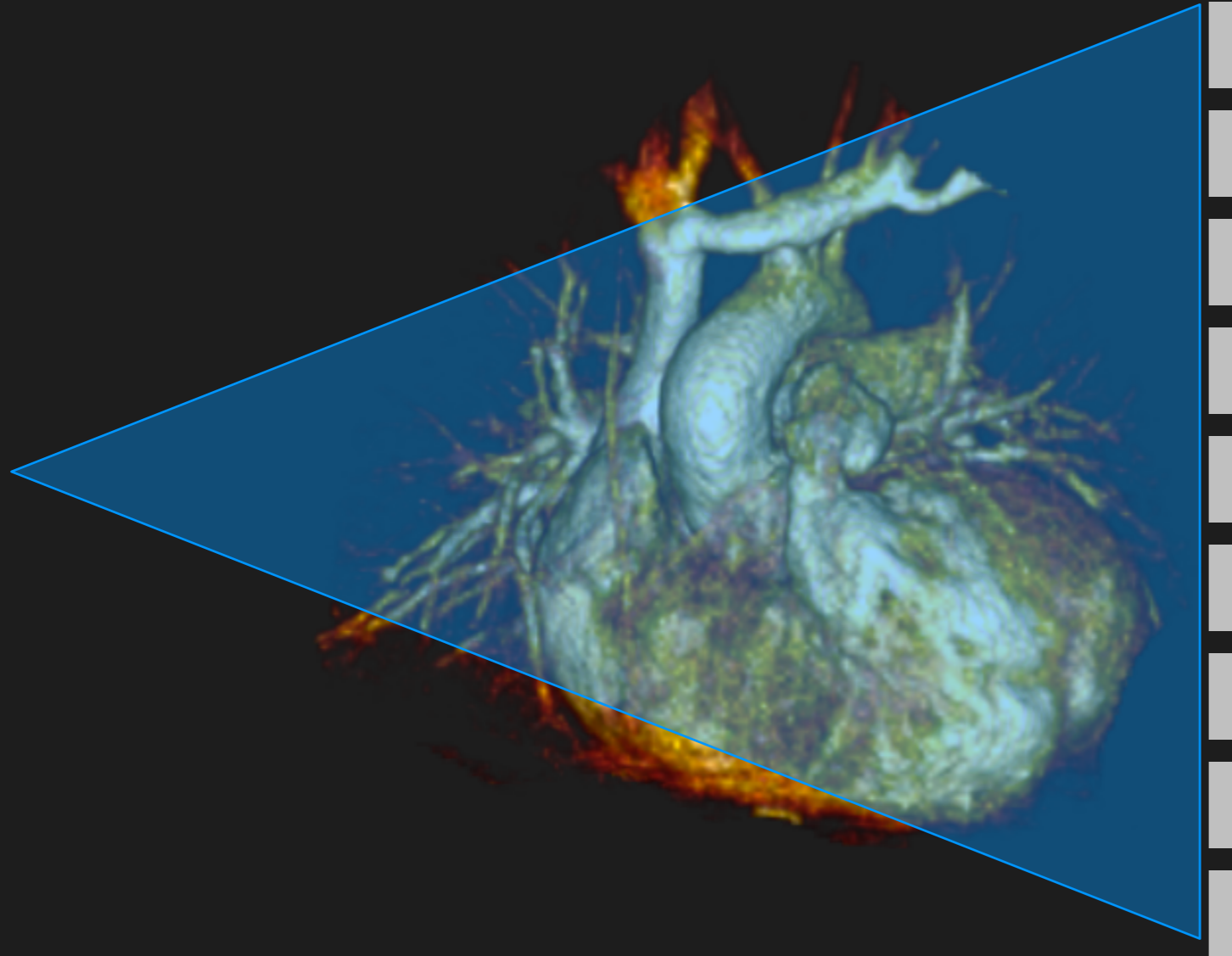

**X-ray**

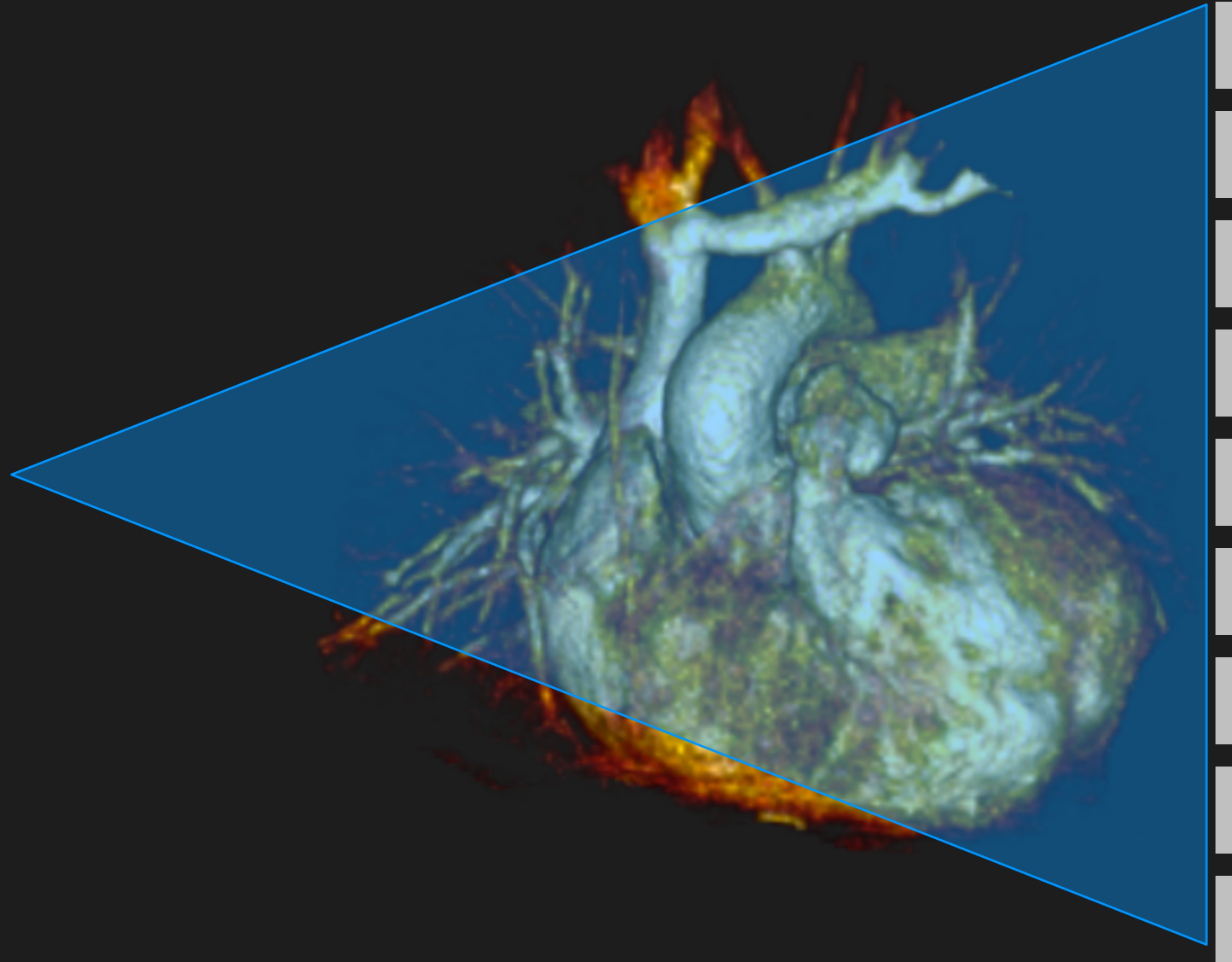

## **X-ray/angio**

Each detector - experiment

Spatially independent

Sampling done concurrently

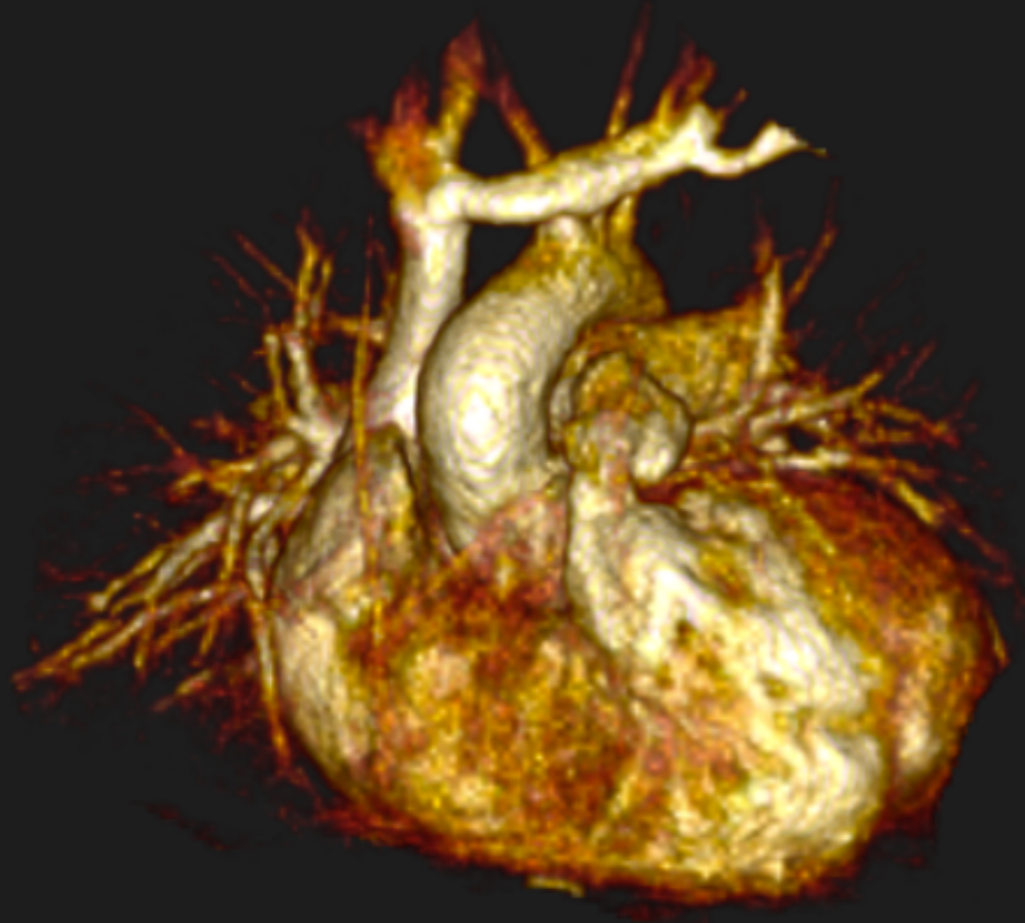

## X-ray/angio

Each detector - experiment

Spatially independent

Sampling done concurrently



## X-ray/angio

Each detector - experiment

Spatially independent

Sampling done concurrently

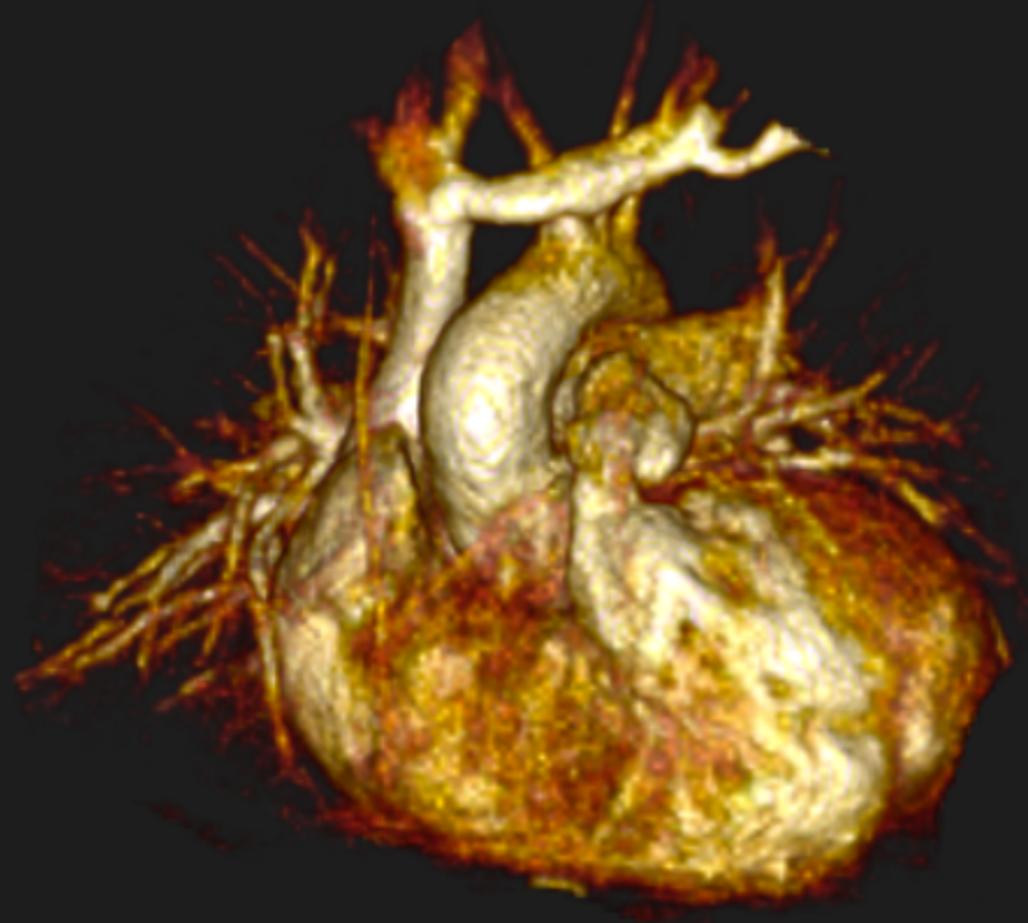

**MRI**

RF

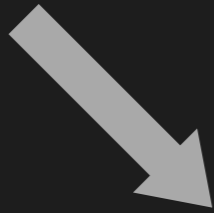

MRI

## X-ray/angio

Each detector - experiment

Spatially independent

Sampling done concurrently

**RF**

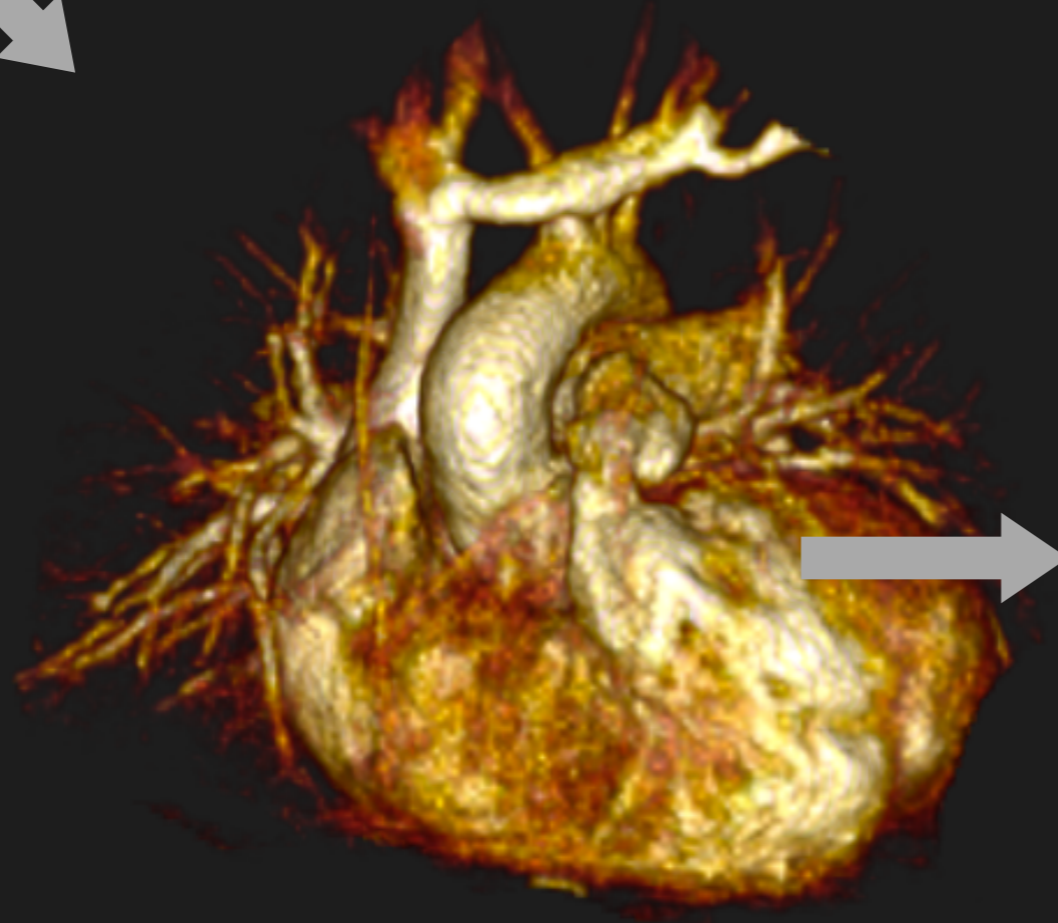
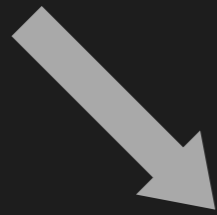

**X-ray/angio**  
Each detector - experiment  
Spatially independent  
Sampling done concurrently

**Signal**

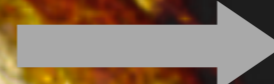

**MRI**

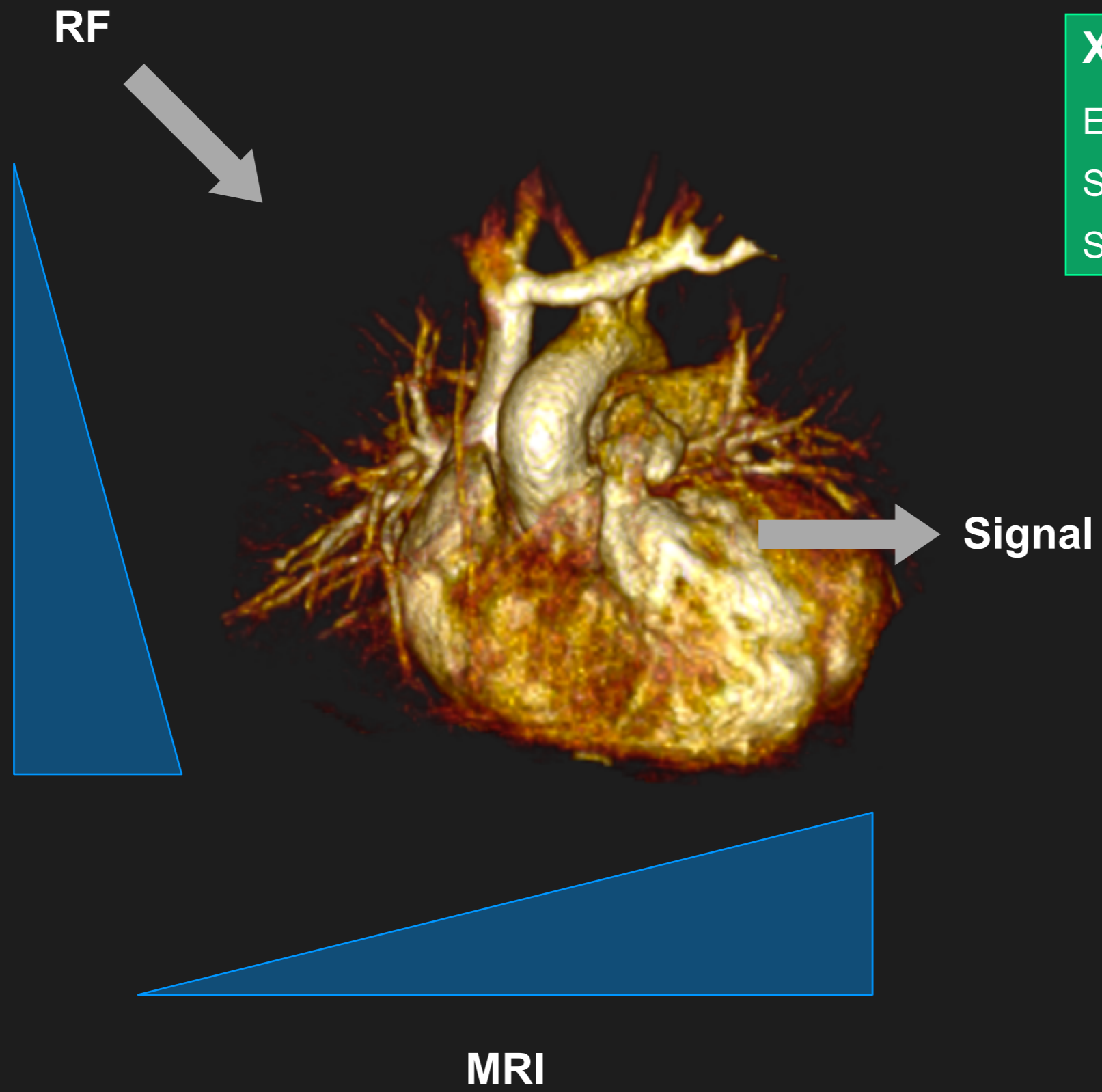

**X-ray/angio**

- Each detector - experiment
- Spatially independent
- Sampling done concurrently

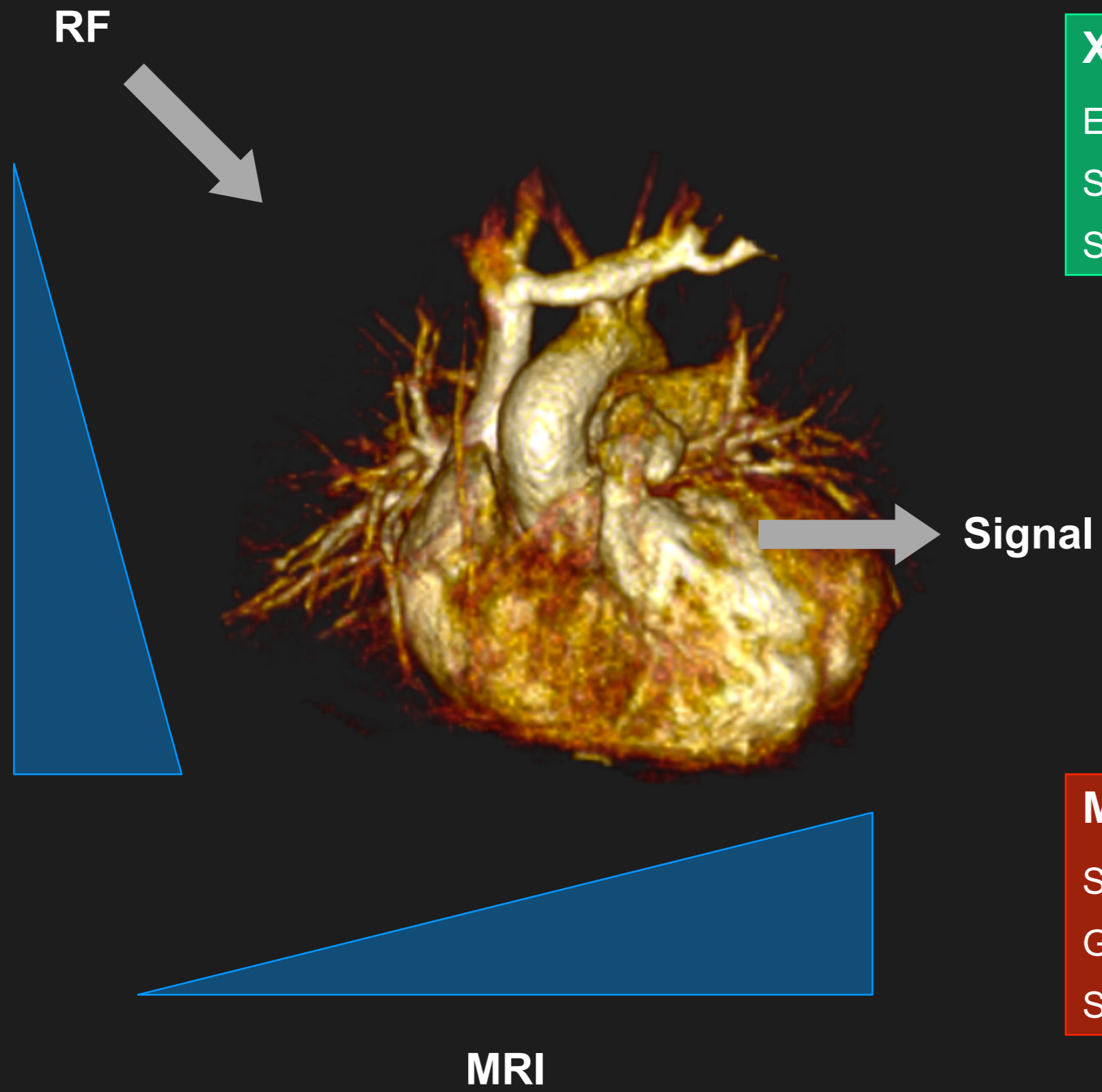

**X-ray/angio**

- Each detector - experiment
- Spatially independent
- Sampling done concurrently

**MRI**

- Single detector
- Gradients - Experiments
- Sampling done consecutively

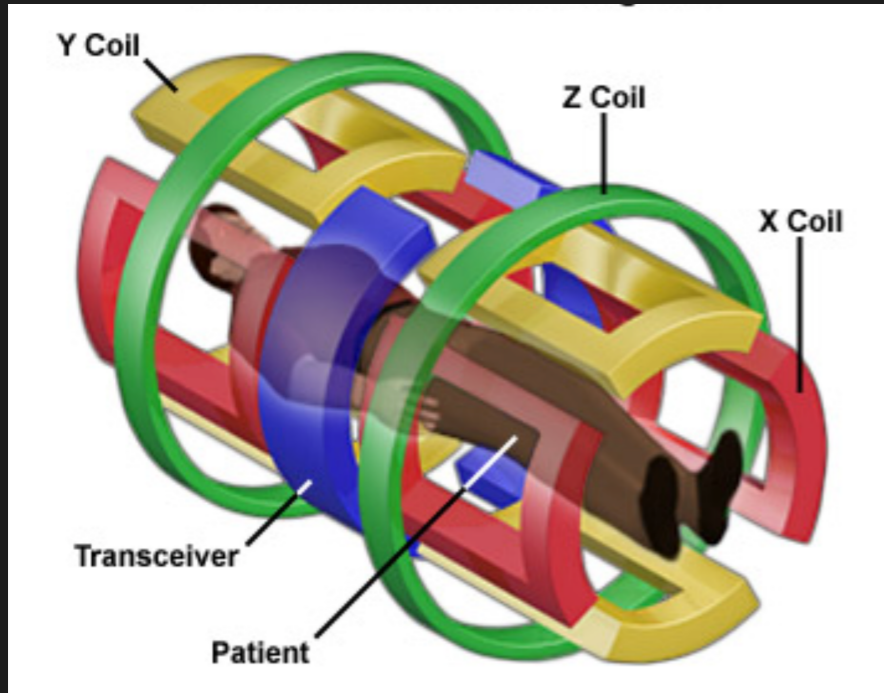

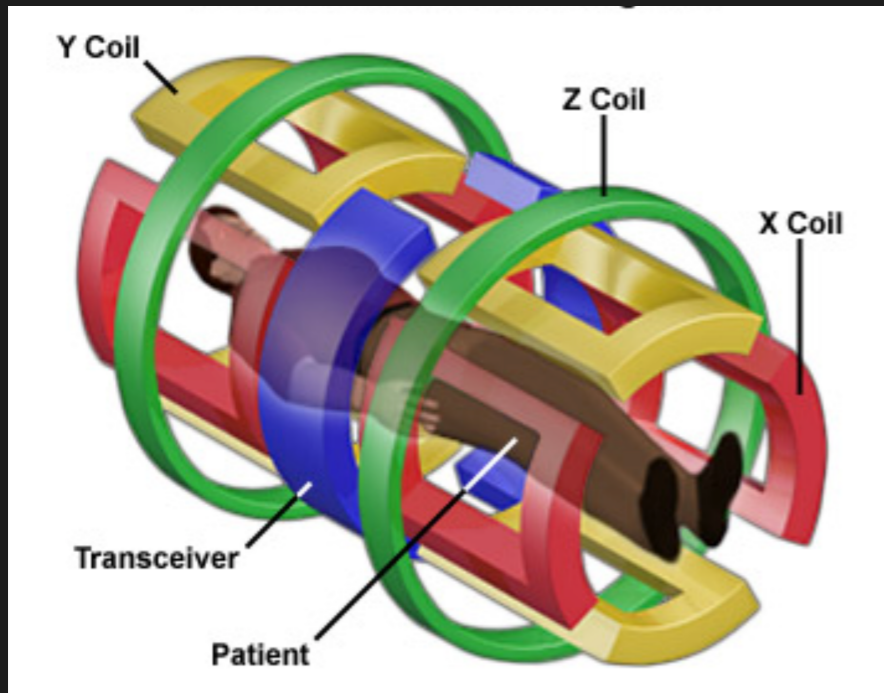

Create additional field

3 orthogonal coils

Any double oblique gradient

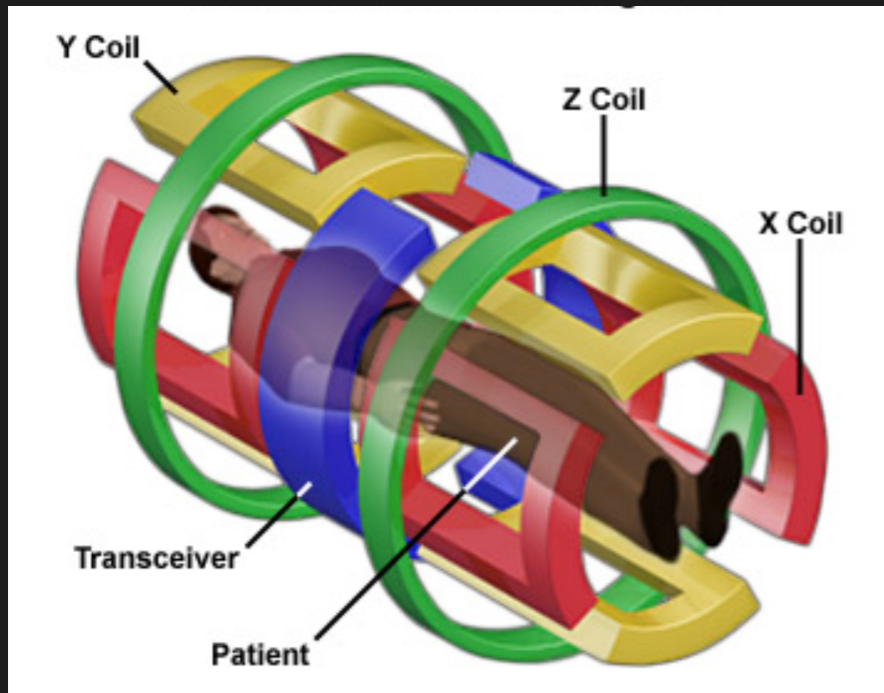

Create additional field

3 orthogonal coils

Any double oblique gradient

Use most energy



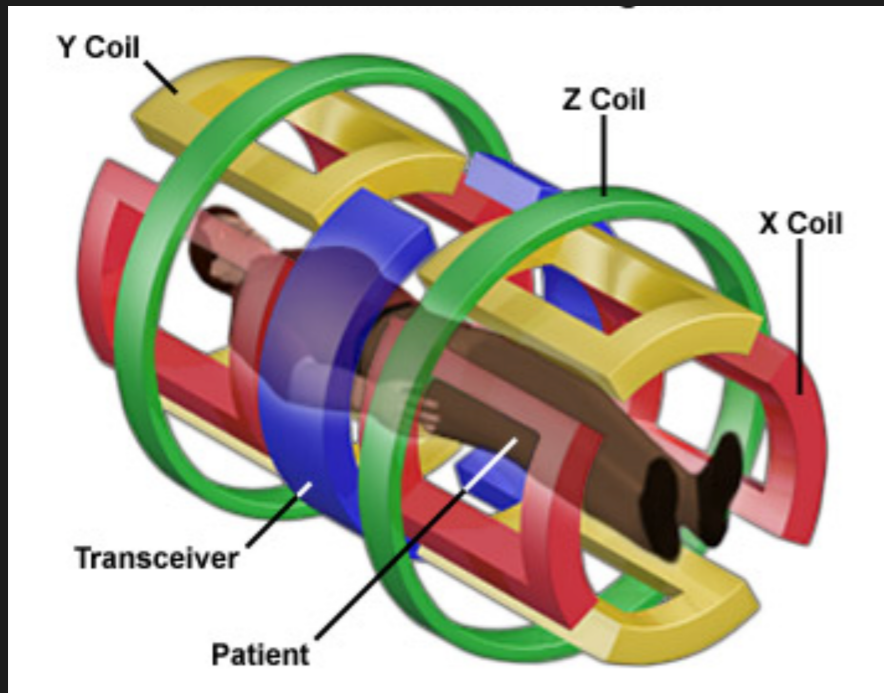

Create additional field

3 orthogonal coils

Any double oblique gradient

Use most energy

Make all the noise

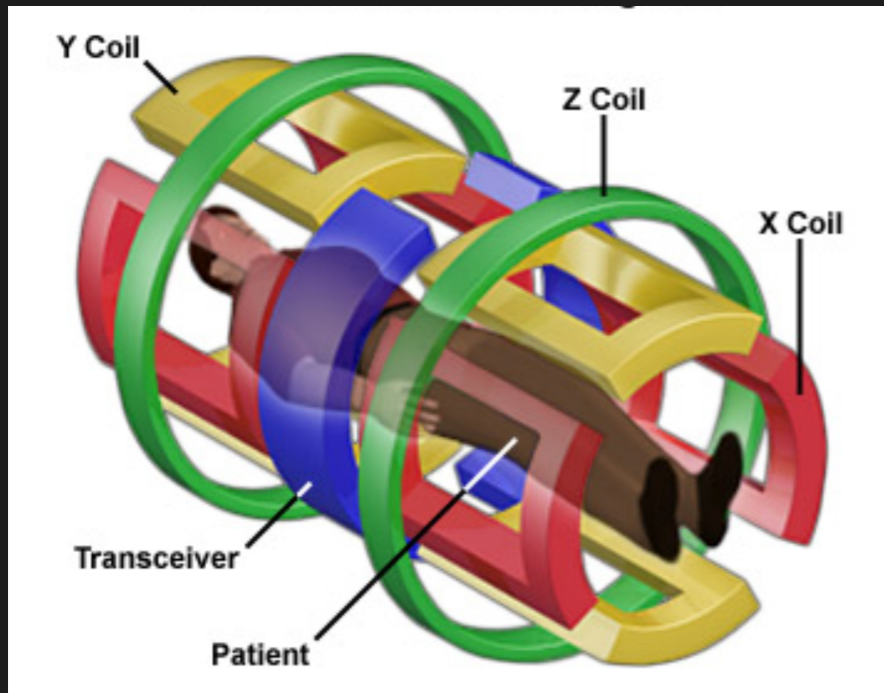

Create additional field

3 orthogonal coils

Any double oblique gradient

Use most energy

Make all the noise

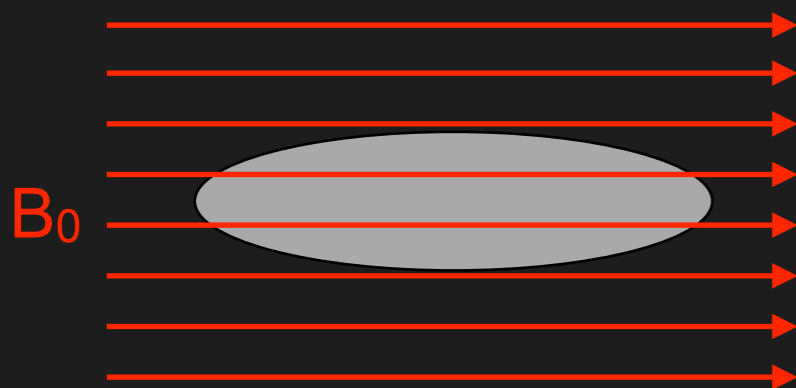

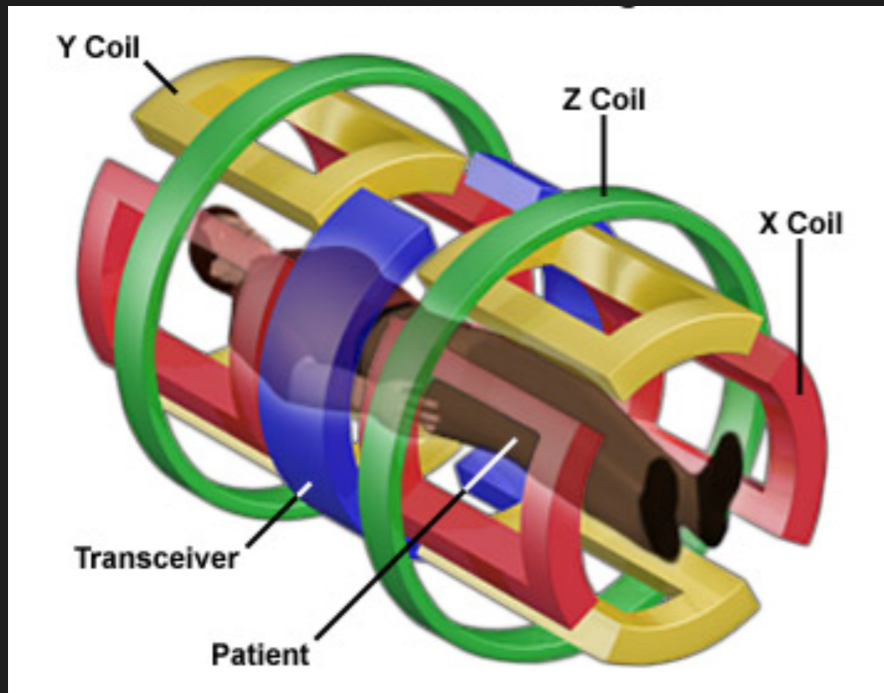

Create additional field

3 orthogonal coils

Any double oblique gradient

Use most energy

Make all the noise

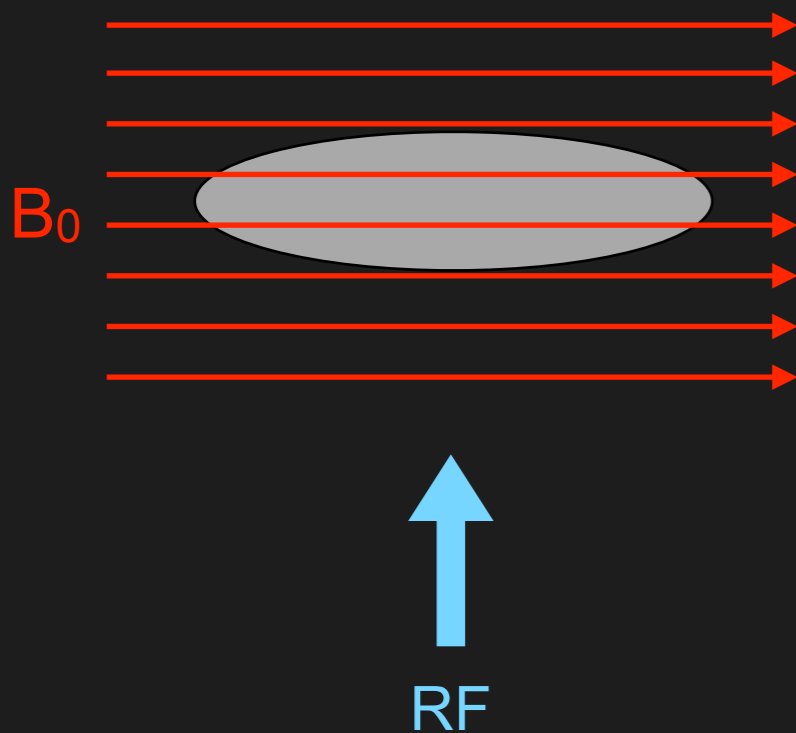

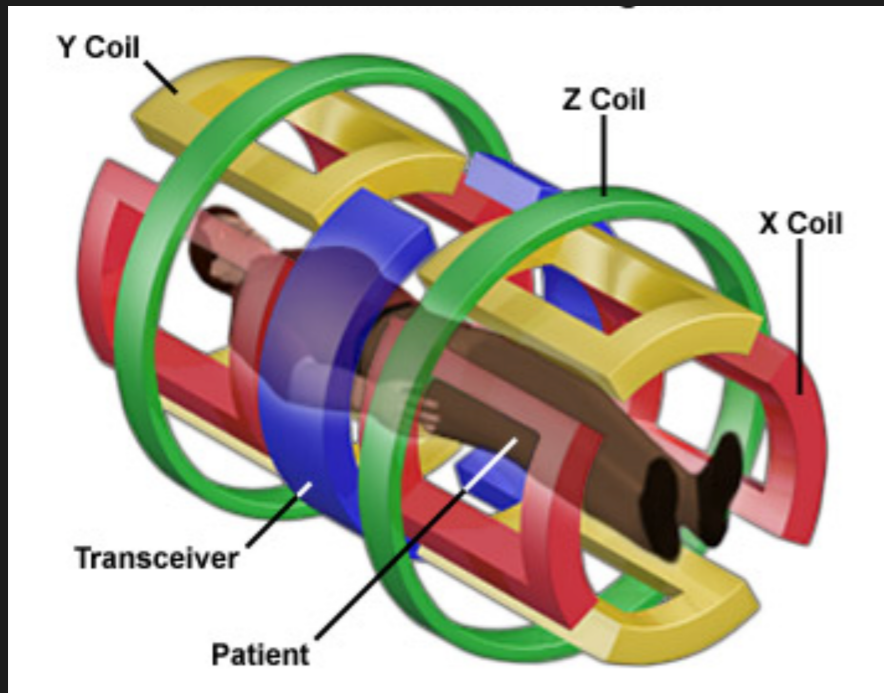

Create additional field

3 orthogonal coils

Any double oblique gradient

Use most energy

Make all the noise

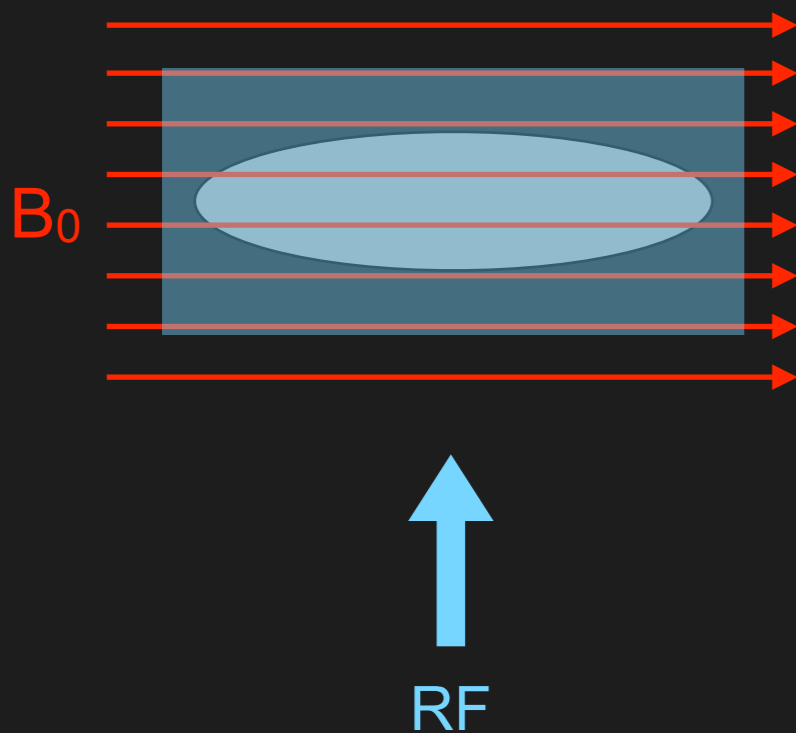

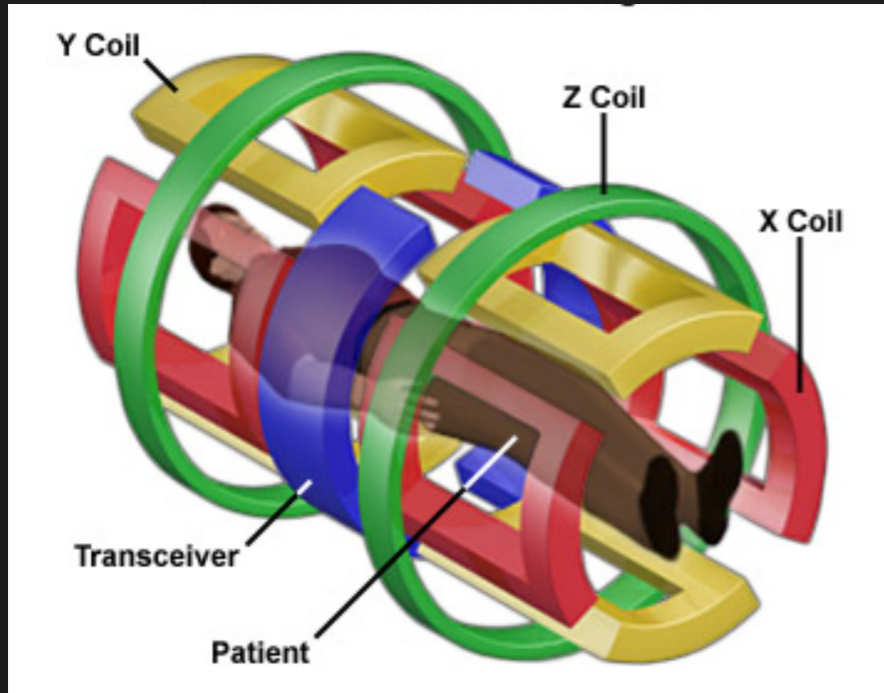

Create additional field

3 orthogonal coils

Any double oblique gradient

Use most energy

Make all the noise

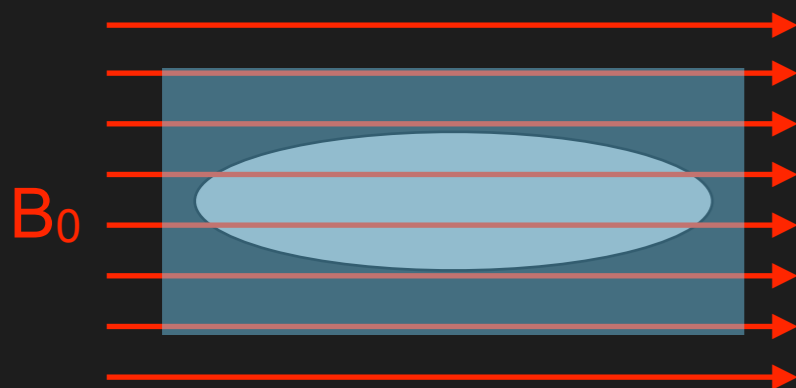

Signal from whole object

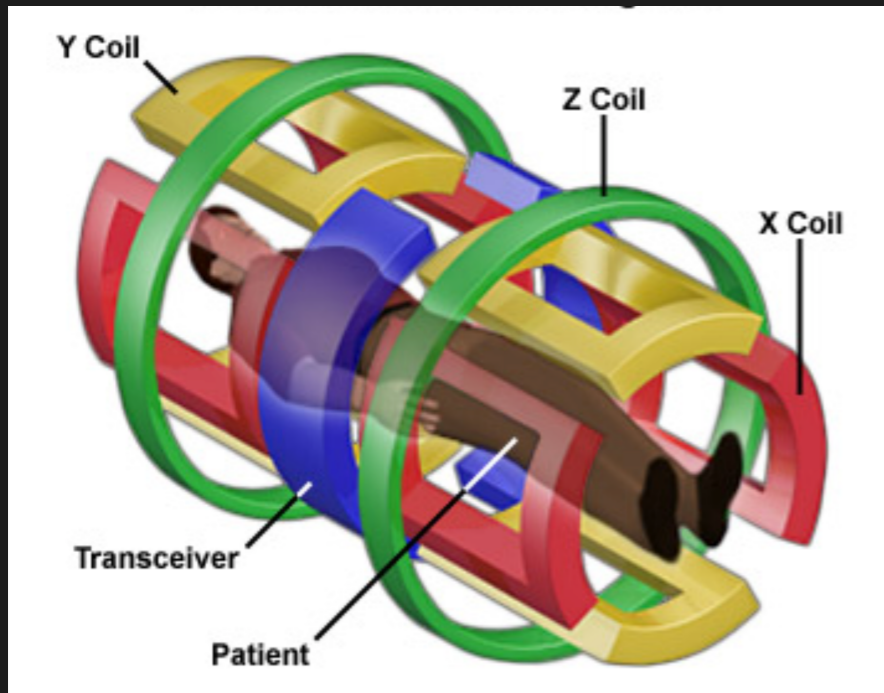

Create additional field

3 orthogonal coils

Any double oblique gradient

Use most energy

Make all the noise

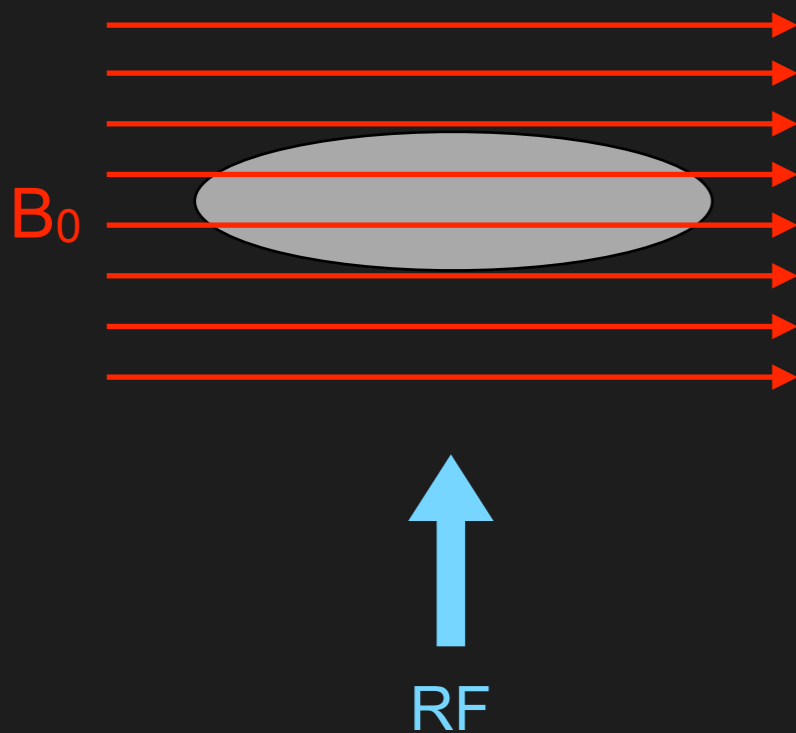

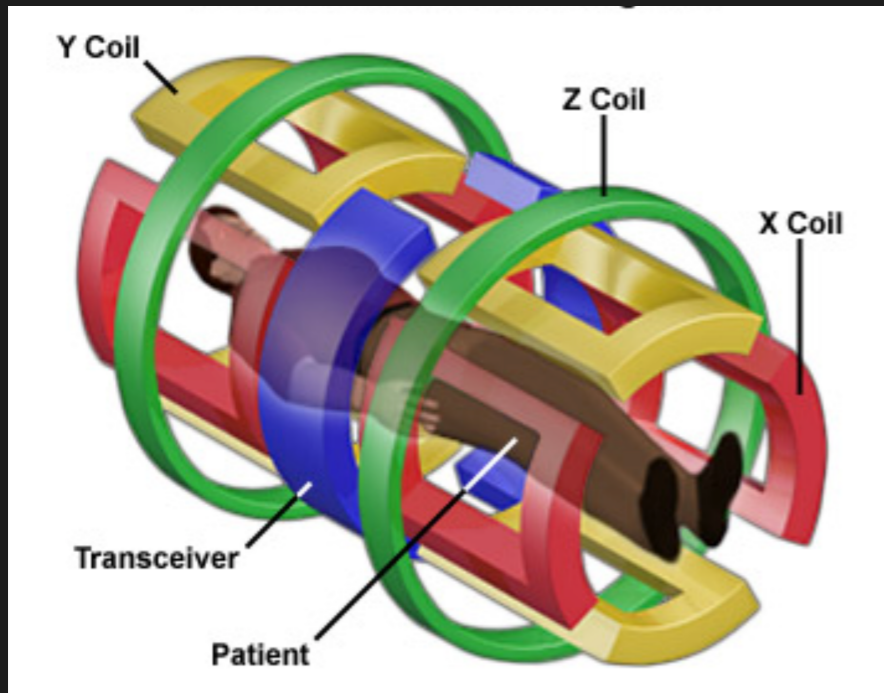

Create additional field

3 orthogonal coils

Any double oblique gradient

Use most energy

Make all the noise

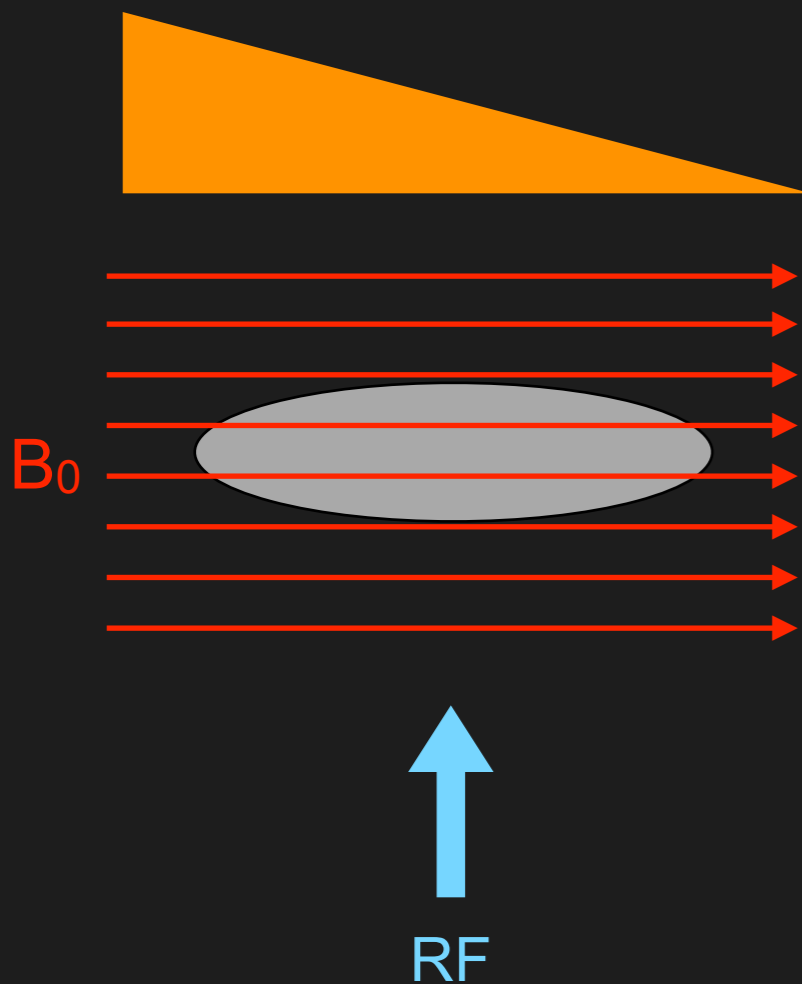

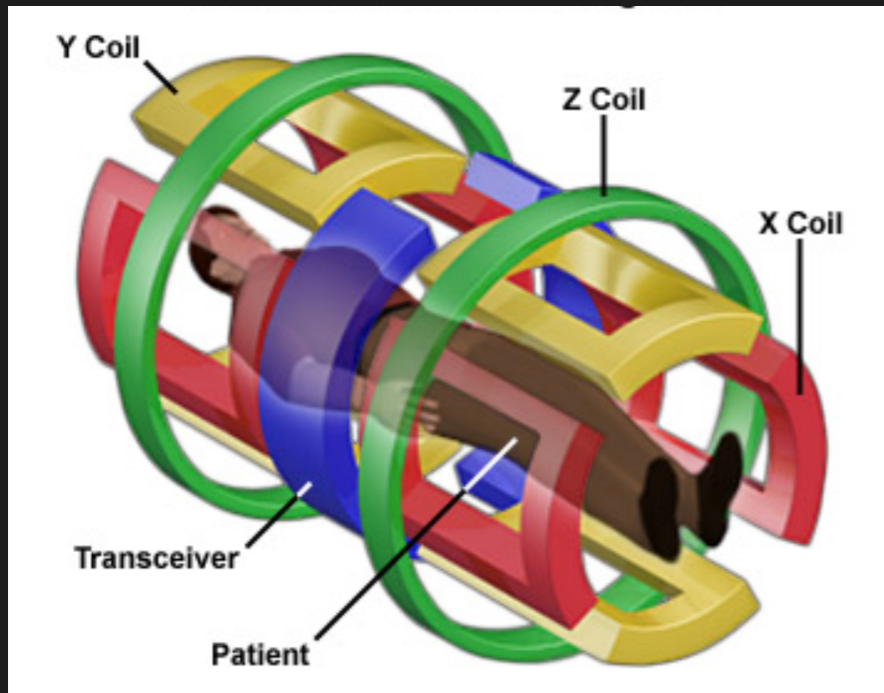

Create additional field

3 orthogonal coils

Any double oblique gradient

Use most energy

Make all the noise

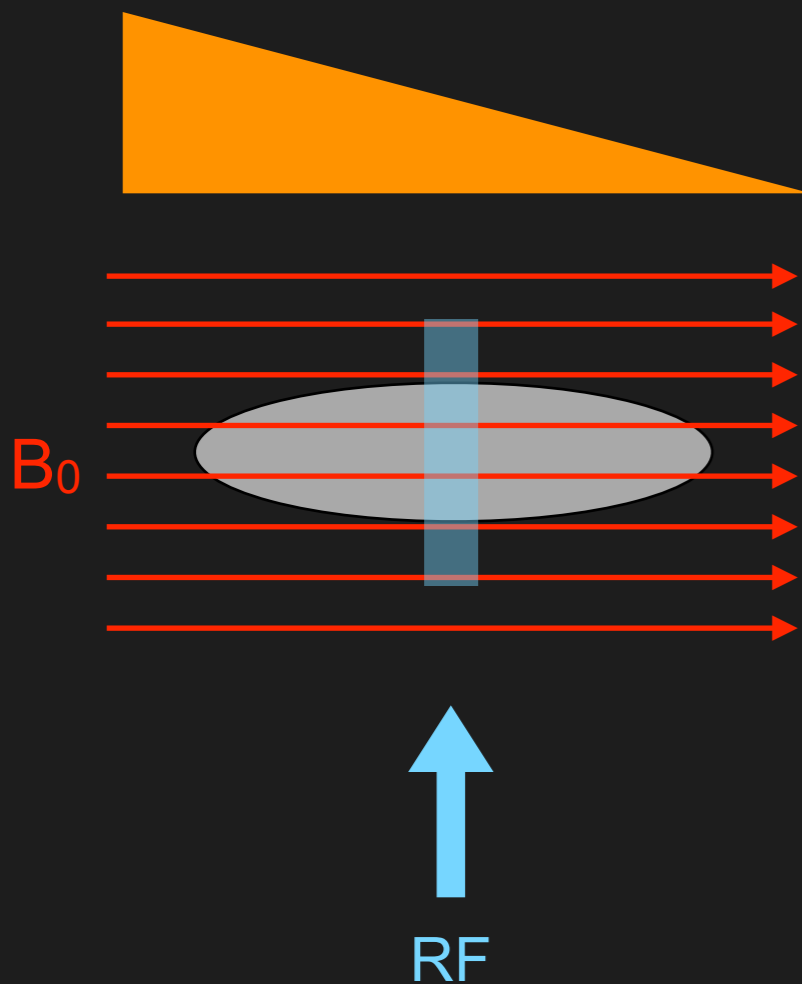



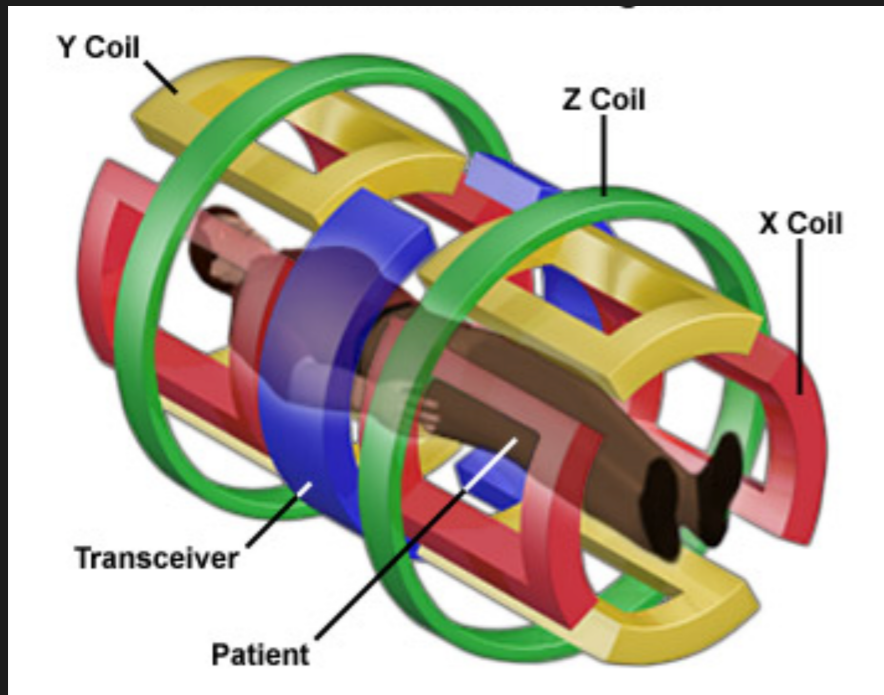

Create additional field

3 orthogonal coils

Any double oblique gradient

Use most energy

Make all the noise

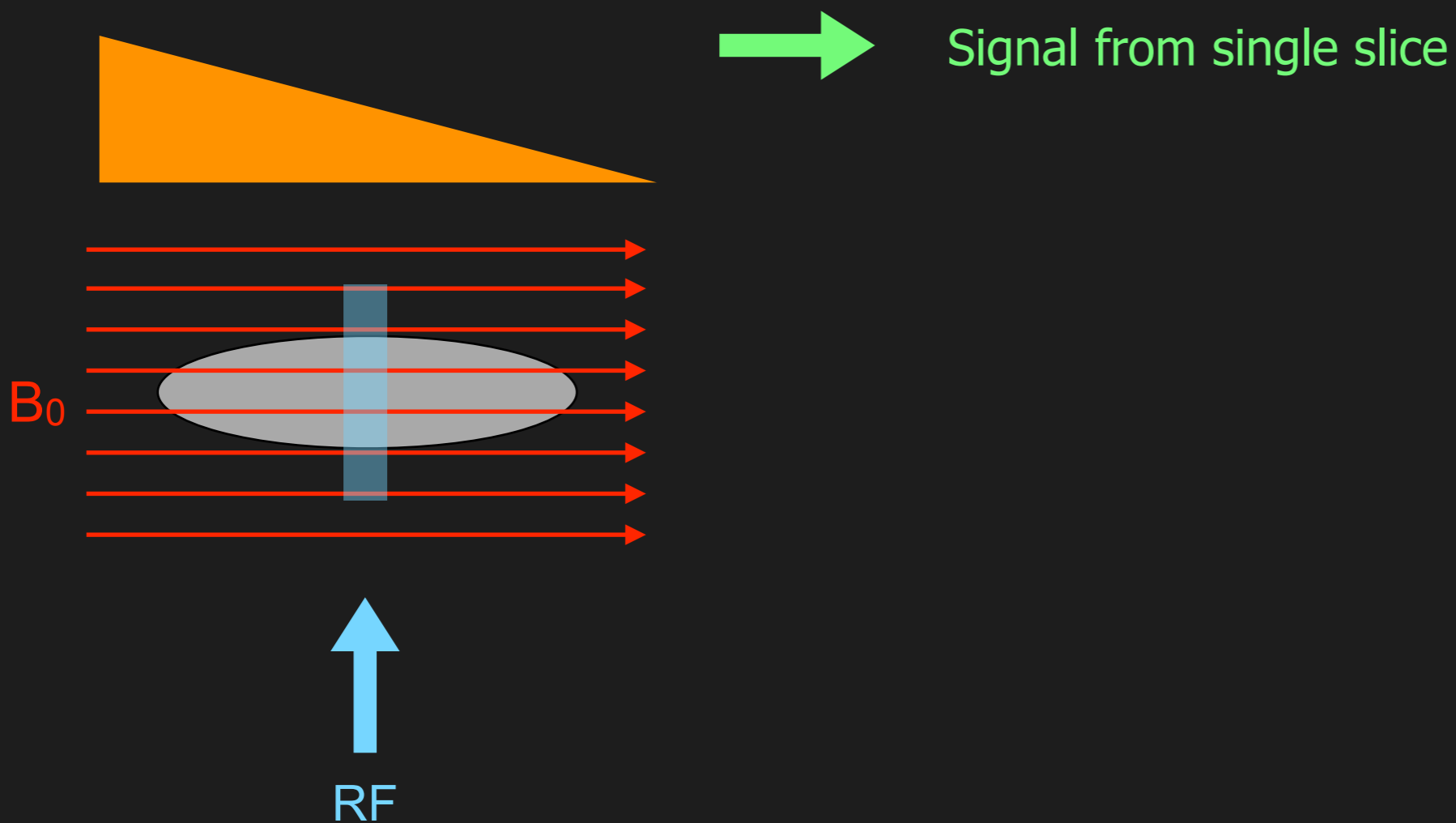

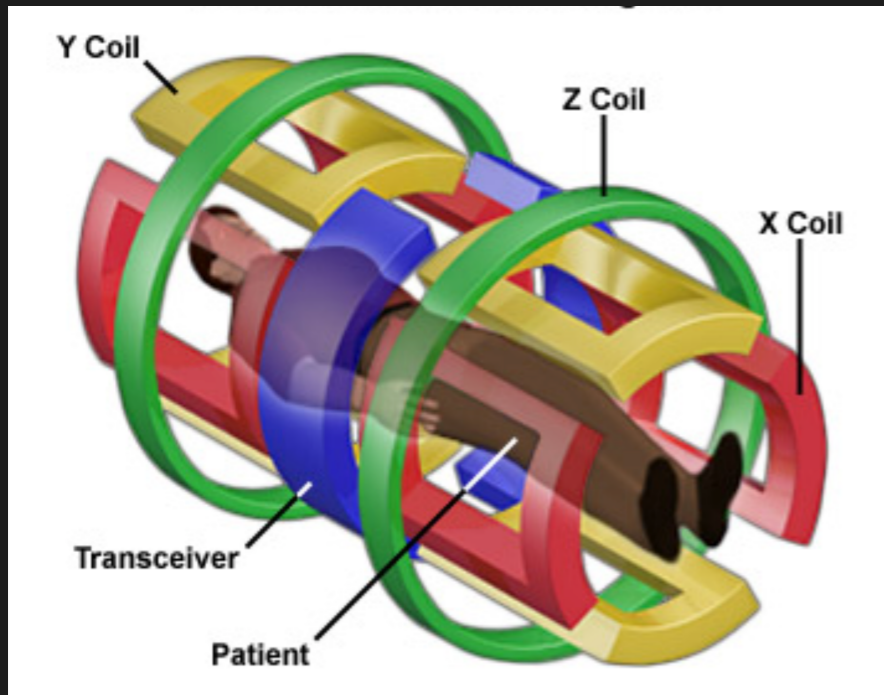

Create additional field

3 orthogonal coils

Any double oblique gradient

Use most energy

Make all the noise

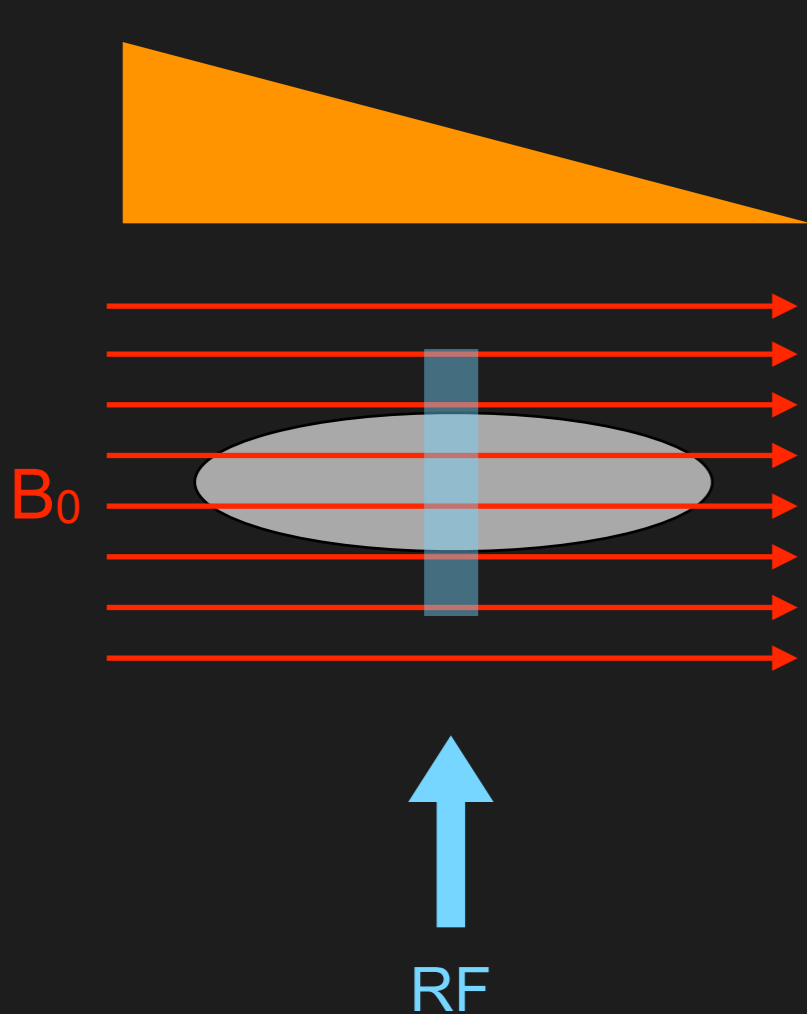

Signal from single slice

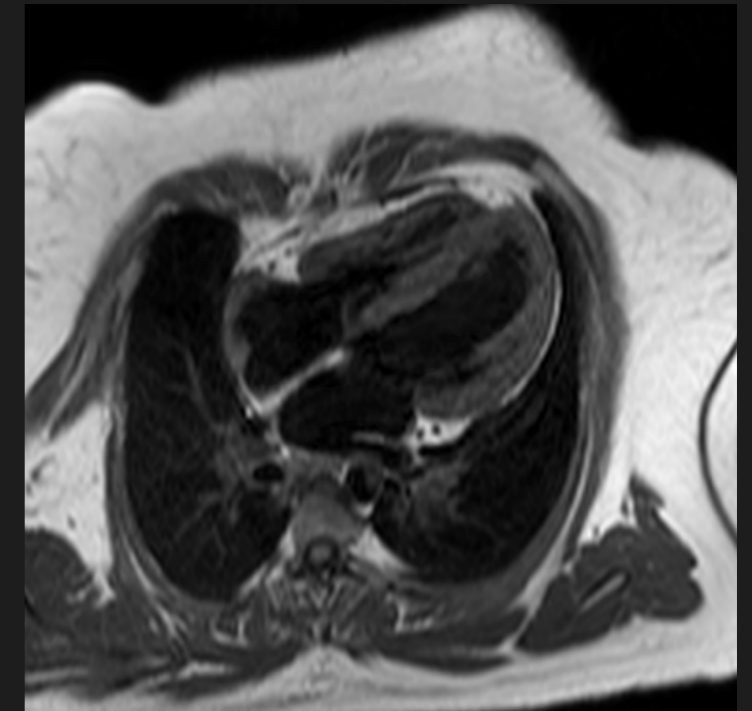

# A simplified example

| 1                         | 2                         |
|---------------------------|---------------------------|
| <b><math>S_1=3</math></b> | <b><math>S_2=5</math></b> |
| <b><math>S_3=8</math></b> | <b><math>S_4=2</math></b> |
| 3                         | 4                         |

# A simplified example

| 1       | 2       |
|---------|---------|
| $S_1=3$ | $S_2=5$ |
| $S_3=8$ | $S_4=2$ |
| 3       | 4       |

$$S_{0,0} = S_1 + S_2 + S_3 + S_4 = \mathbf{18}$$

# A simplified example



$$S_{0,0} = S_1 + S_2 + S_3 + S_4 = \mathbf{18}$$

# A simplified example

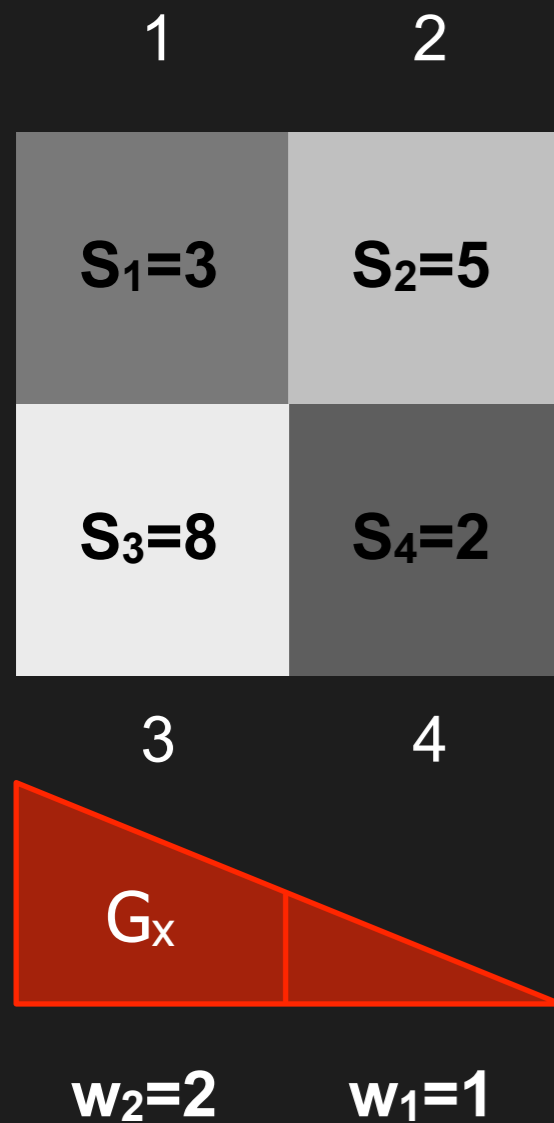

$$S_{0,0} = S_1 + S_2 + S_3 + S_4 = \mathbf{18}$$

$$S_{Gx,0} = w_2 S_1 + w_1 S_2 + w_2 S_3 + w_1 S_4 = \mathbf{29}$$

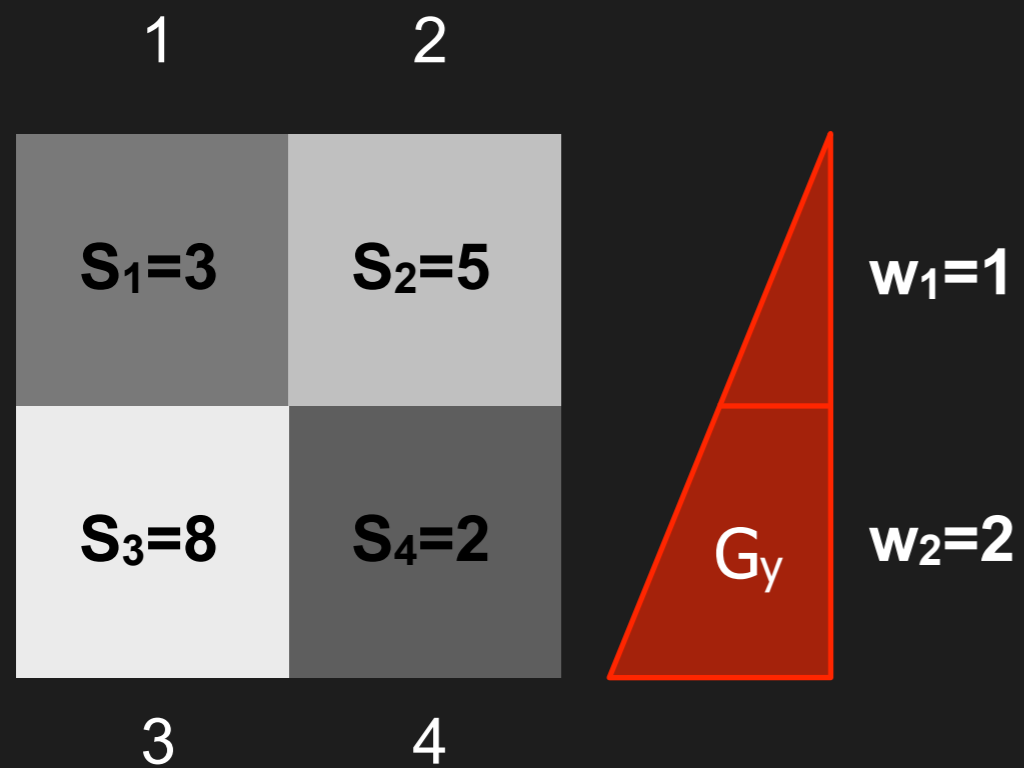

$$S_{0,0} = S_1 + S_2 + S_3 + S_4 = \mathbf{18}$$

$$S_{Gx,0} = w_2 S_1 + w_1 S_2 + w_2 S_3 + w_1 S_4 = \mathbf{29}$$

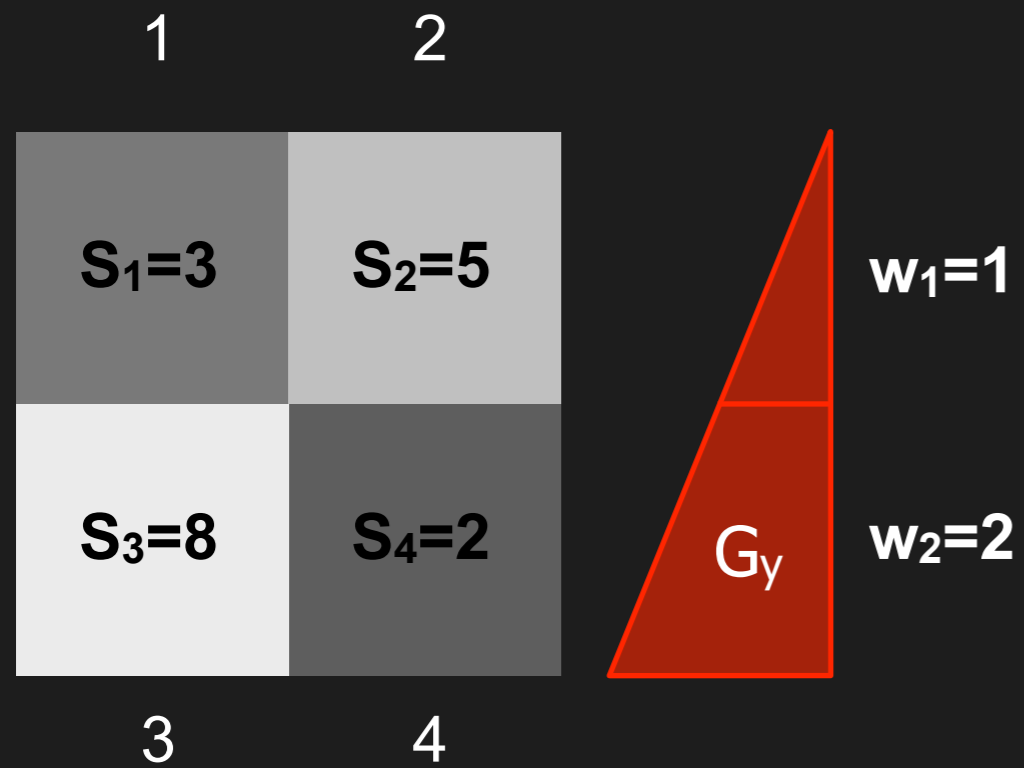

$$S_{0,0} = S_1 + S_2 + S_3 + S_4 = \mathbf{18}$$

$$S_{G_x,0} = w_2 S_1 + w_1 S_2 + w_2 S_3 + w_1 S_4 = \mathbf{29}$$

$$S_{0,G_y} = w_1 S_1 + w_1 S_2 + w_2 S_3 + w_2 S_4 = \mathbf{28}$$



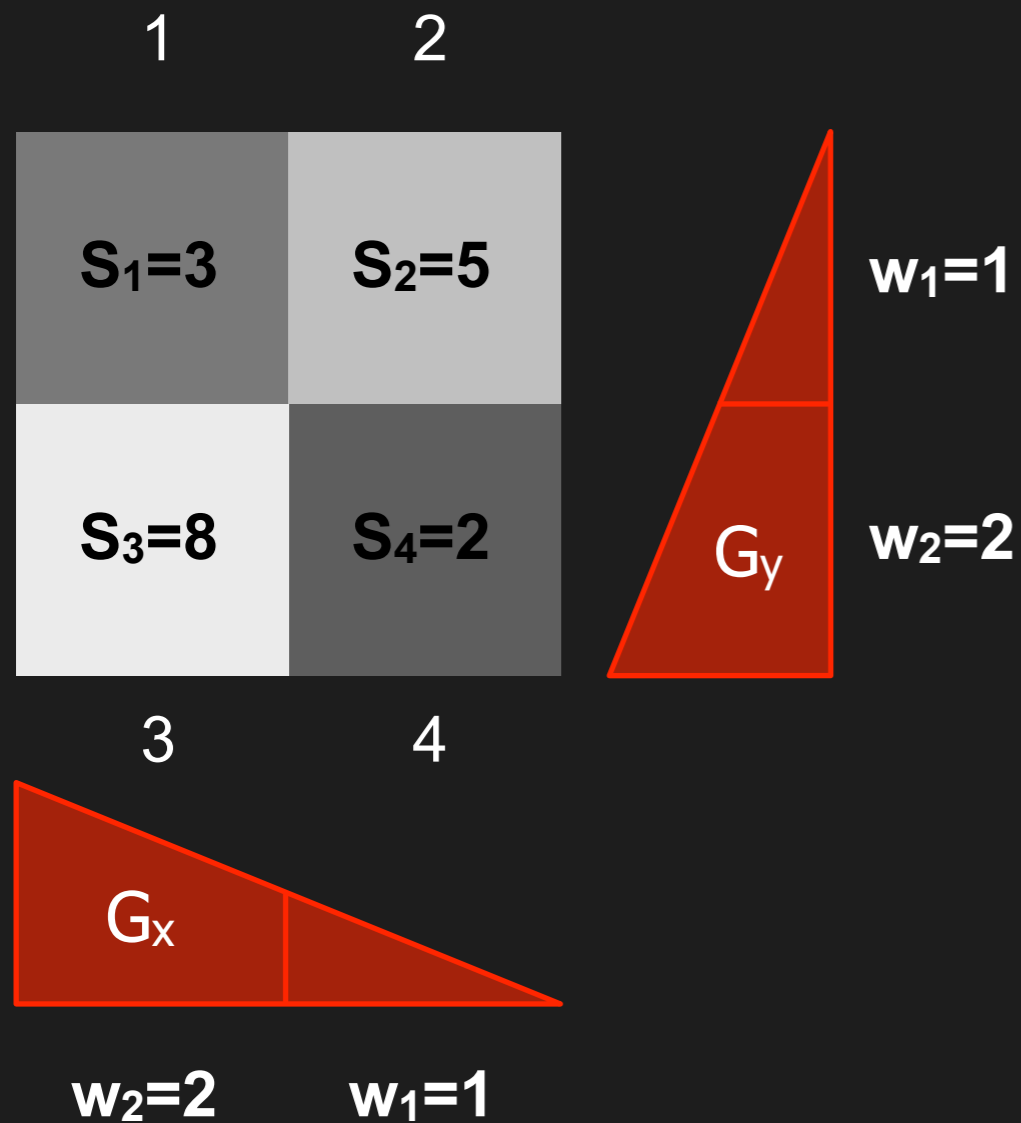

$$S_{0,0} = S_1 + S_2 + S_3 + S_4 = \mathbf{18}$$

$$S_{G_x,0} = w_2 S_1 + w_1 S_2 + w_2 S_3 + w_1 S_4 = \mathbf{29}$$

$$S_{0,G_y} = w_1 S_1 + w_1 S_2 + w_2 S_3 + w_2 S_4 = \mathbf{28}$$

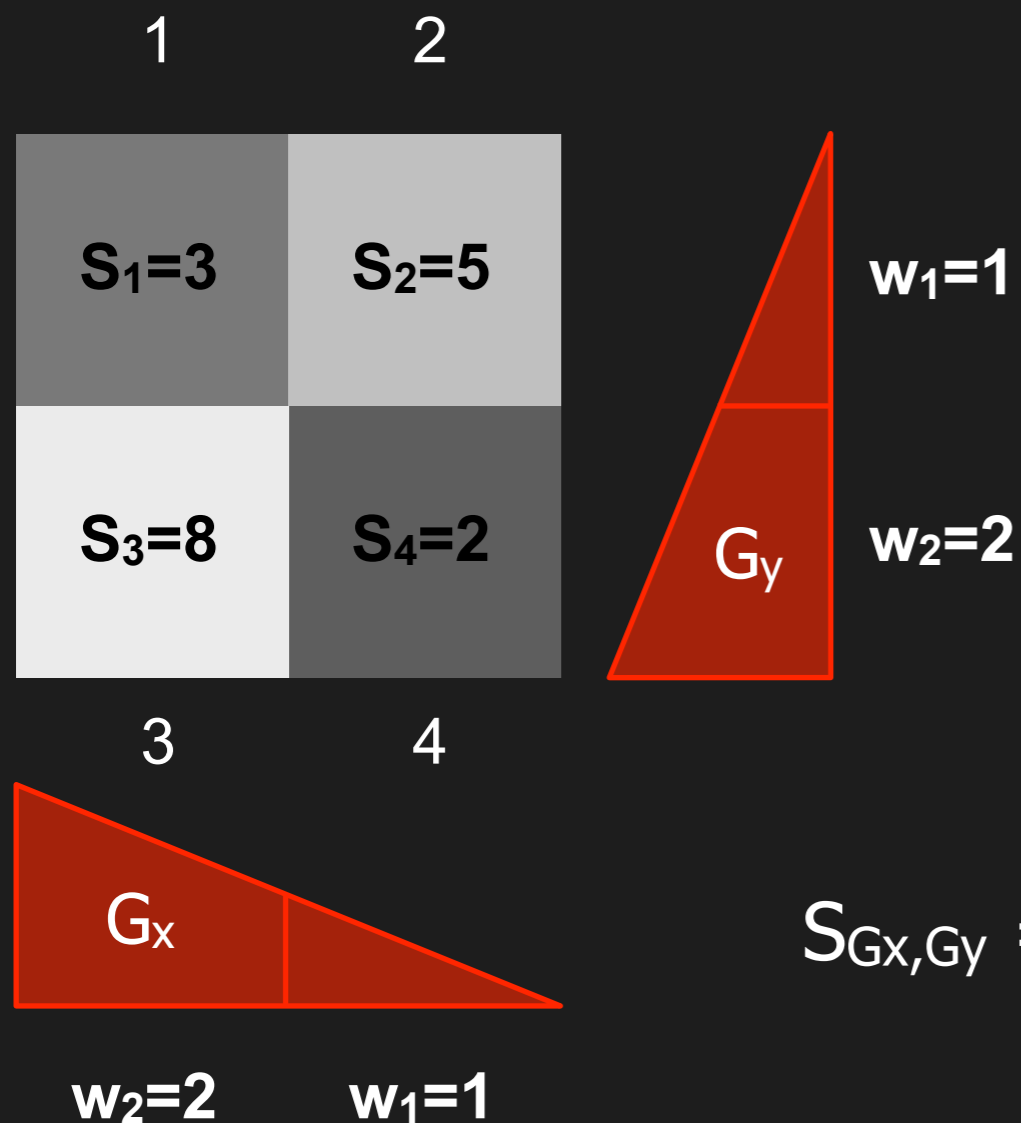

$$S_{0,0} = S_1 + S_2 + S_3 + S_4 = \mathbf{18}$$

$$S_{G_x,0} = w_2 S_1 + w_1 S_2 + w_2 S_3 + w_1 S_4 = \mathbf{29}$$

$$S_{0,G_y} = w_1 S_1 + w_1 S_2 + w_2 S_3 + w_2 S_4 = \mathbf{28}$$

$$S_{G_x,G_y} = w_1 w_2 S_1 + w_1 w_1 S_2 + w_2 w_2 S_3 + w_2 w_1 S_4 = \mathbf{47}$$

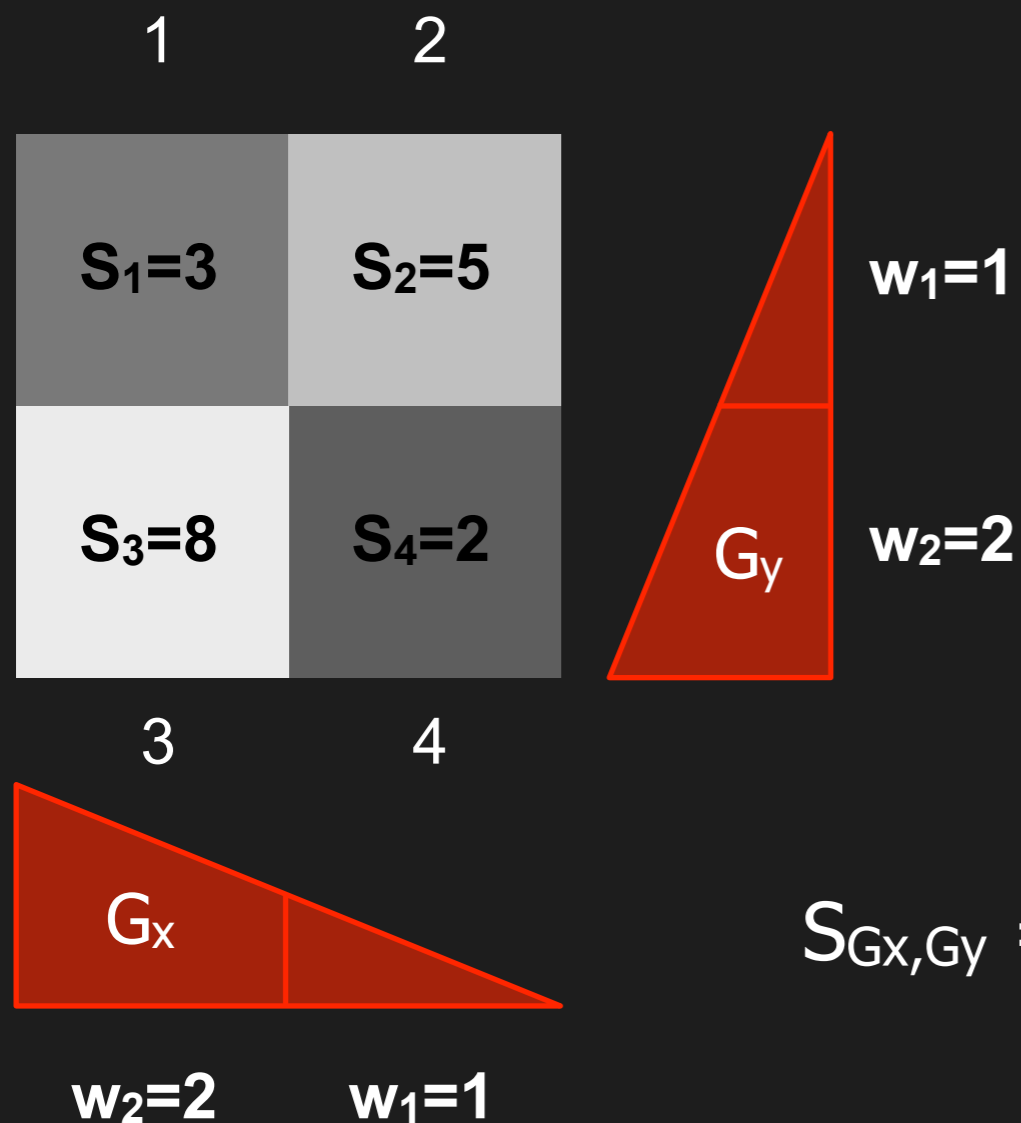

$$S_{0,0} = S_1 + S_2 + S_3 + S_4 = \mathbf{18}$$

$$S_{G_x,0} = w_2 S_1 + w_1 S_2 + w_2 S_3 + w_1 S_4 = \mathbf{29}$$

$$S_{0,G_y} = w_1 S_1 + w_1 S_2 + w_2 S_3 + w_2 S_4 = \mathbf{28}$$

$$S_{G_x,G_y} = w_1 w_2 S_1 + w_1 w_1 S_2 + w_2 w_2 S_3 + w_2 w_1 S_4 = \mathbf{47}$$

Solving these 4 linear equations allows determination of signal location and strength

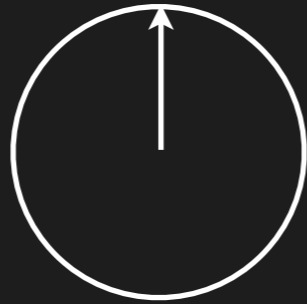
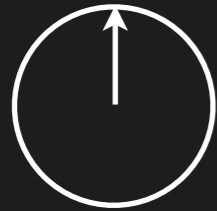

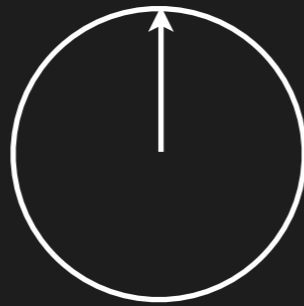
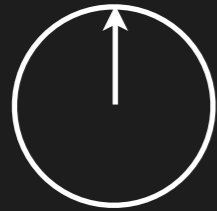

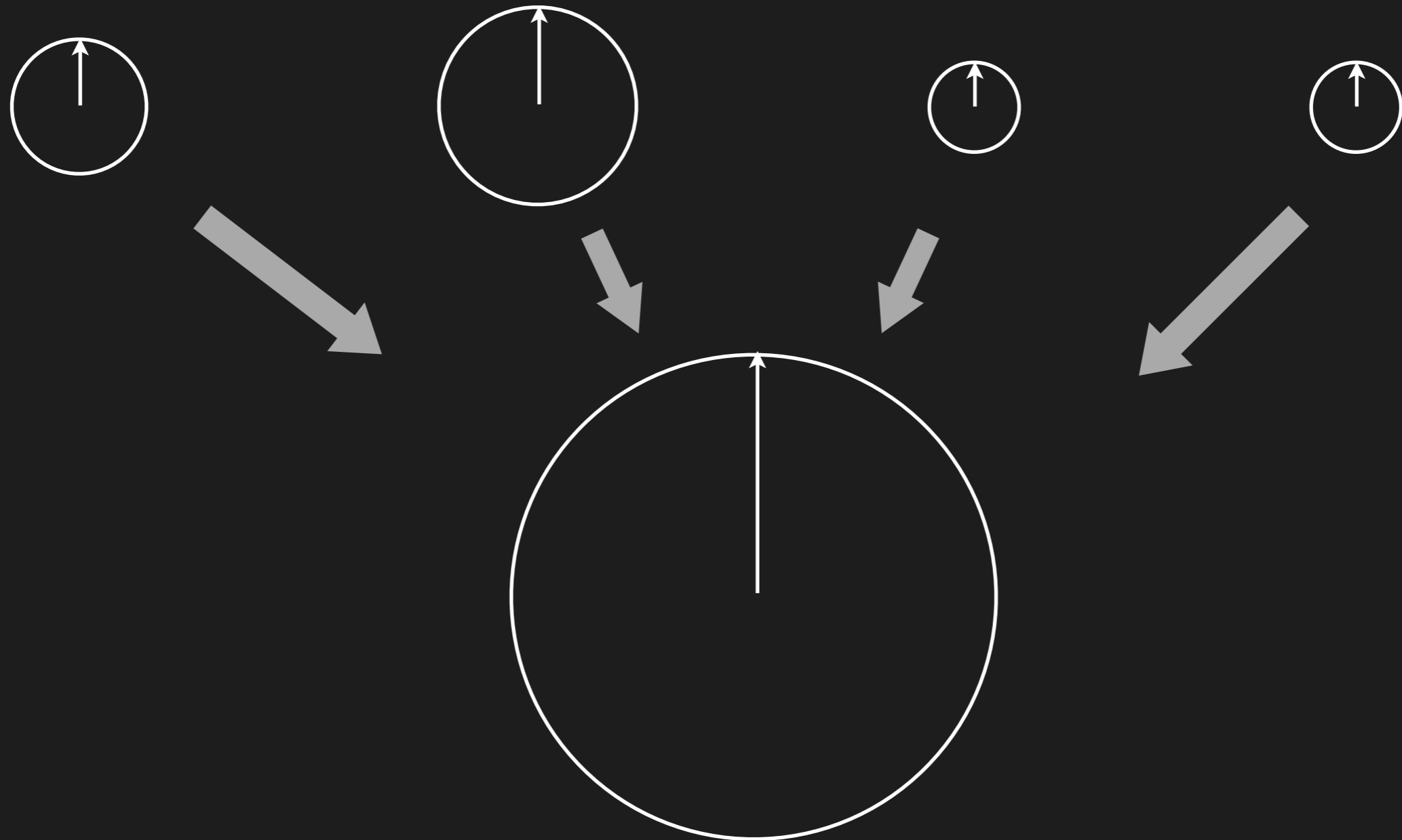

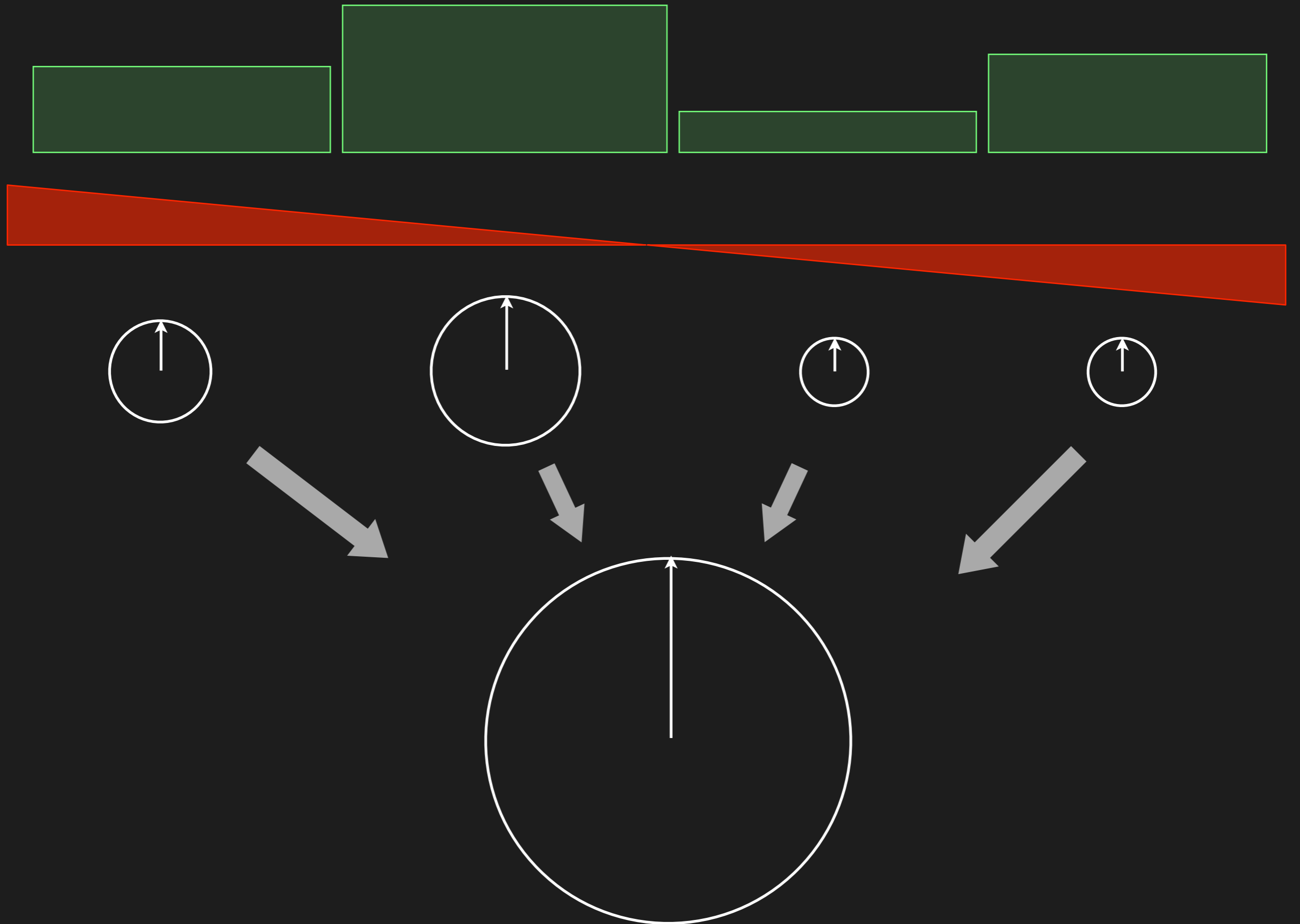

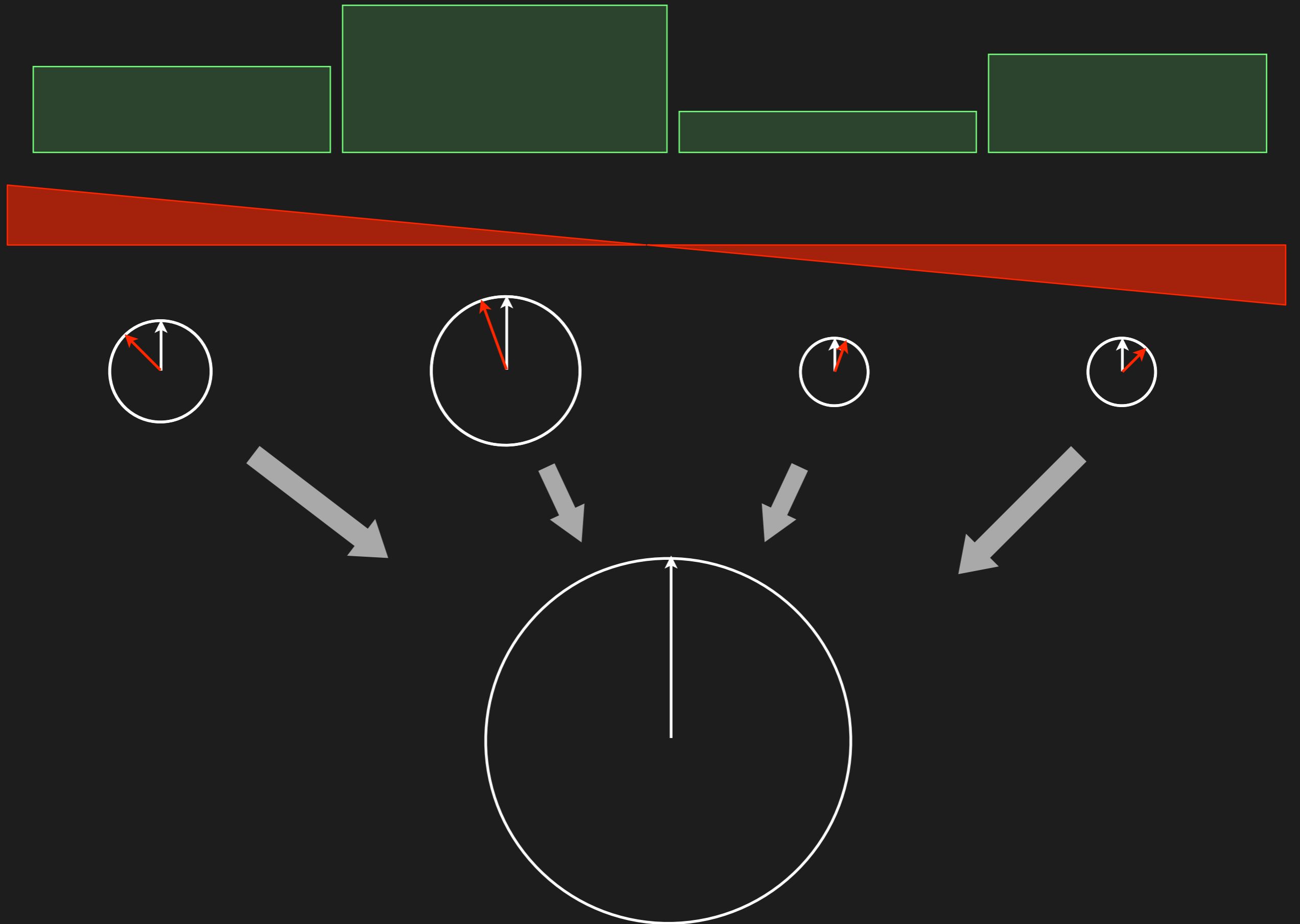



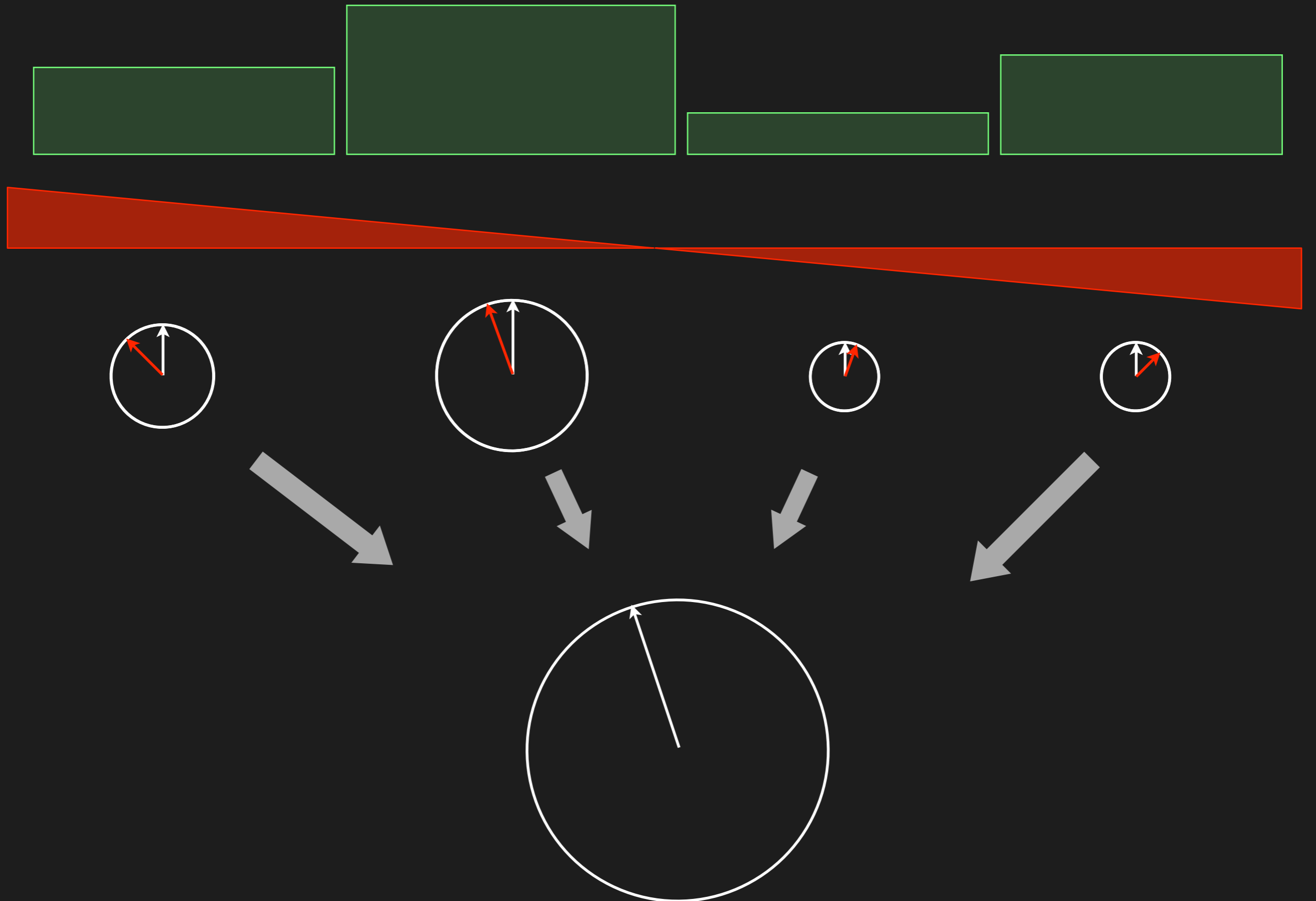

RF -----

Slice -----

Phase -----

Freq -----

# k-space filling



# k-space filling



# k-space filling



# k-space filling

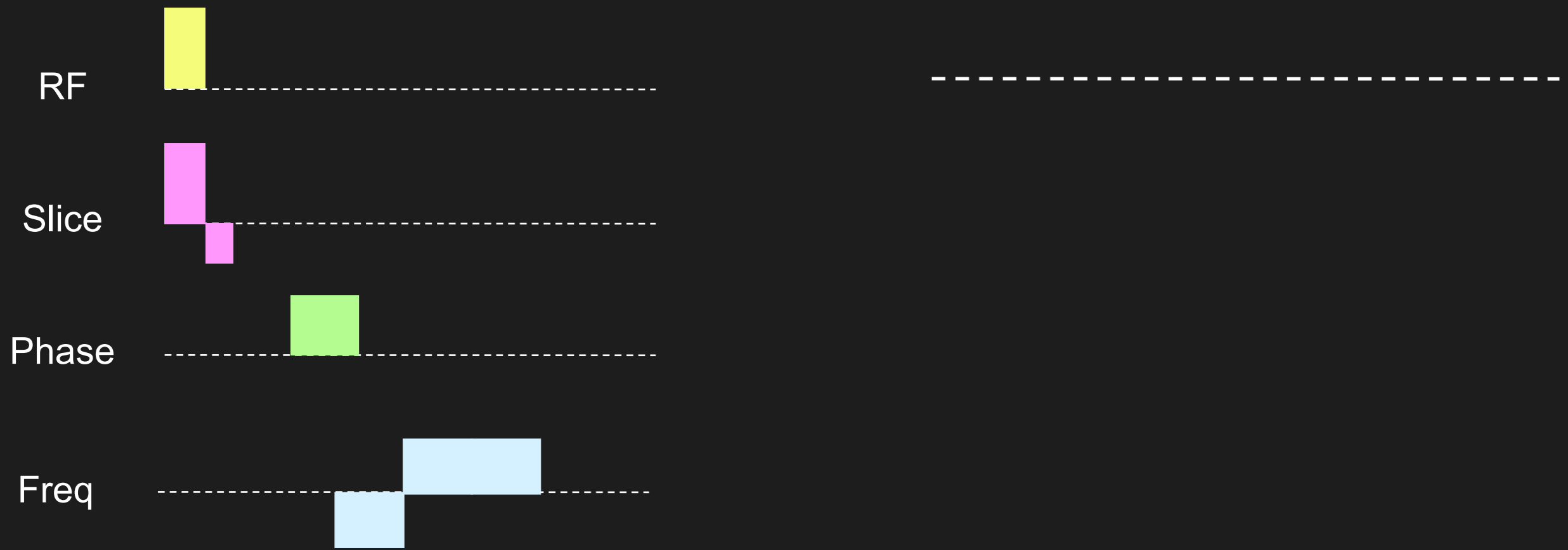

# k-space filling

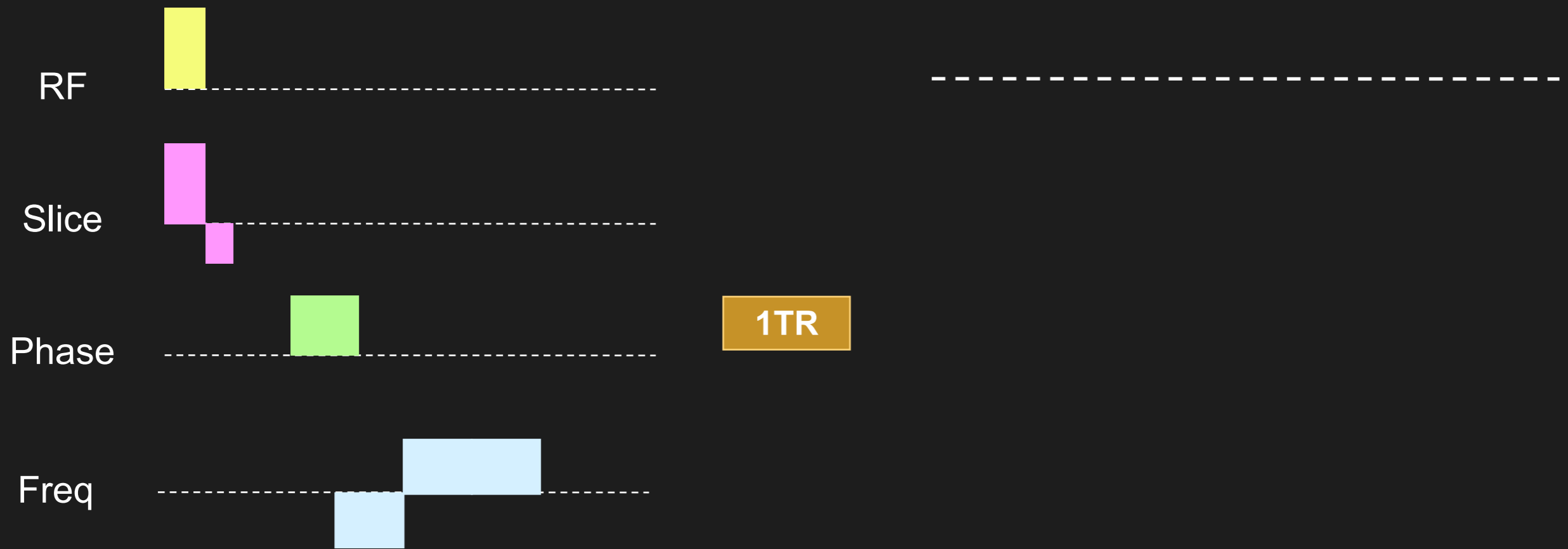

# k-space filling

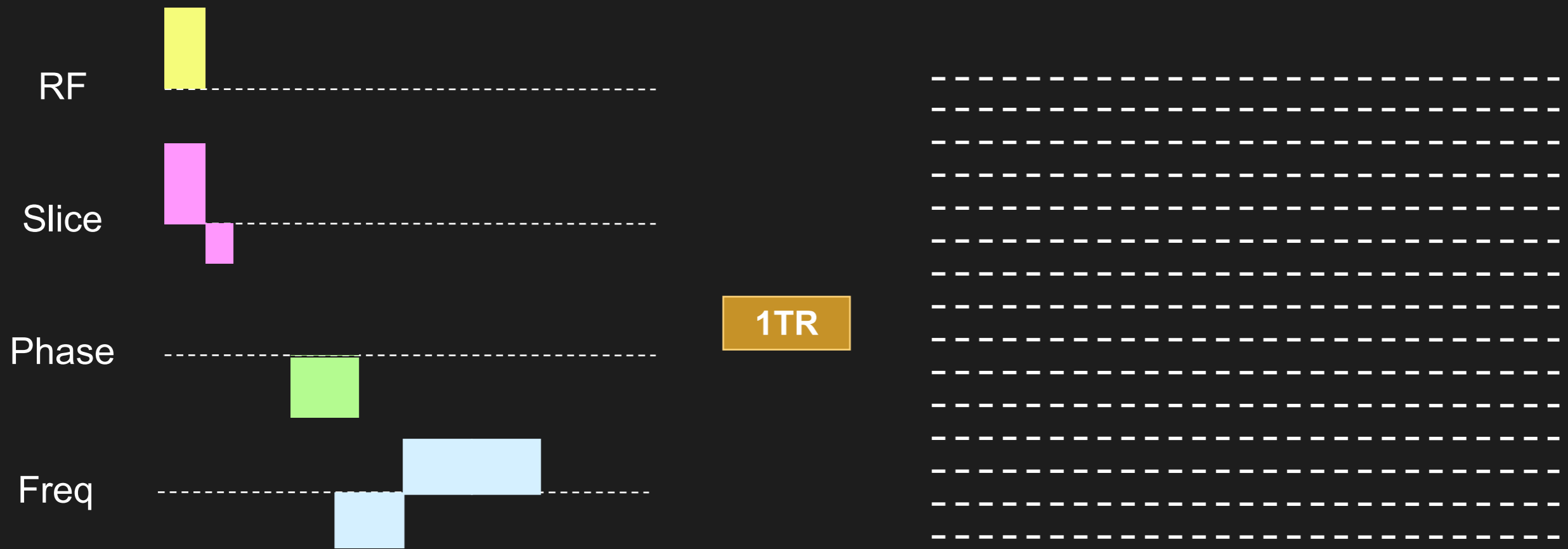



# k-space filling

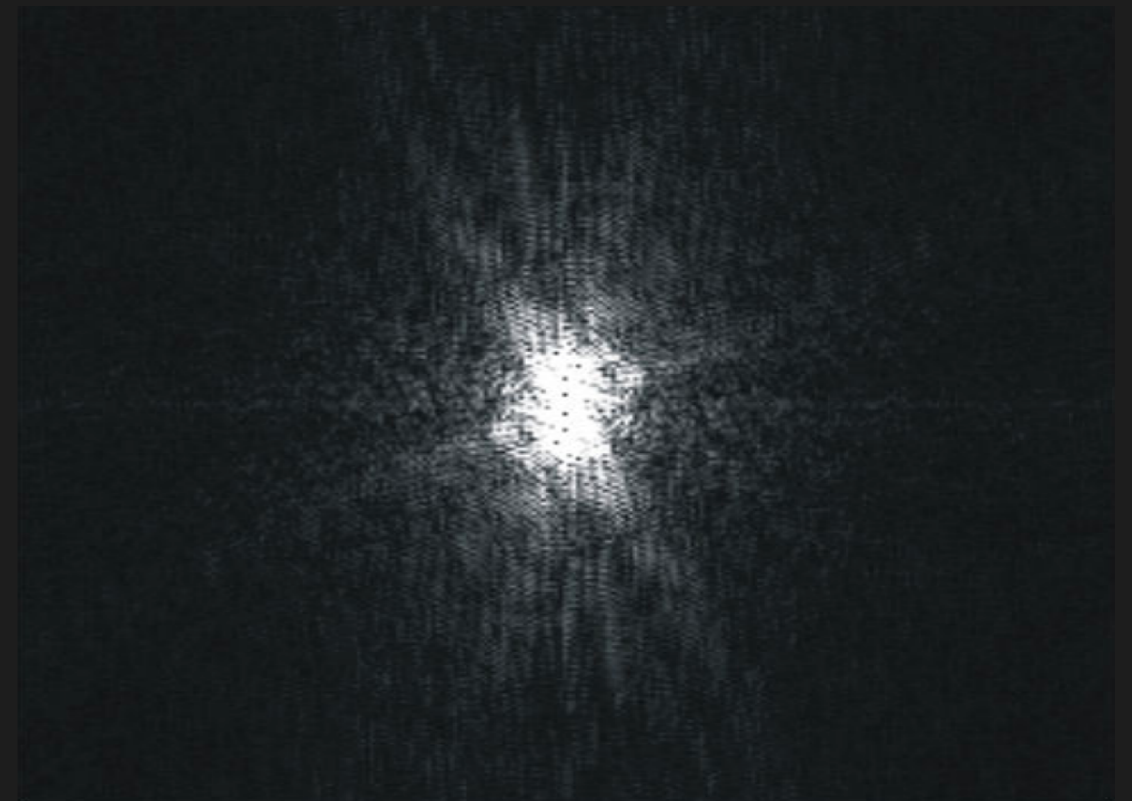
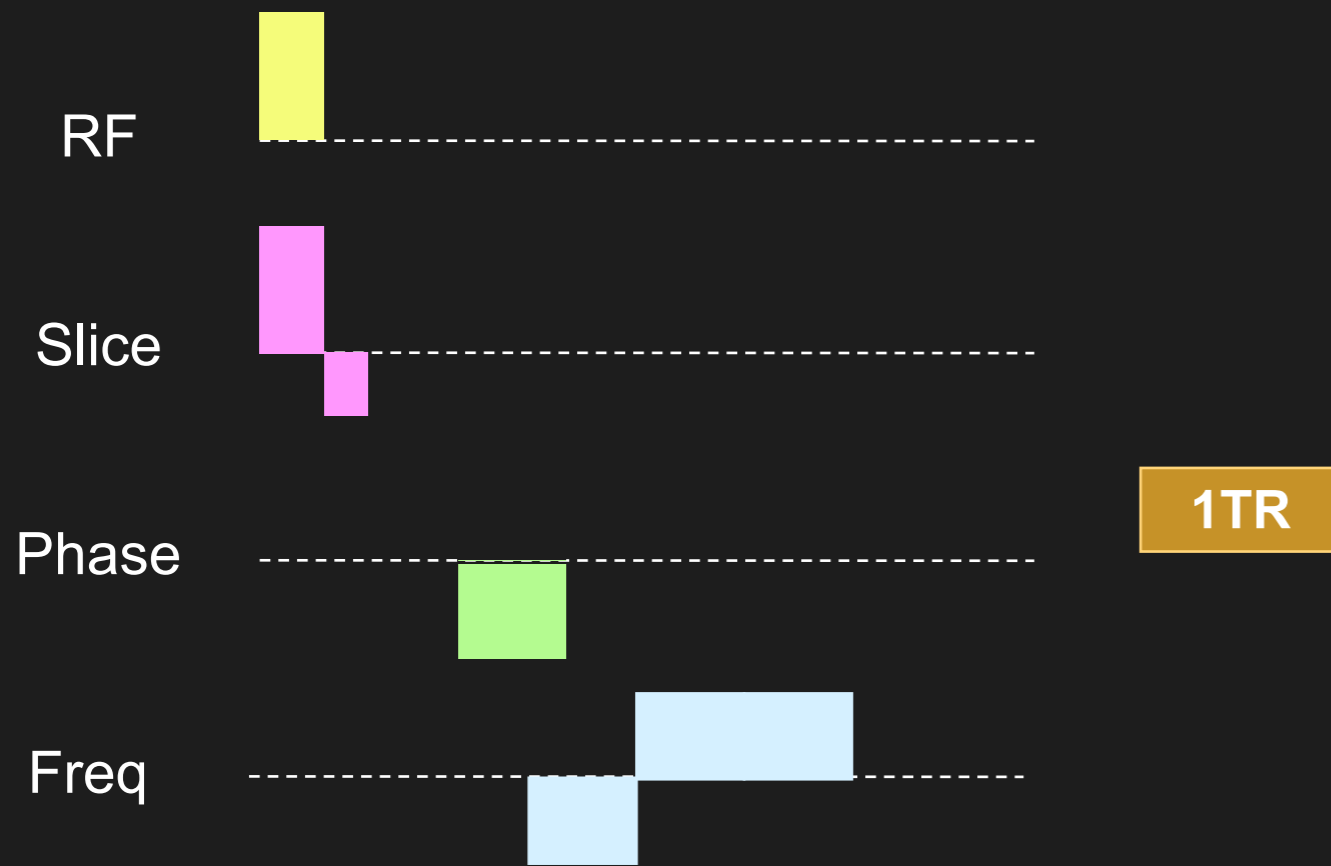

# k-space filling

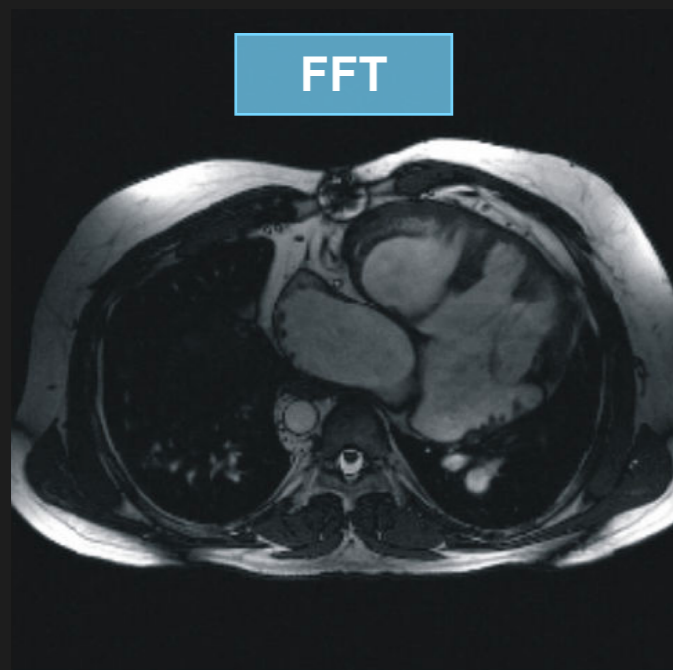
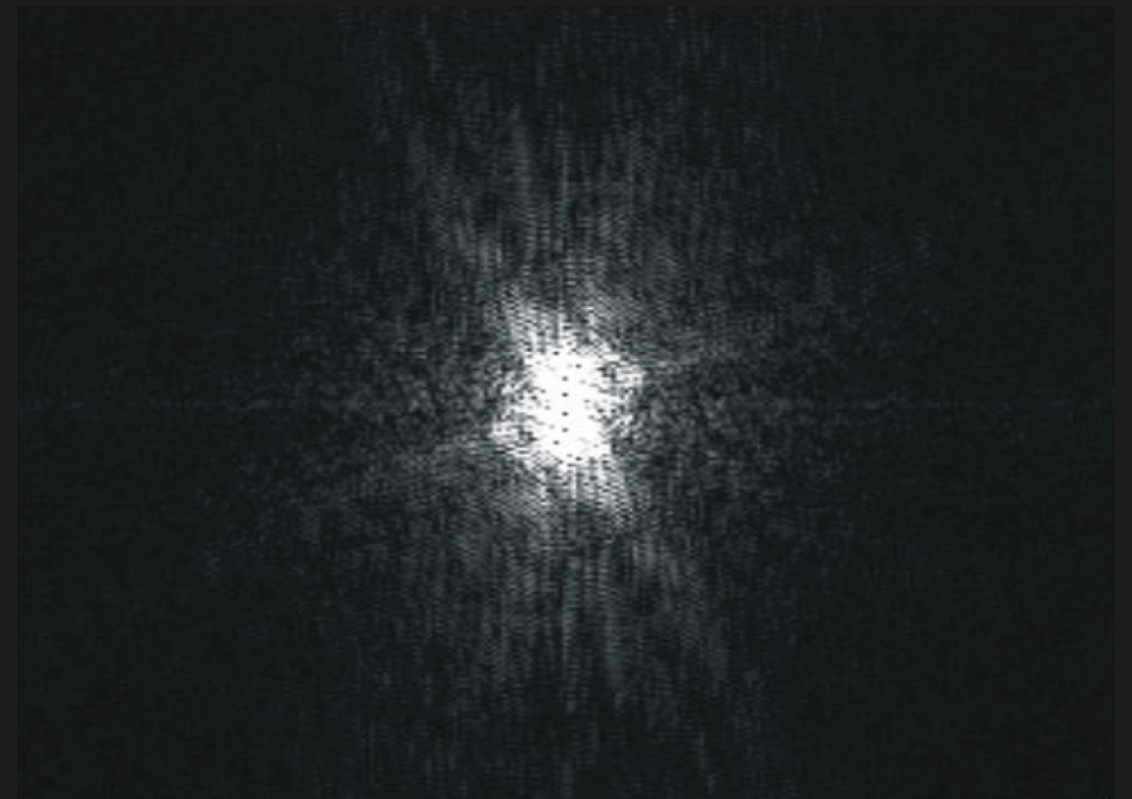
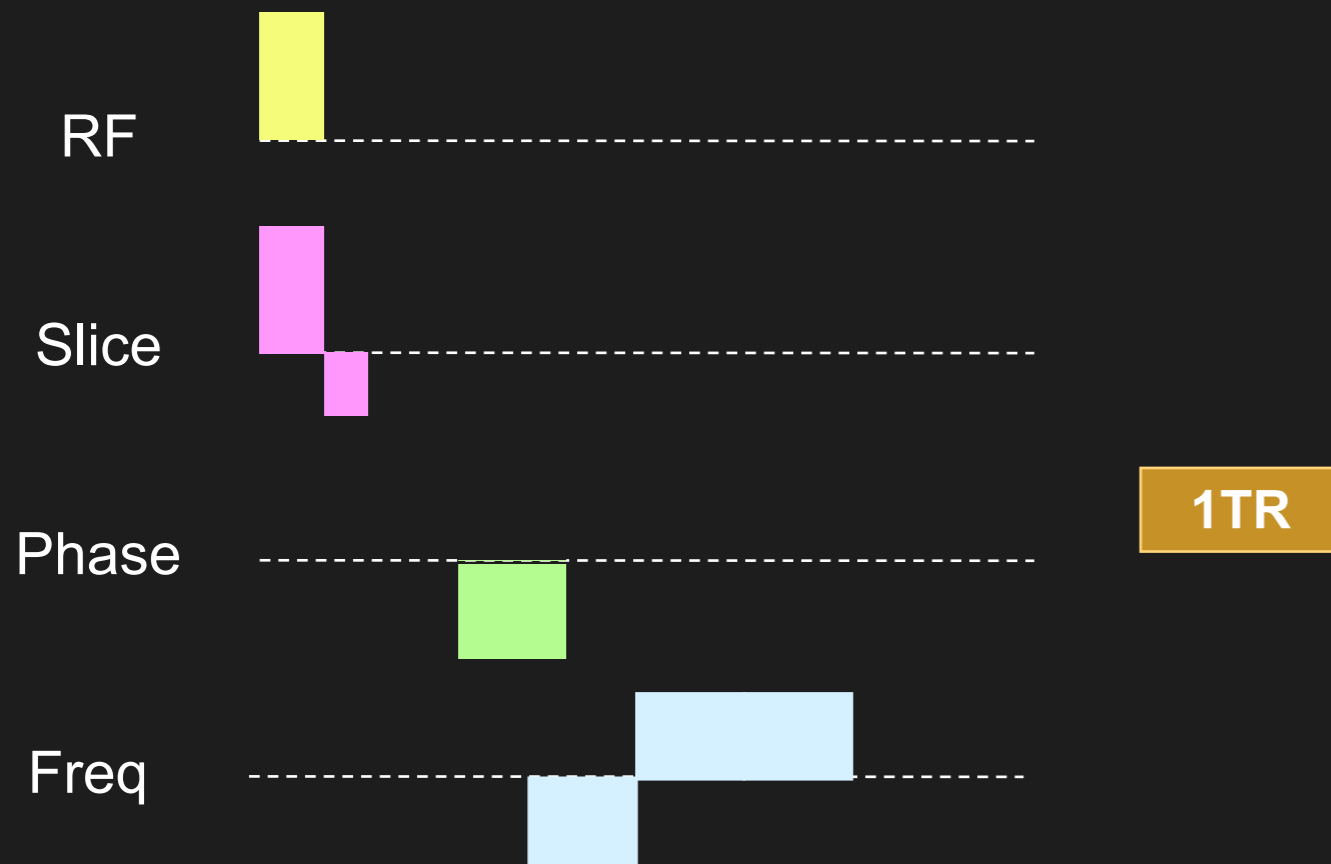

**Full image**

# k-space filling

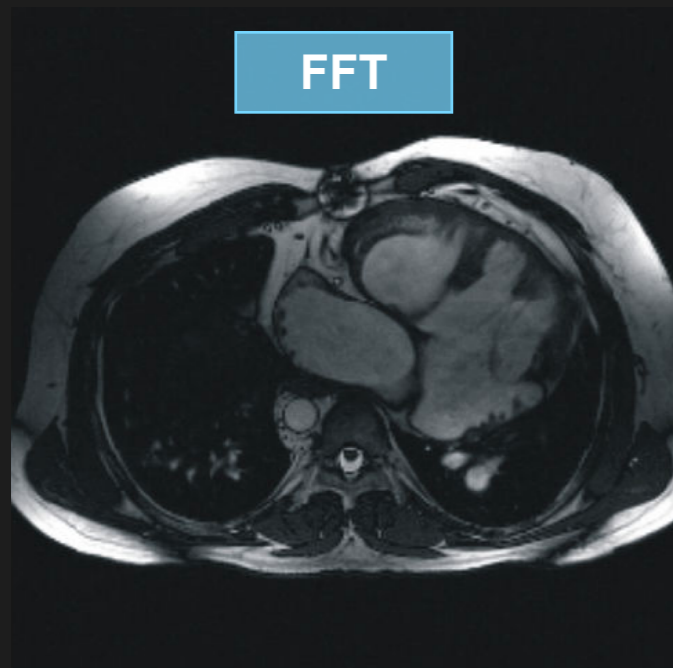
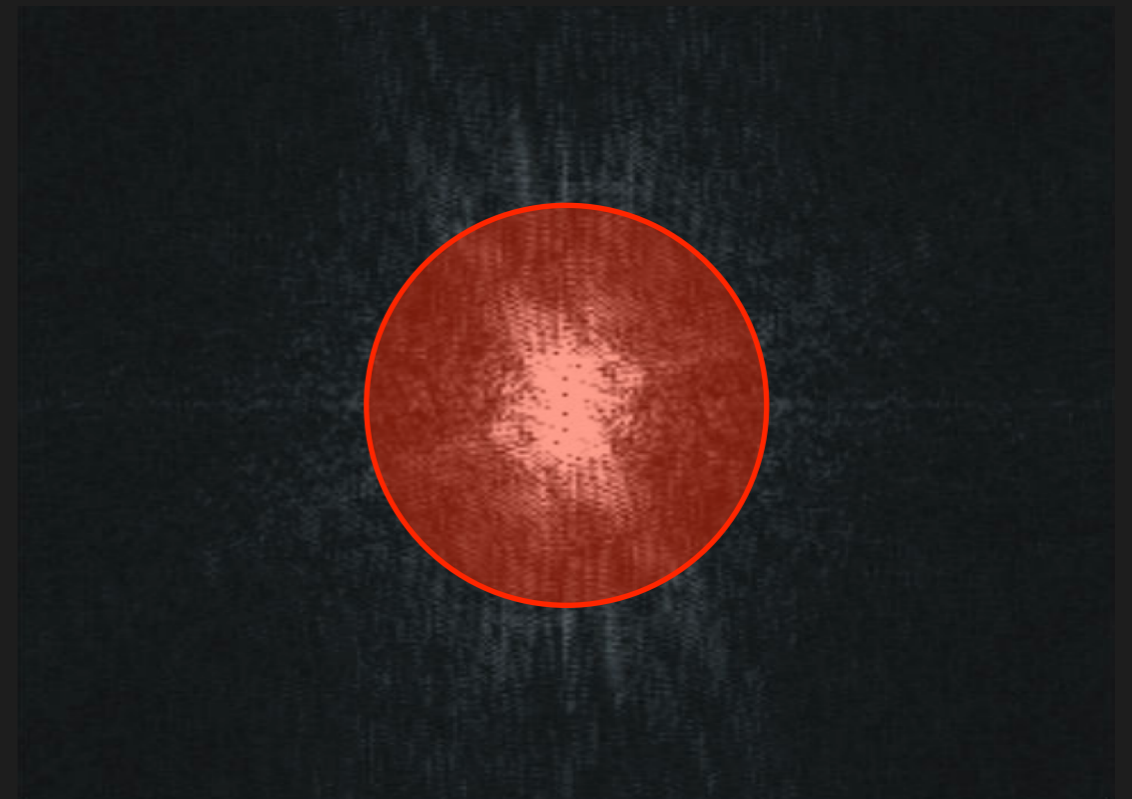
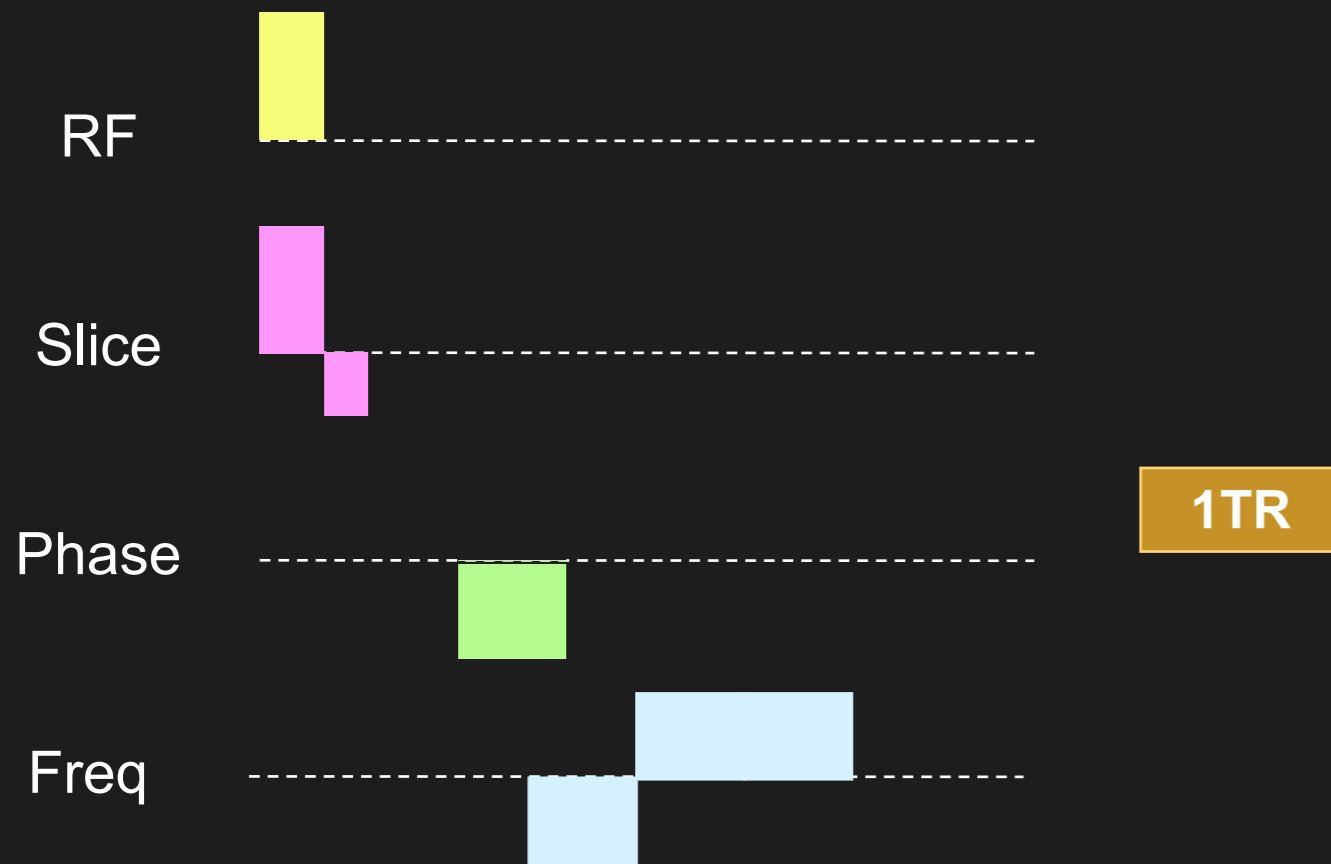

Full image

# k-space filling

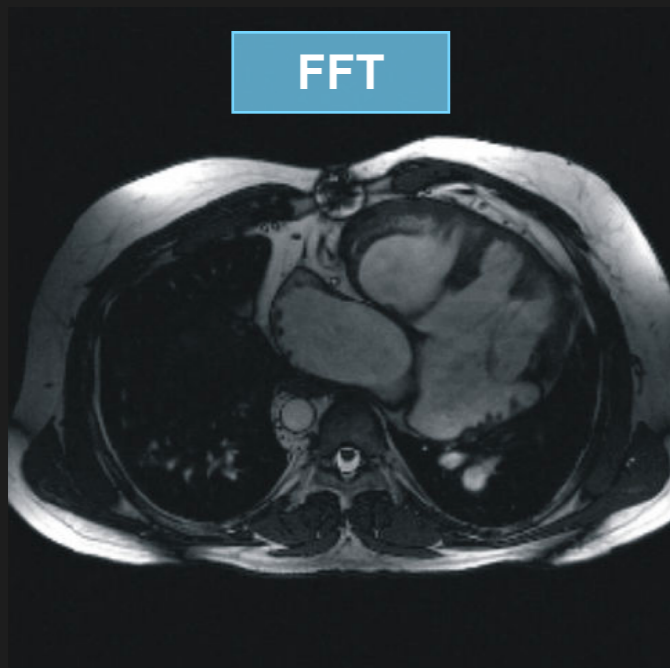
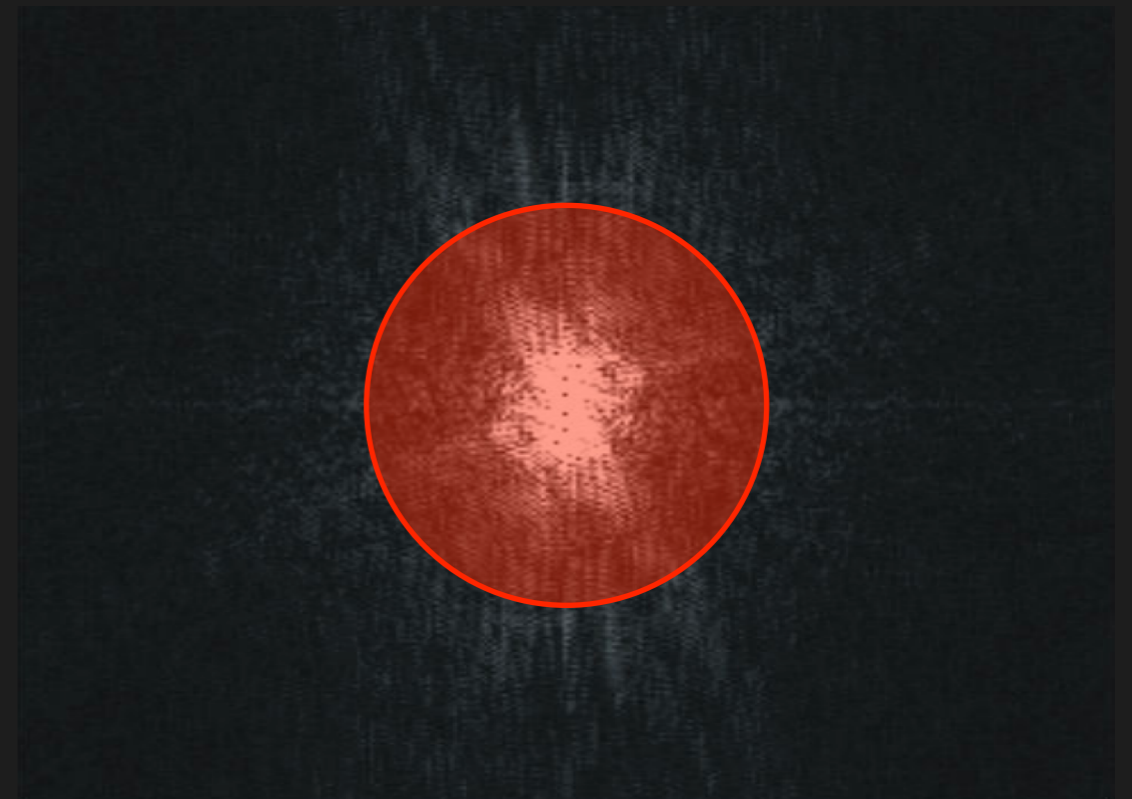
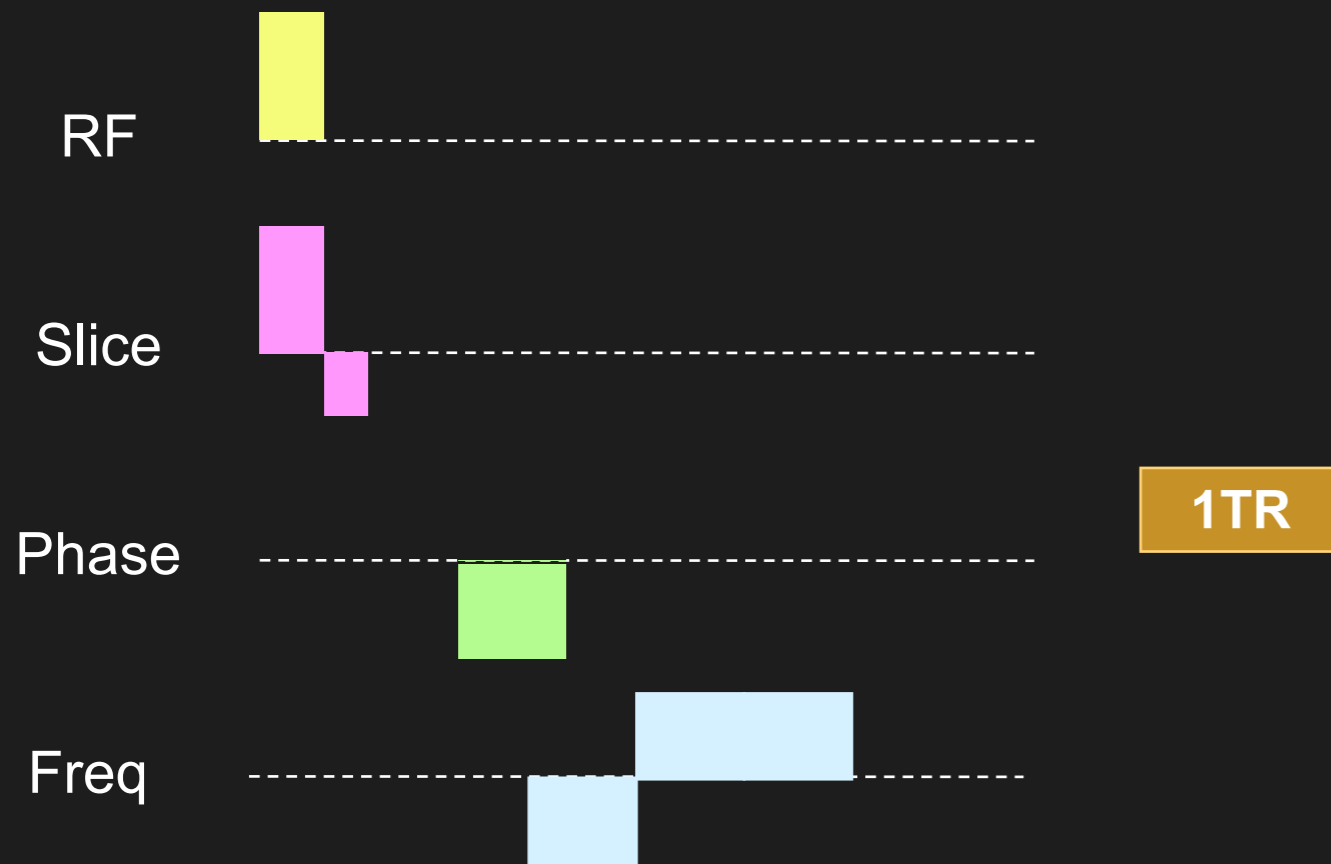

Full image

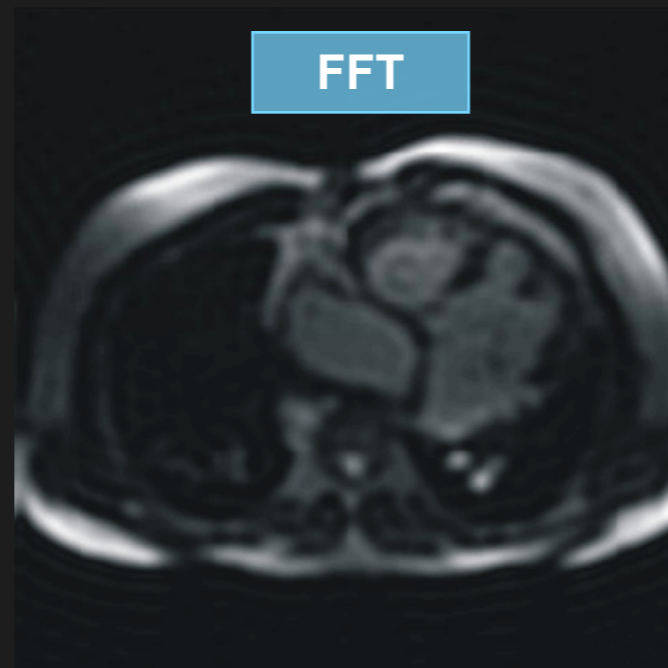

Low resolution - contrast

# k-space filling

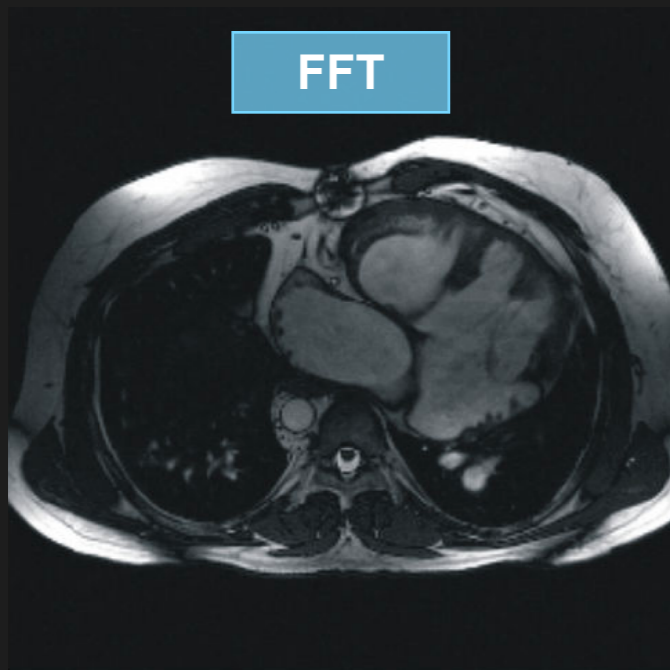
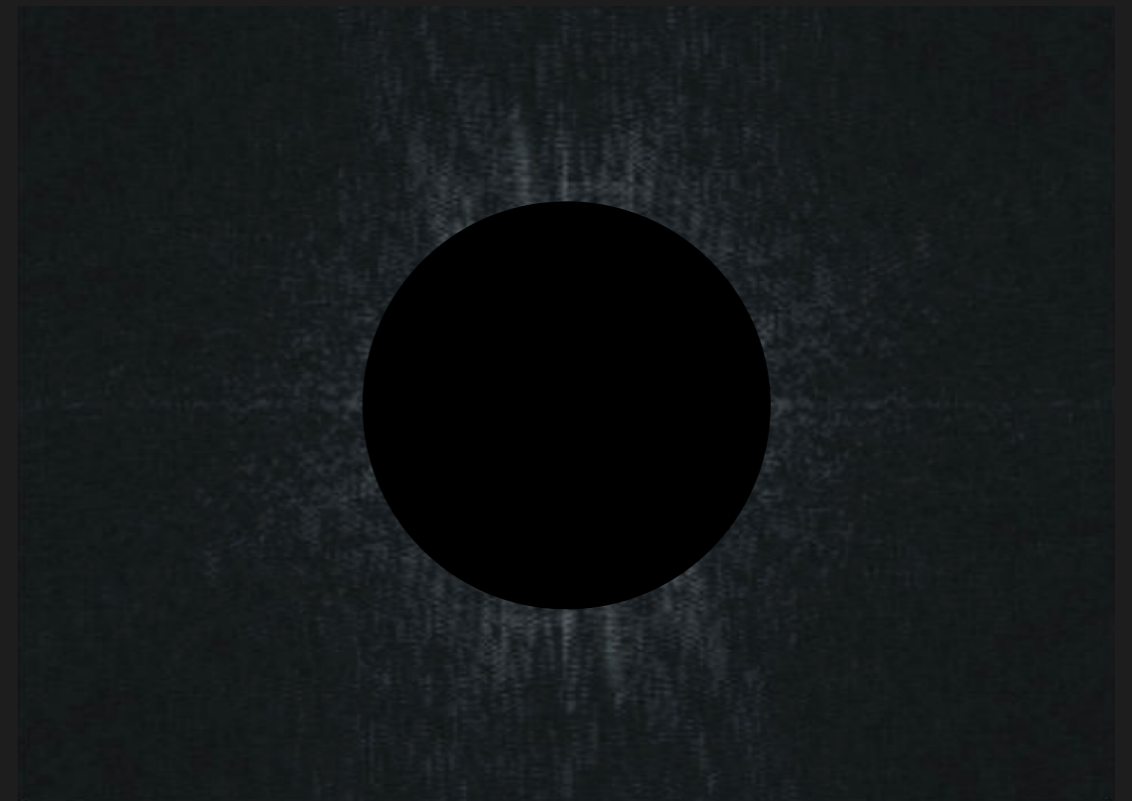
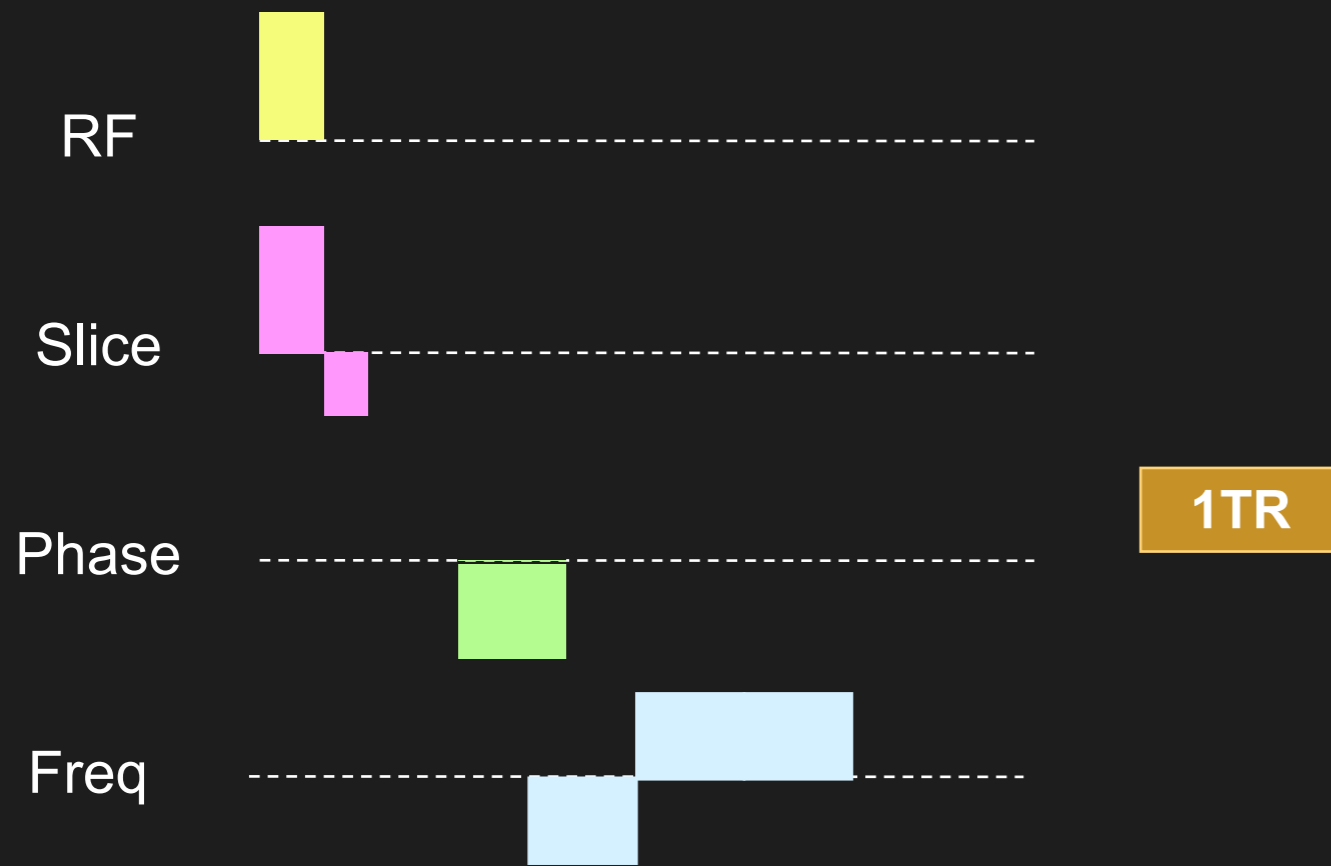

Full image

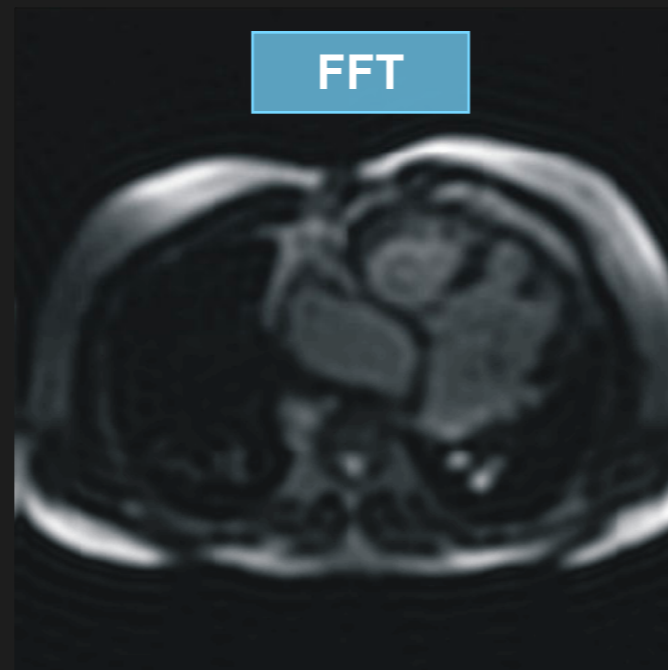

Low resolution - contrast

# k-space filling

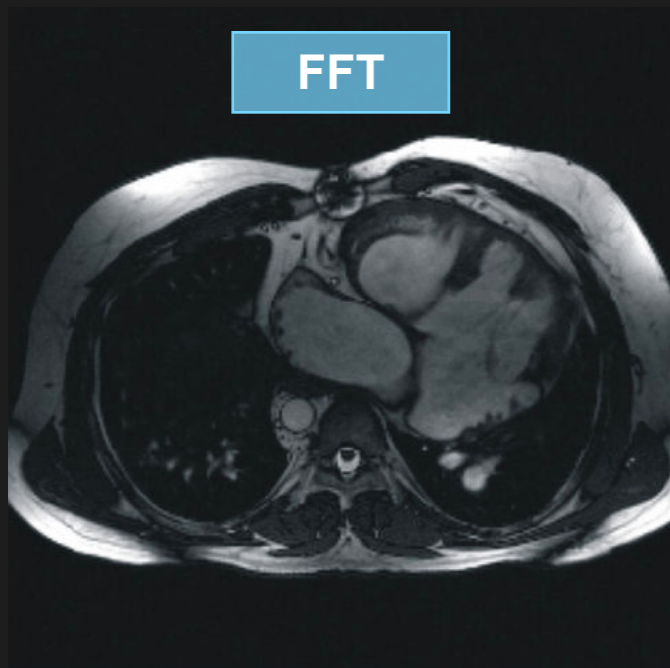
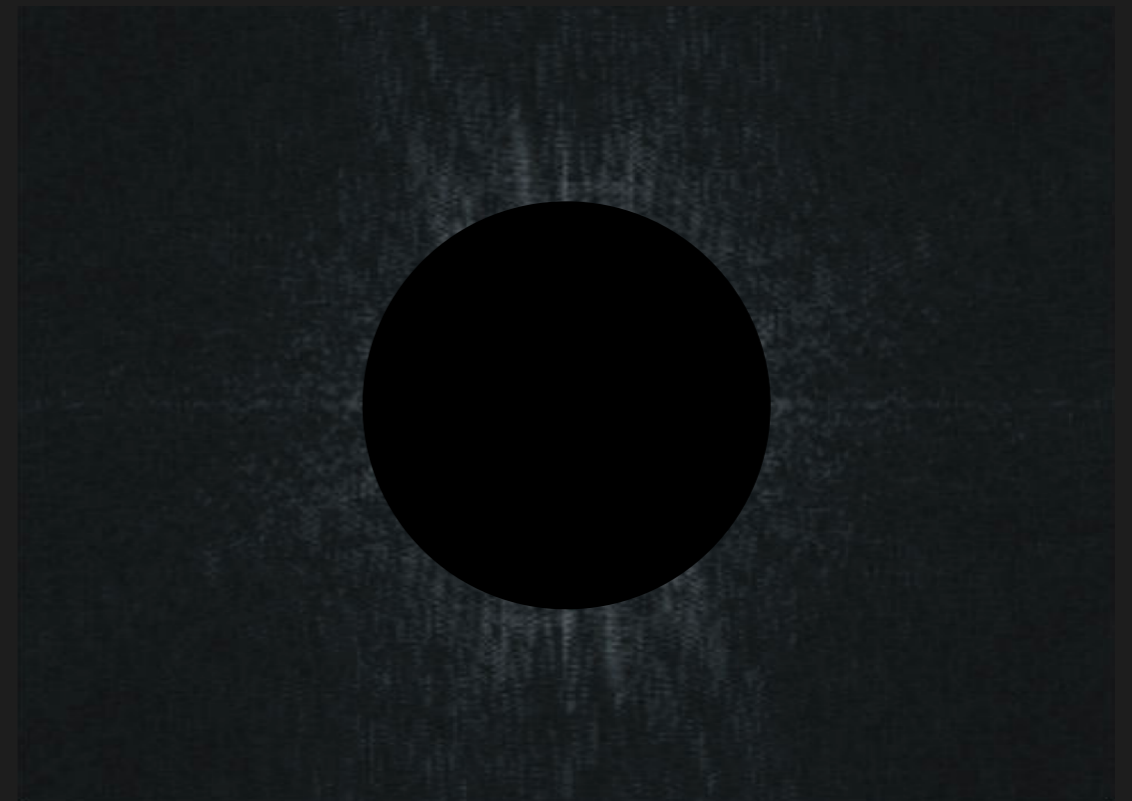
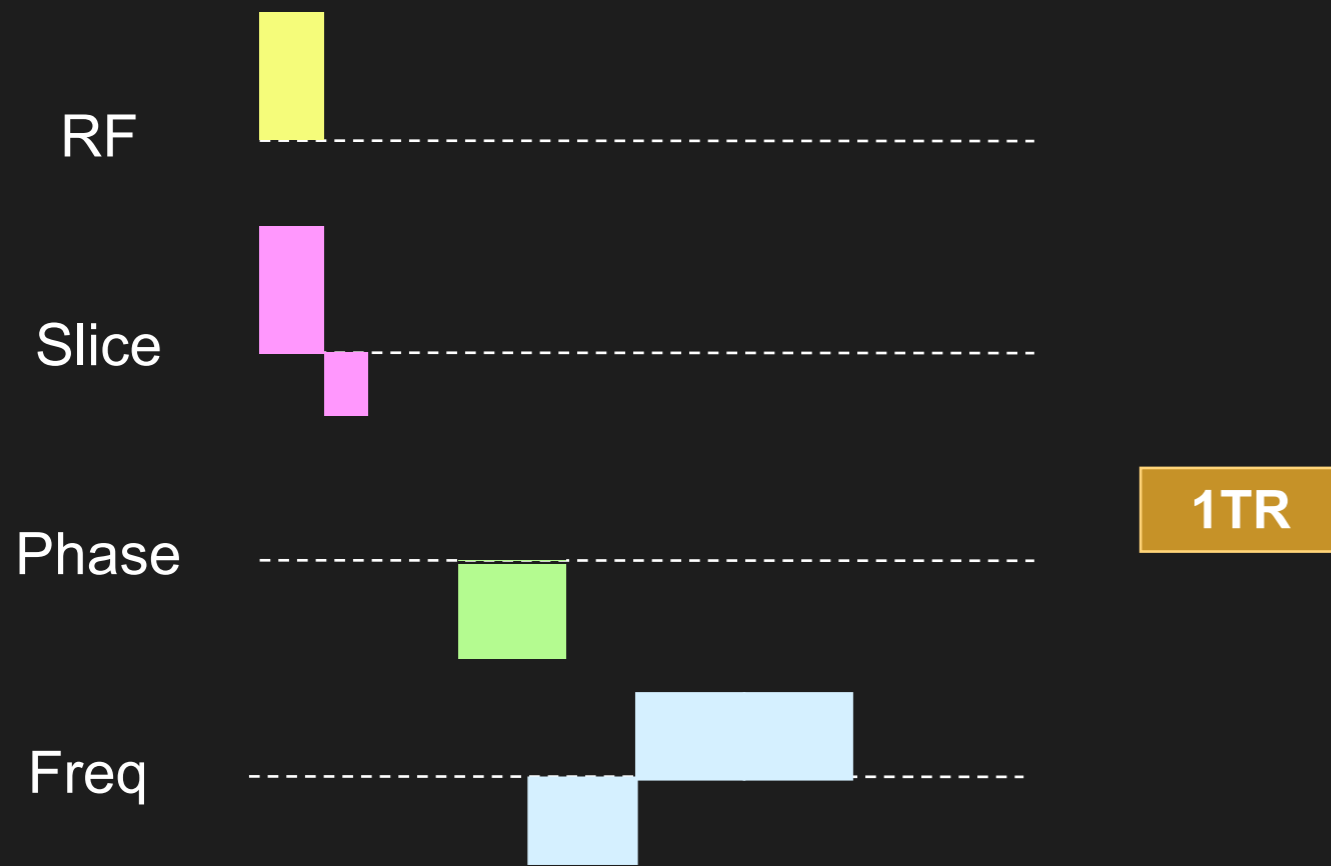

Full image

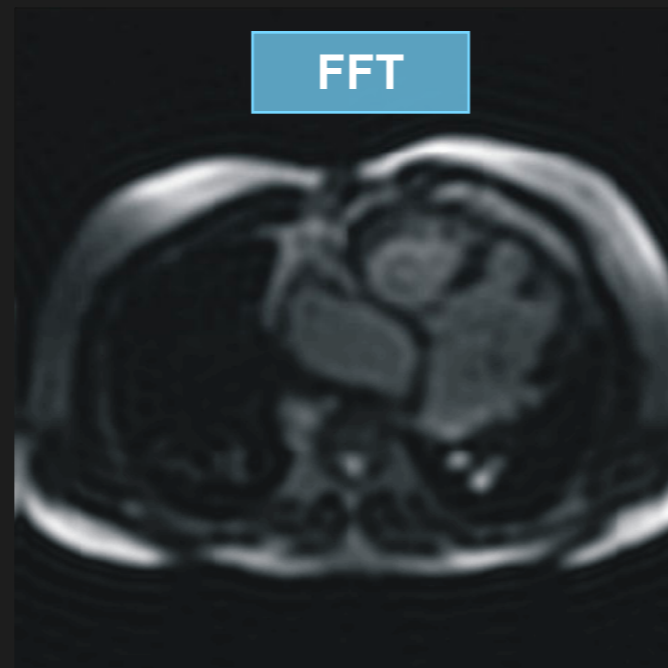

Low resolution - contrast

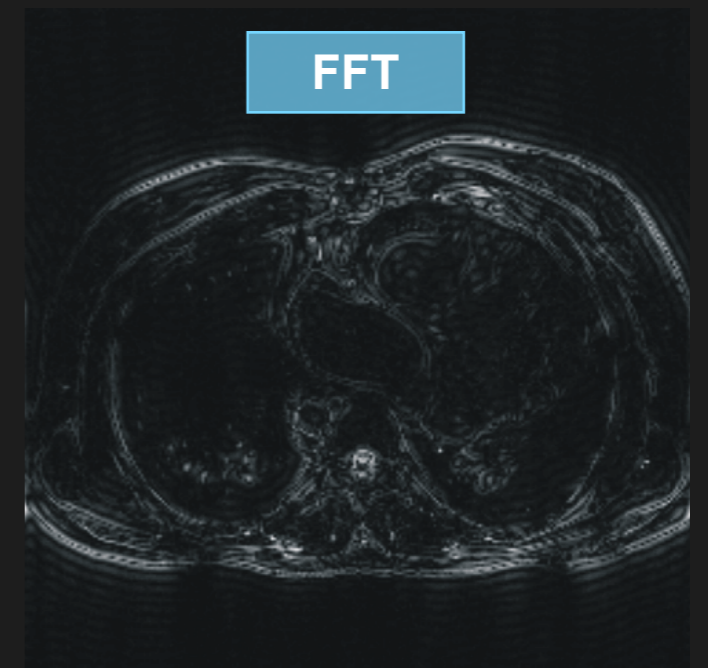

High resolution - edges

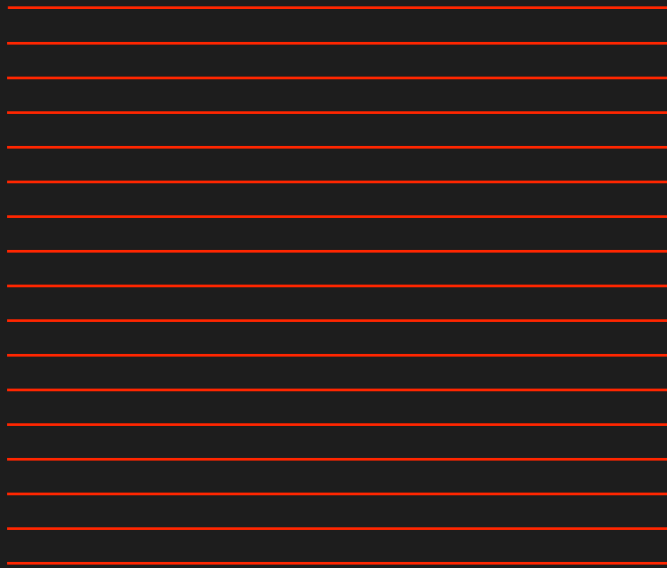

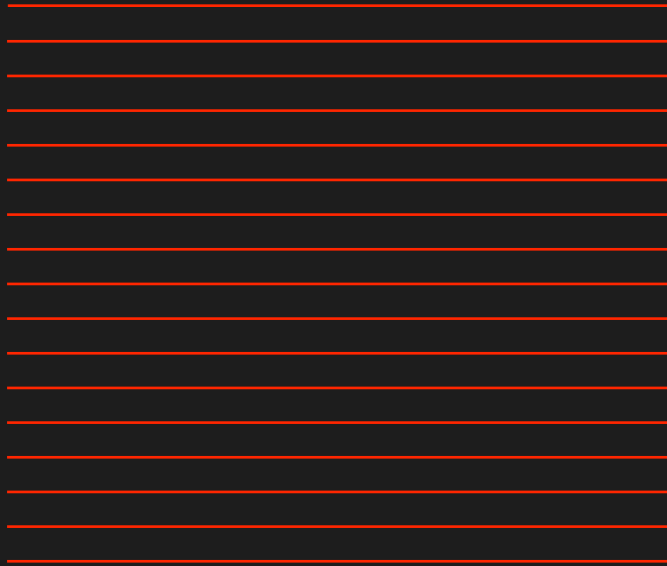



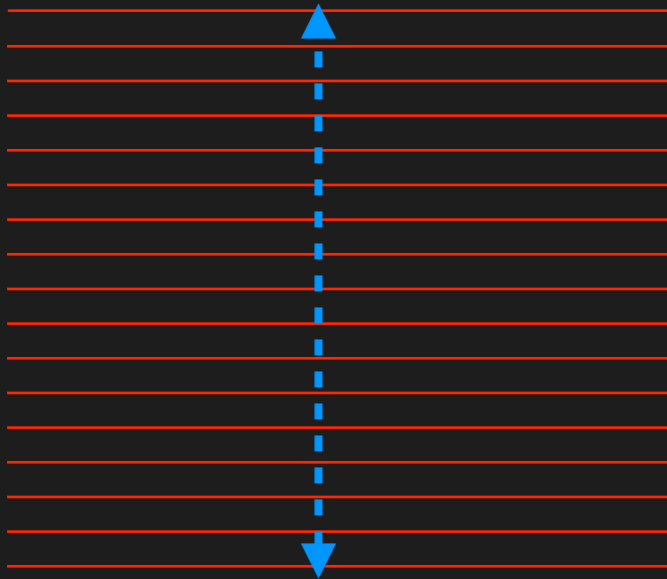

Resolution - size of K-space



Resolution - size of K-space

Increase line spacing

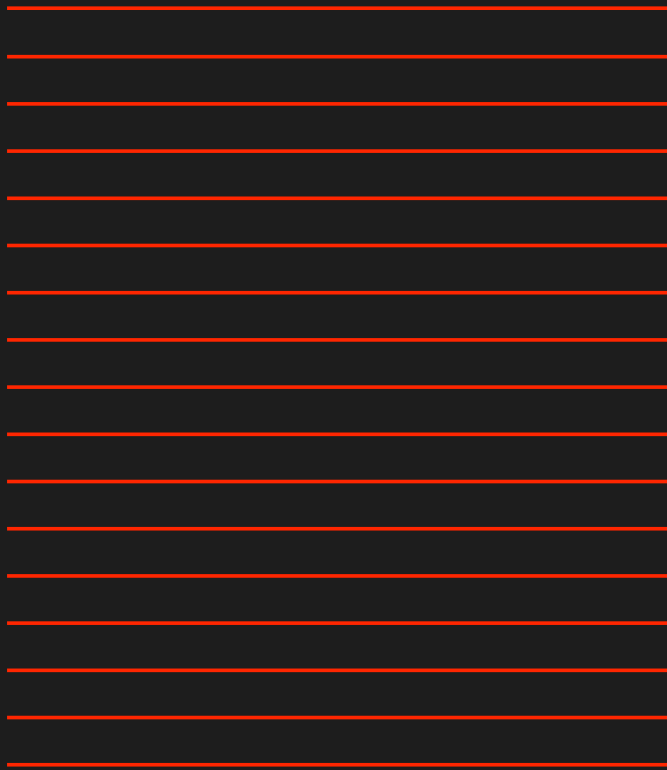

Resolution - size of K-space

Increase line spacing

How do we do that?

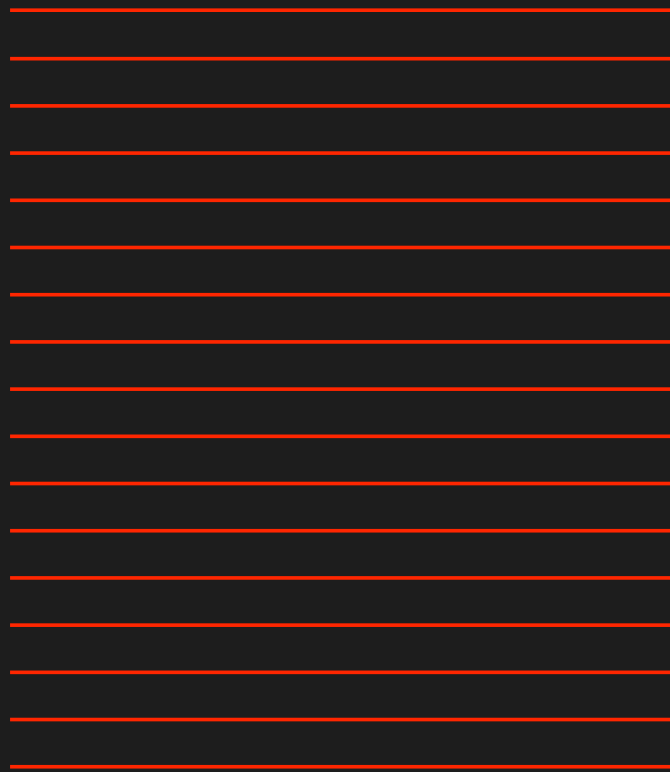

Resolution - size of K-space

Increase line spacing

How do we do that?

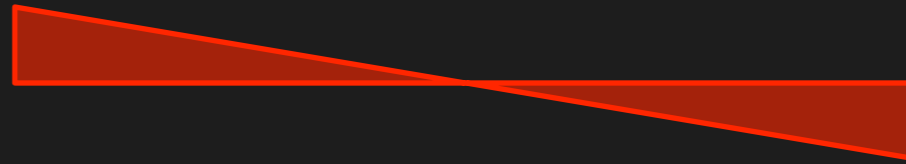

Resolution - size of K-space

Increase line spacing

How do we do that?

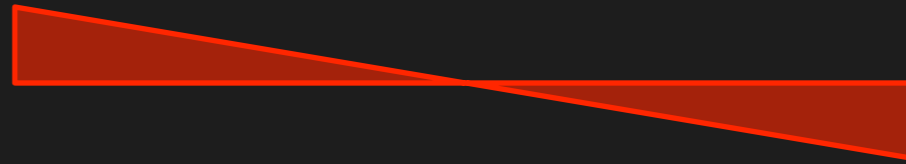

Resolution - size of K-space

Increase line spacing

How do we do that?

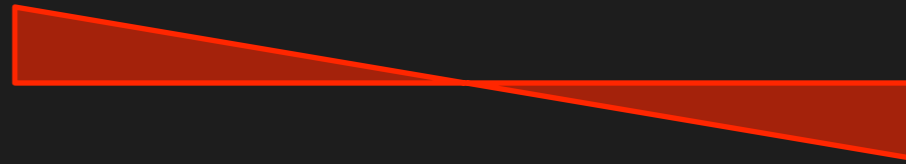

Resolution - size of K-space

Increase line spacing

How do we do that?

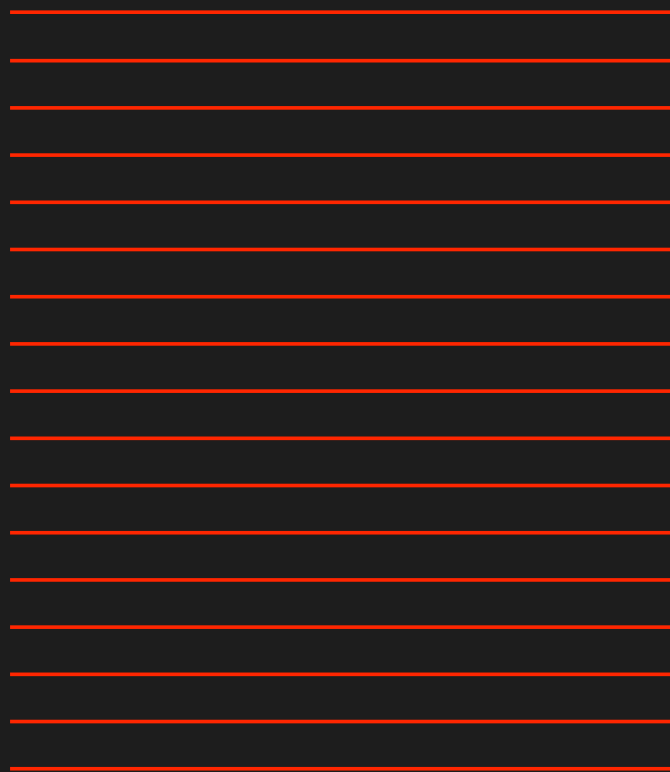

Larger gradient more dephasing

Resolution - size of K-space

Increase line spacing

How do we do that?



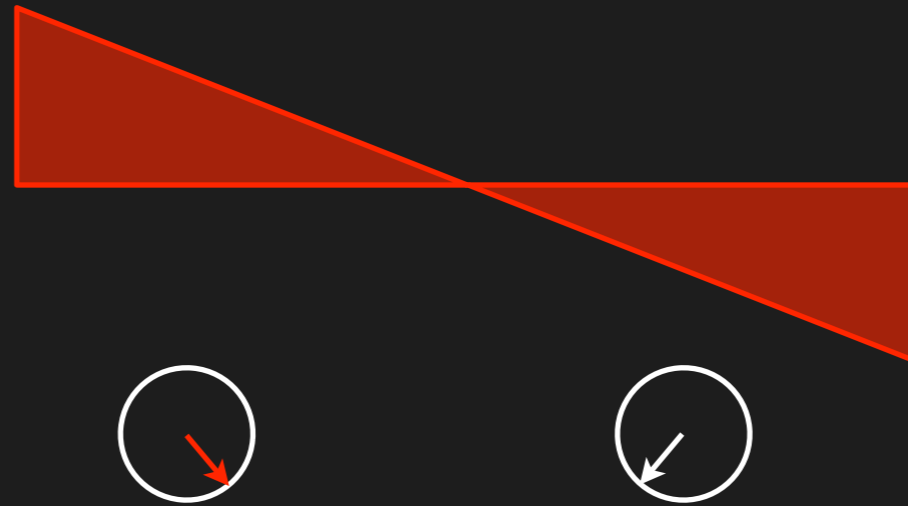

Larger gradient more dephasing

Resolution - size of K-space

Increase line spacing

How do we do that?



Resolution - size of K-space

Increase line spacing

How do we do that?

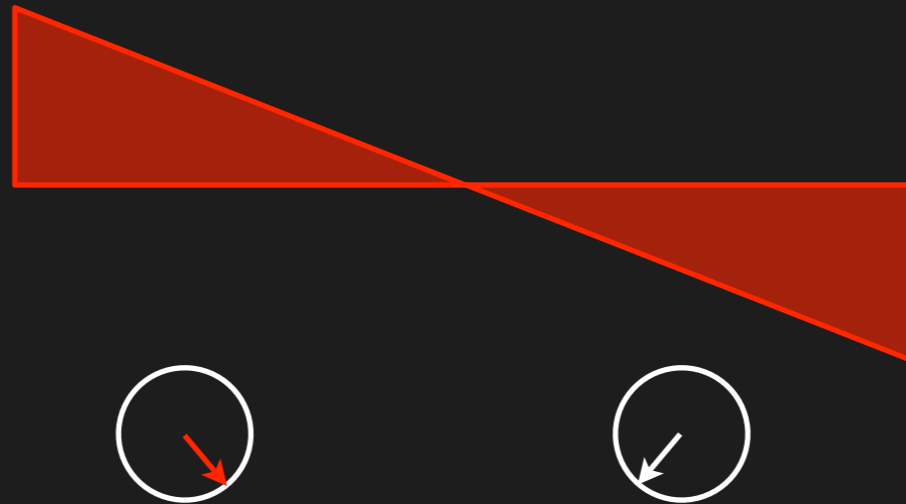

Larger gradient more dephasing

Limited by aliasing - 360 phase

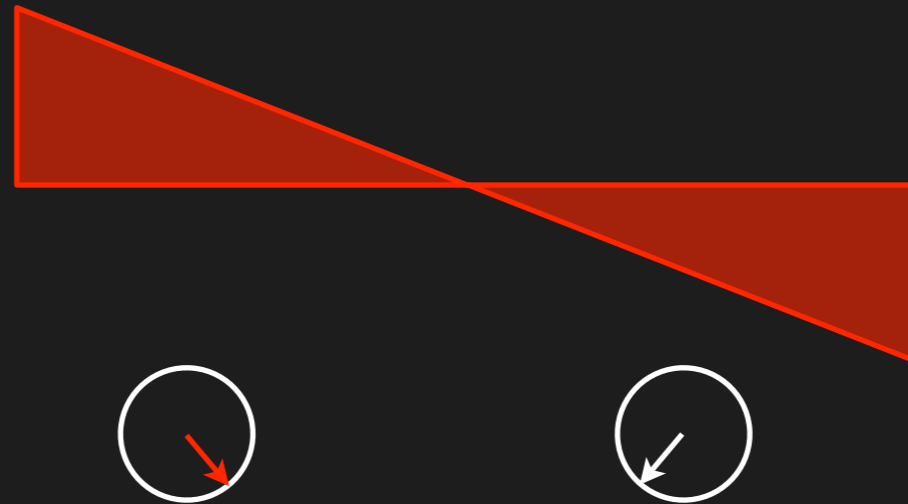

Larger gradient more dephasing

Limited by aliasing - 360 phase

Resolution - size of K-space

Increase line spacing

How do we do that?

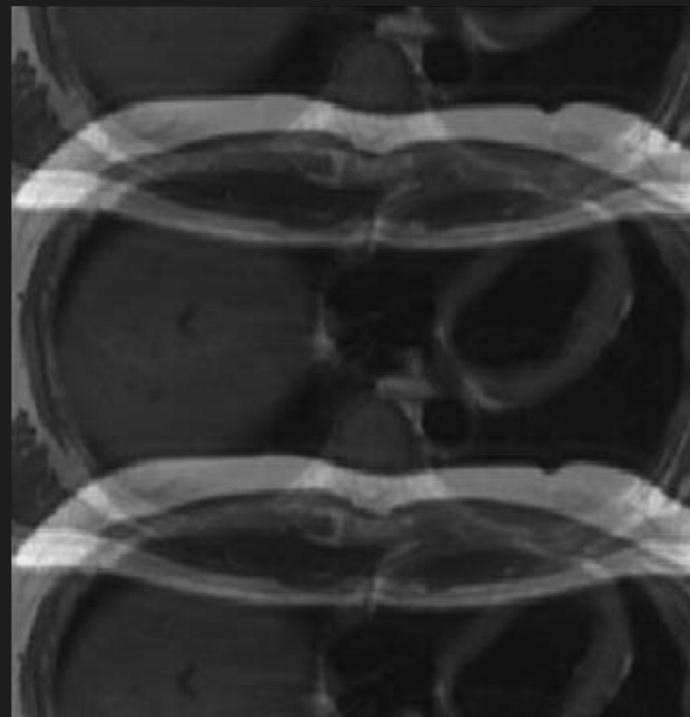

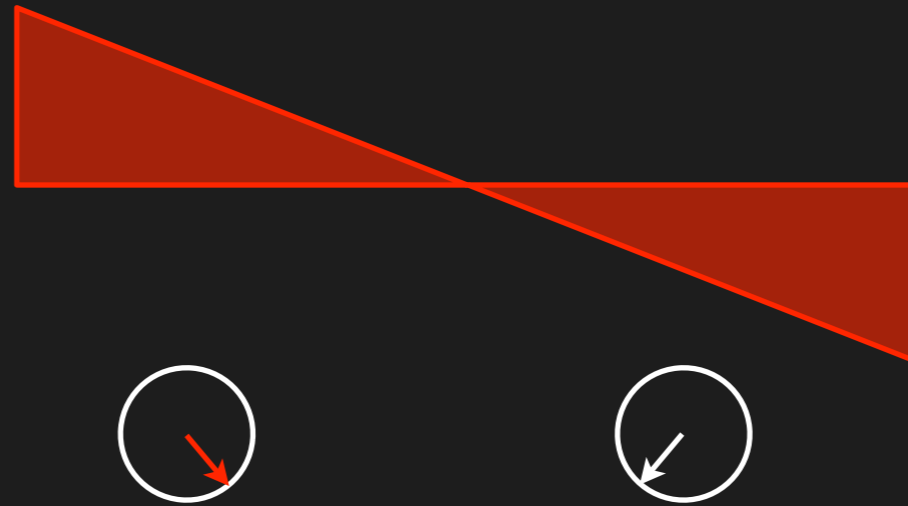
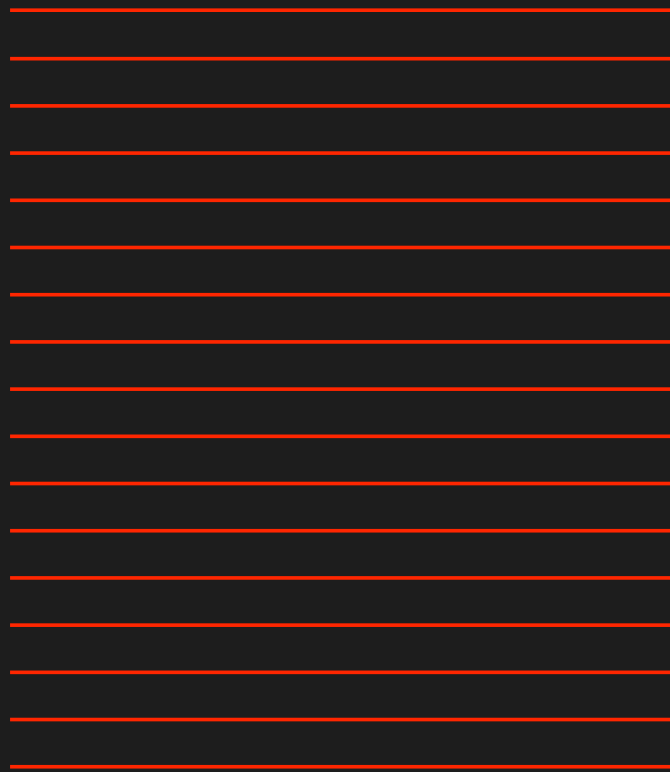

Larger gradient more dephasing

Limited by aliasing - 360 phase

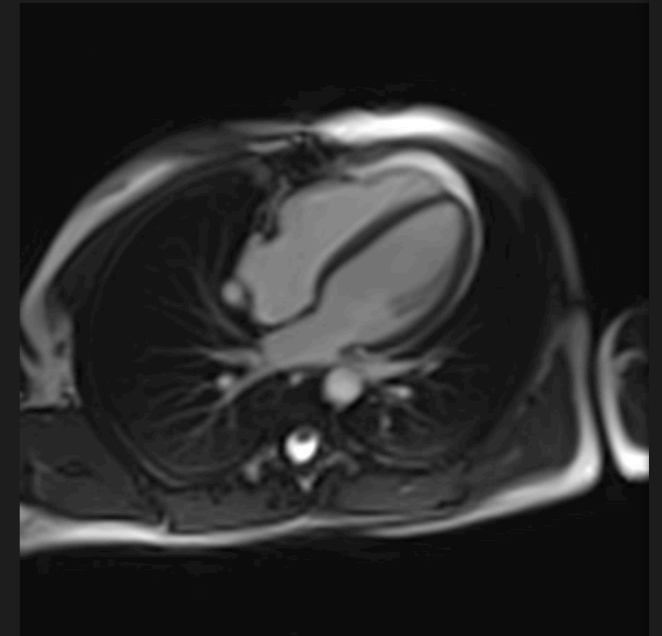

FOV = 500mm  
Matrix = 176\*176  
Scan time = 15s

Resolution - size of K-space

Increase line spacing

How do we do that?

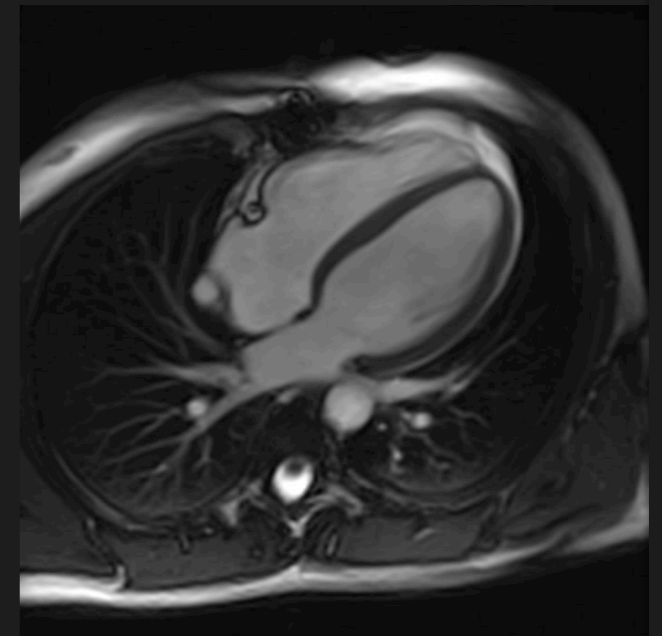

FOV = 300mm  
Matrix = 176\*176  
Scan time = 15s

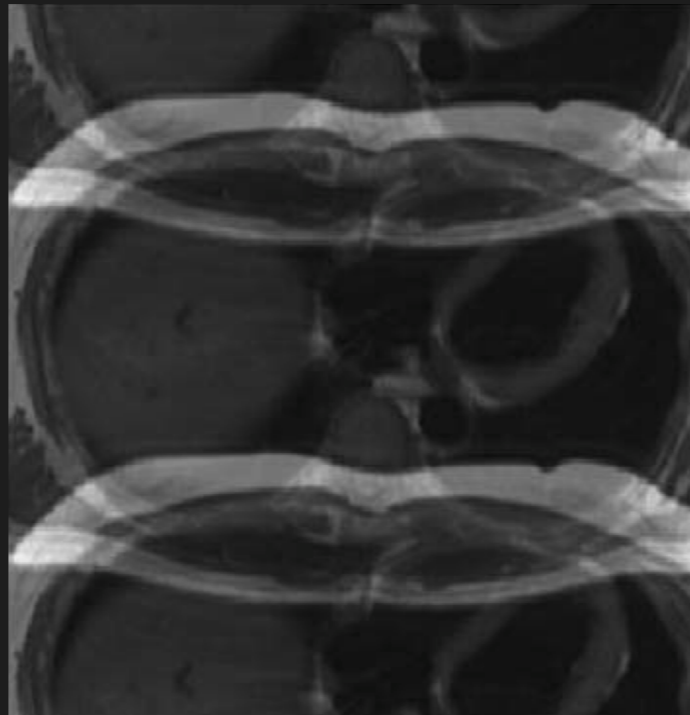

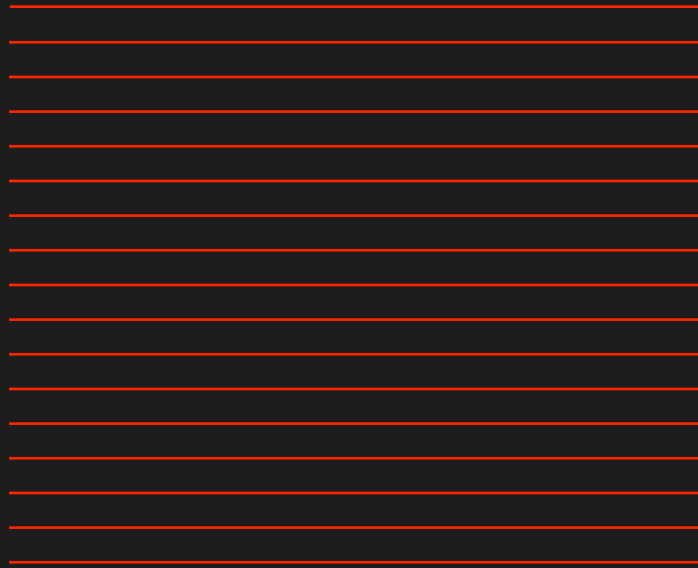

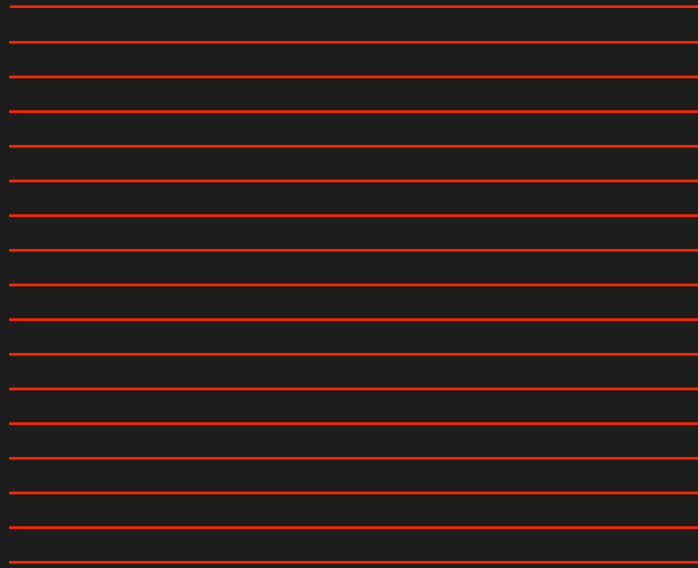

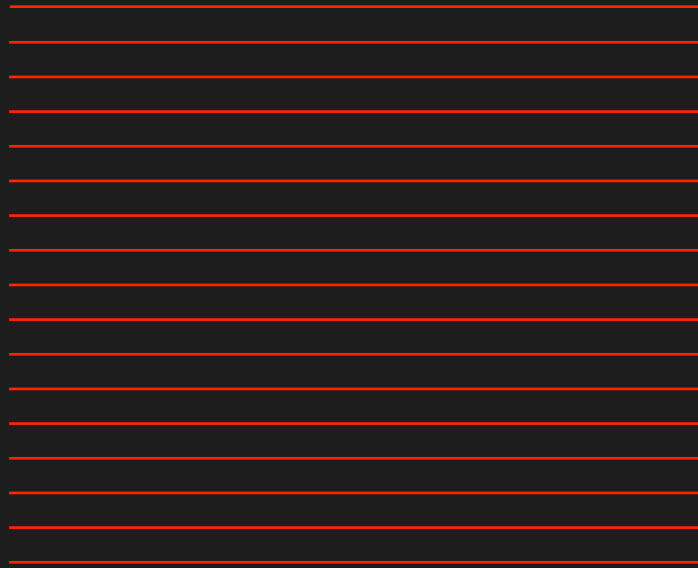

Resolution - size of K-space



Resolution - size of K-space

Increase number of lines





**Resolution - size of K-space**

**Increase number of lines**

**How do we do that?**

Increase matrix

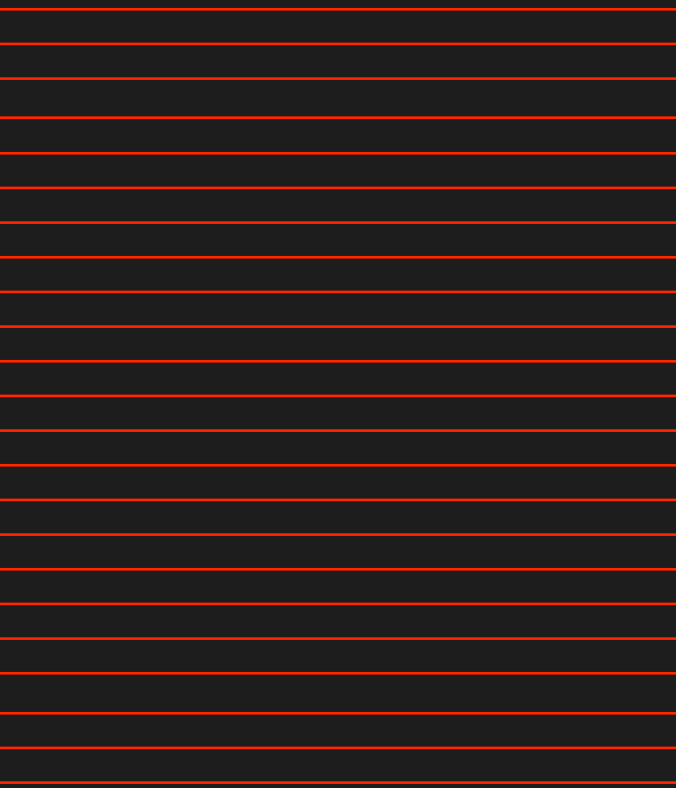

Resolution - size of K-space

Increase number of lines

How do we do that?

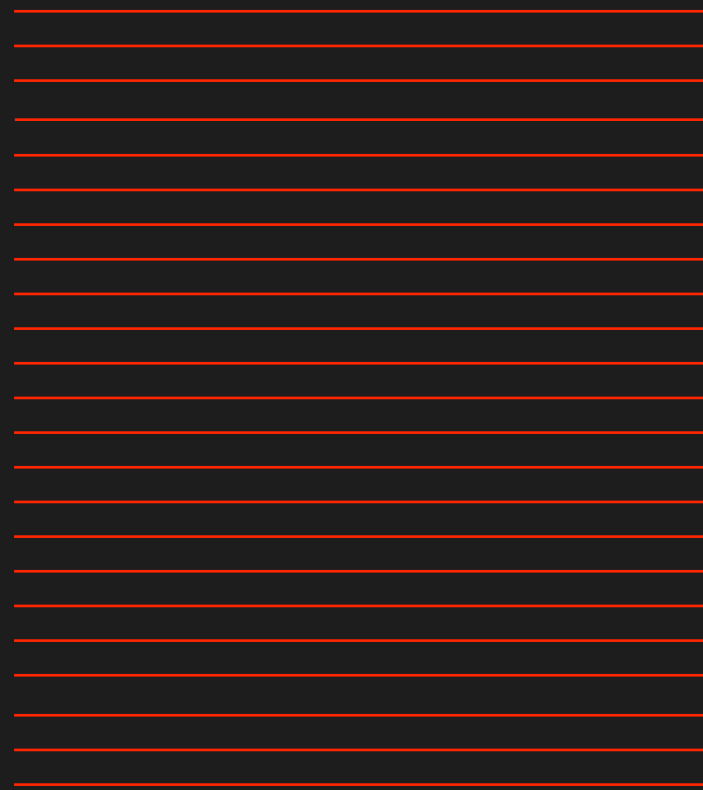

Increase matrix

Increased time

Resolution - size of K-space

Increase number of lines

How do we do that?

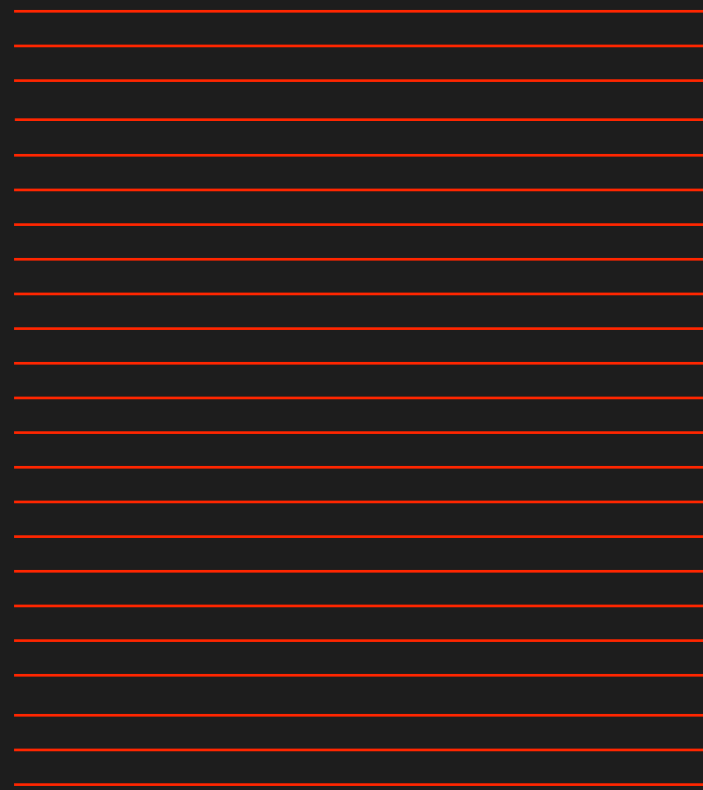

Increase matrix

Increased time

Resolution - size of K-space

Increase number of lines

How do we do that?

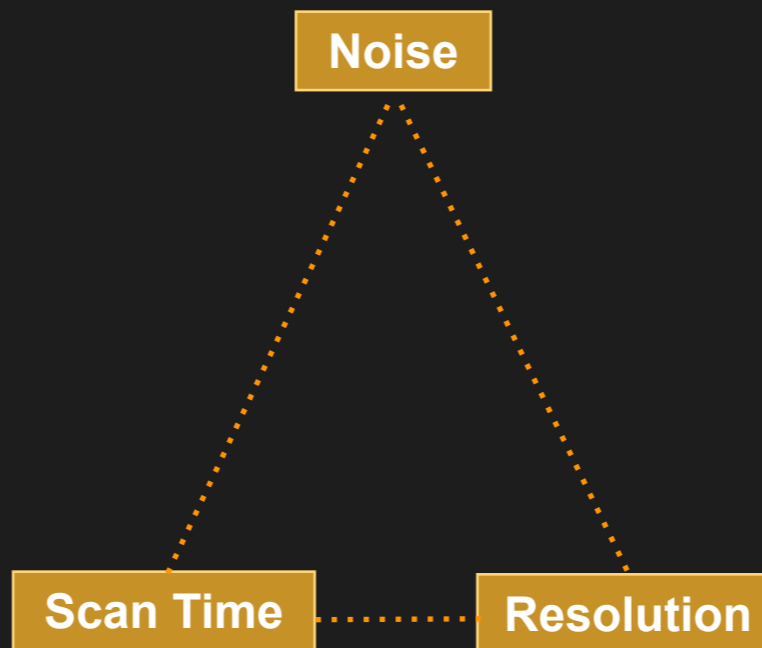



Increase matrix

Increased time

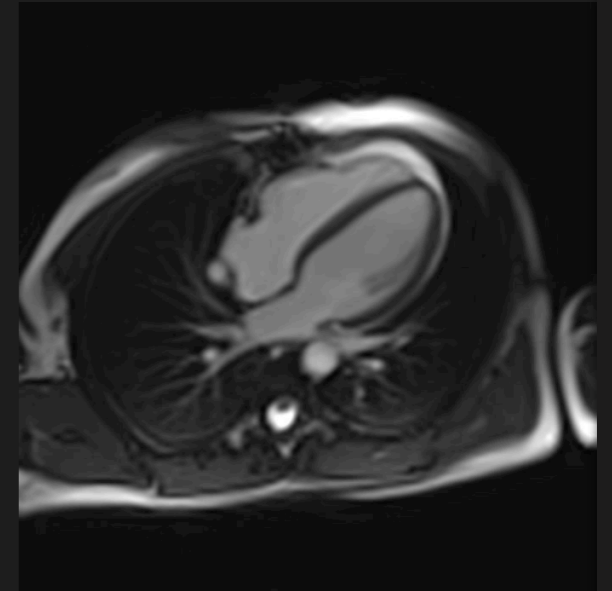

FOV = 500mm  
Matrix = 176\*176  
Scan time = 15s

Noise

Resolution - size of K-space

Increase number of lines

Scan Time

Resolution



FOV = 500mm  
Matrix = 240\*240  
Scan time = 20s

How do we do that?

## Relaxation of NMV



## Relaxation of NMV

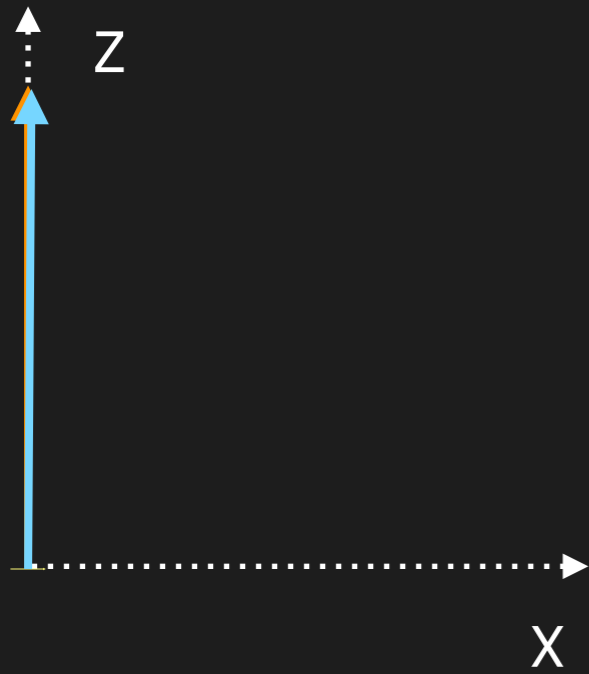

## Longitudinal recovery (T1)

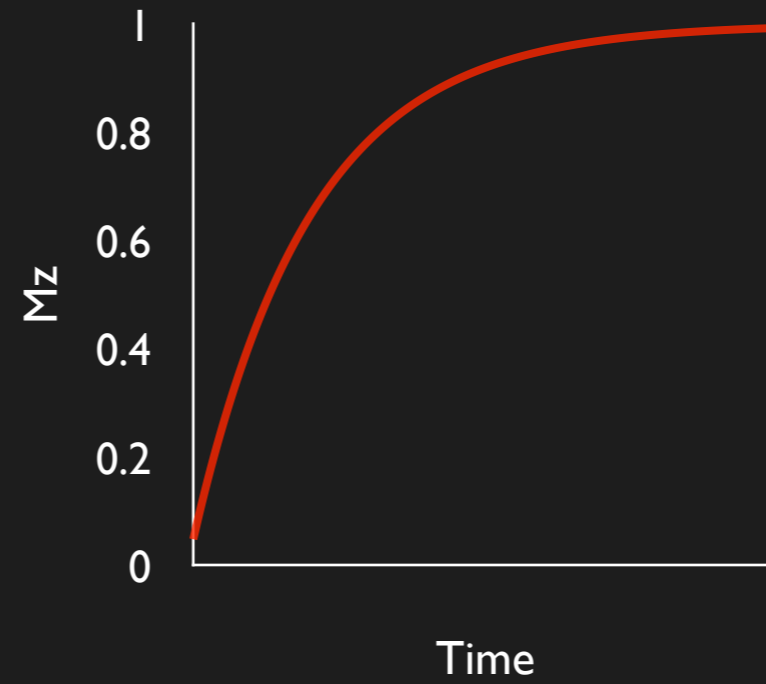

long T1

## Relaxation of NMV

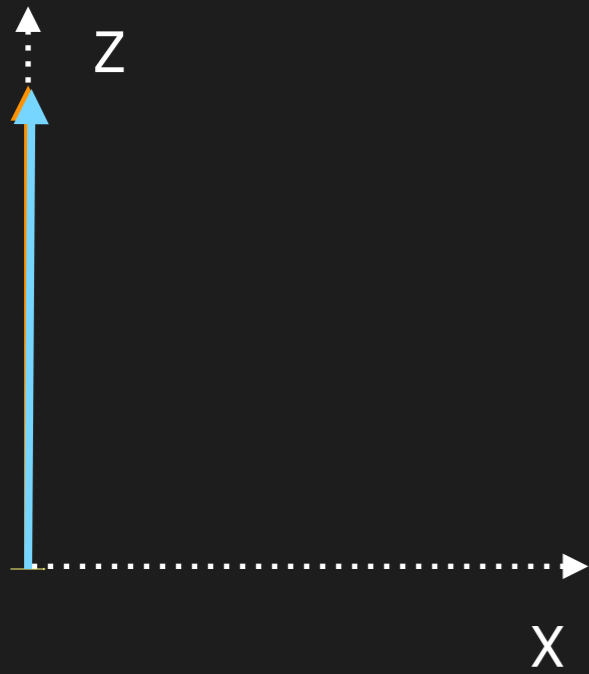

## Longitudinal recovery (T1)

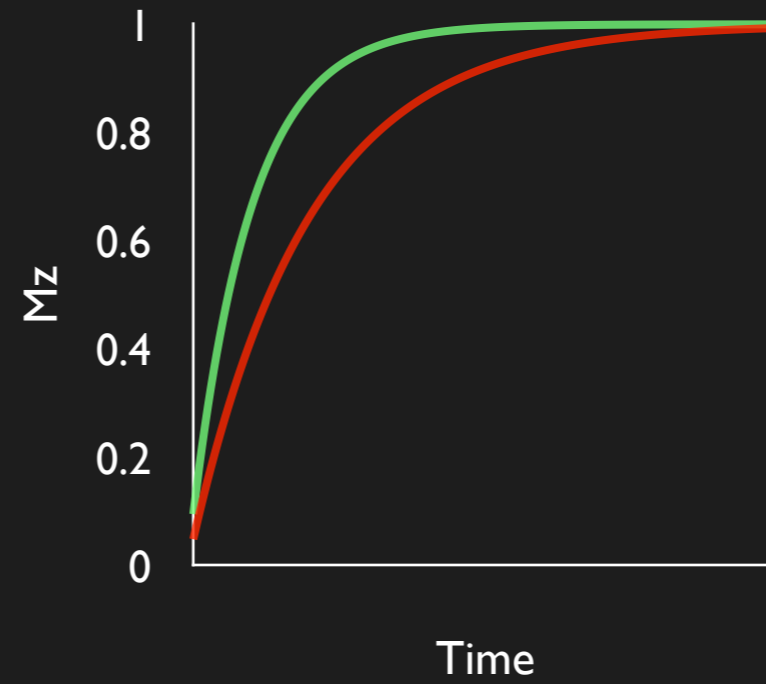

long T1

shorter T1



## Relaxation of NMV

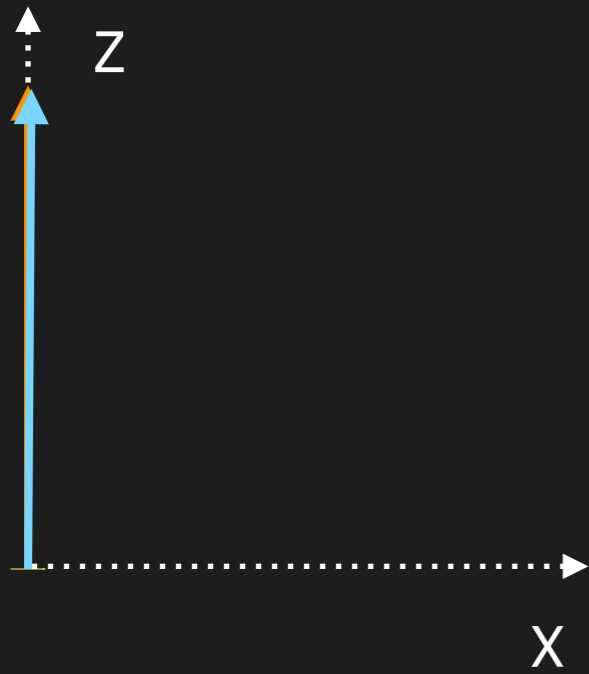

## Longitudinal recovery (T1)

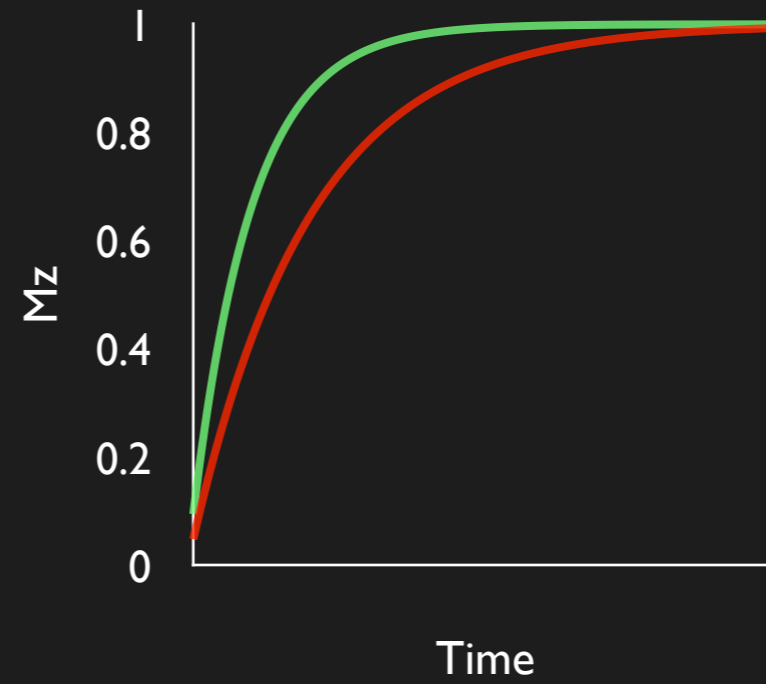

long T1

shorter T1

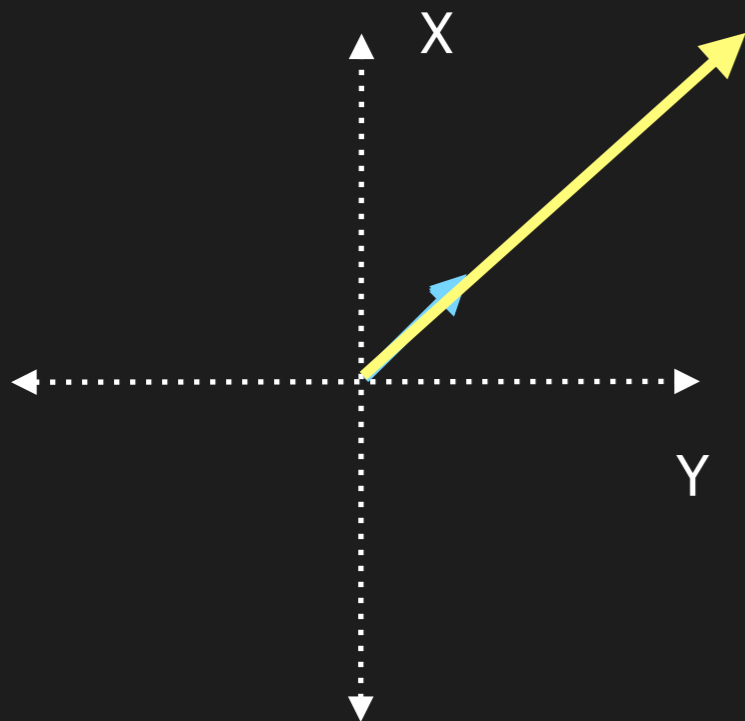

## Relaxation of NMV

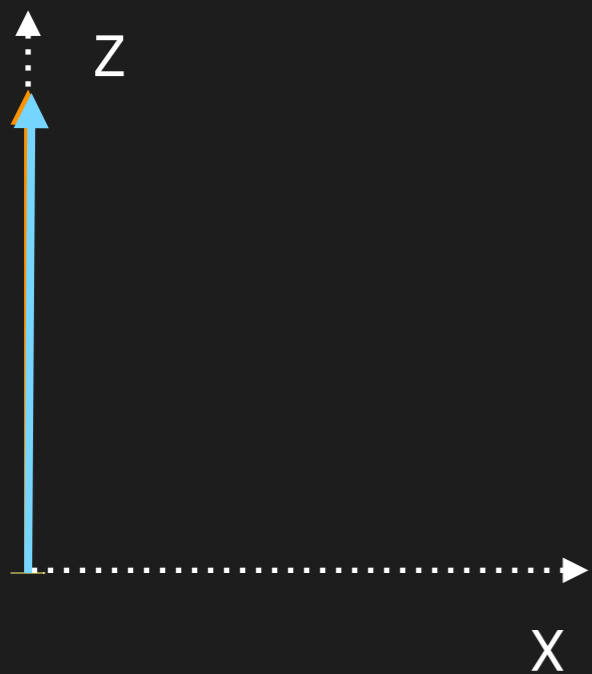

## Longitudinal recovery (T1)

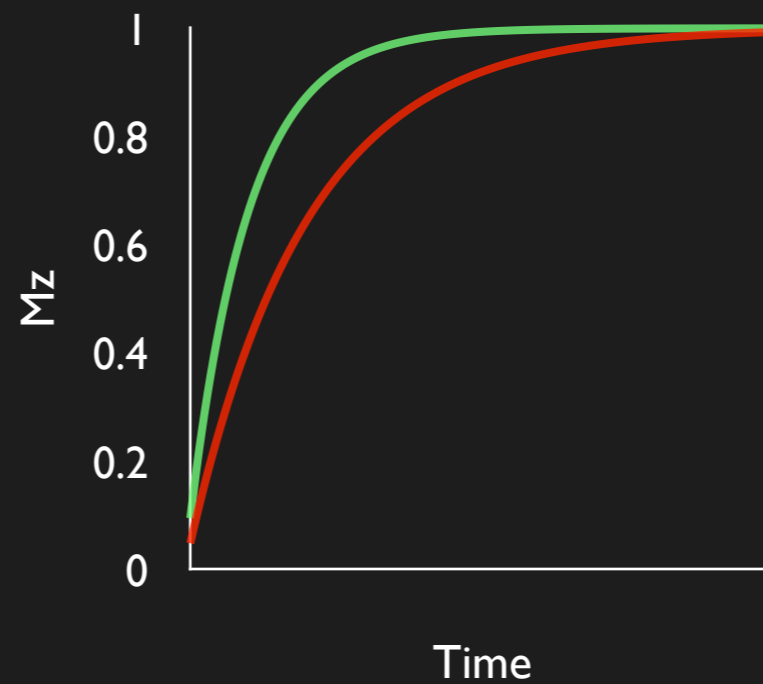

long T1

shorter T1

## Transverse relaxation (T2)

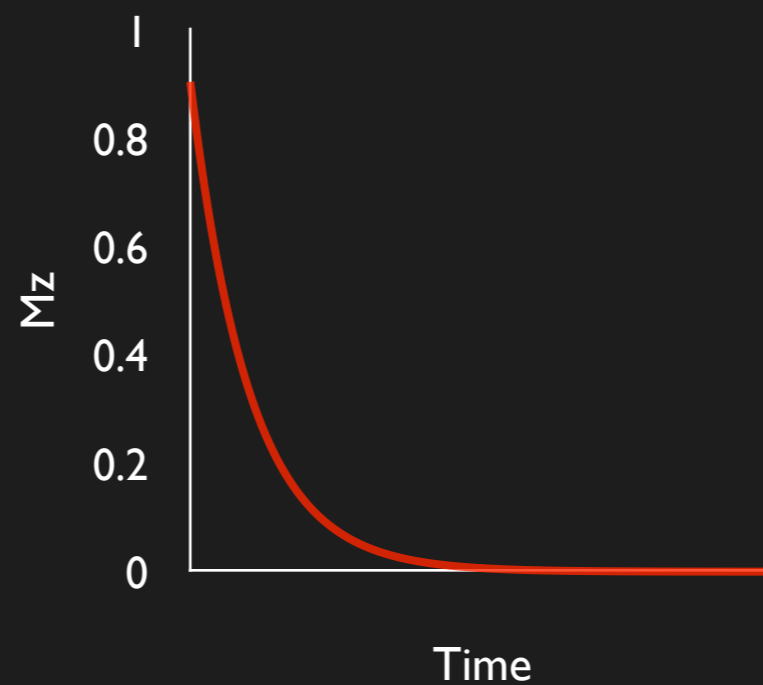
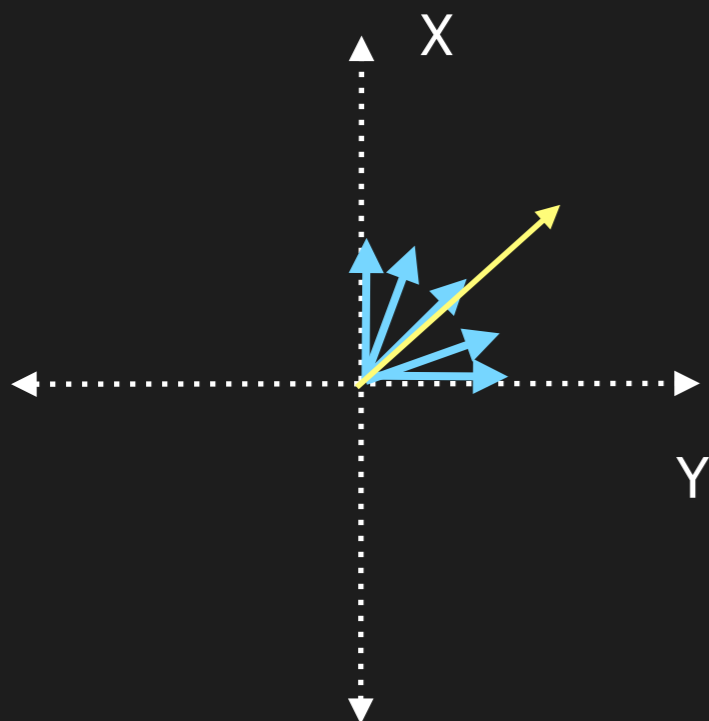

Short T2 or T2\*

## Relaxation of NMV

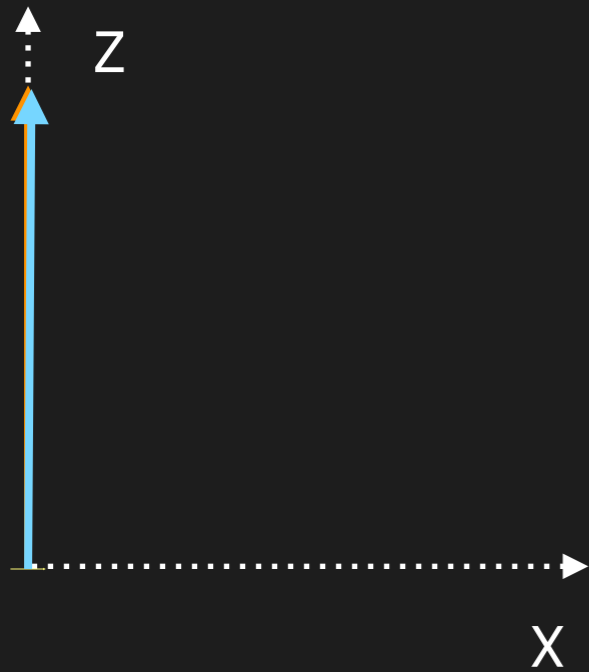

## Longitudinal recovery (T1)

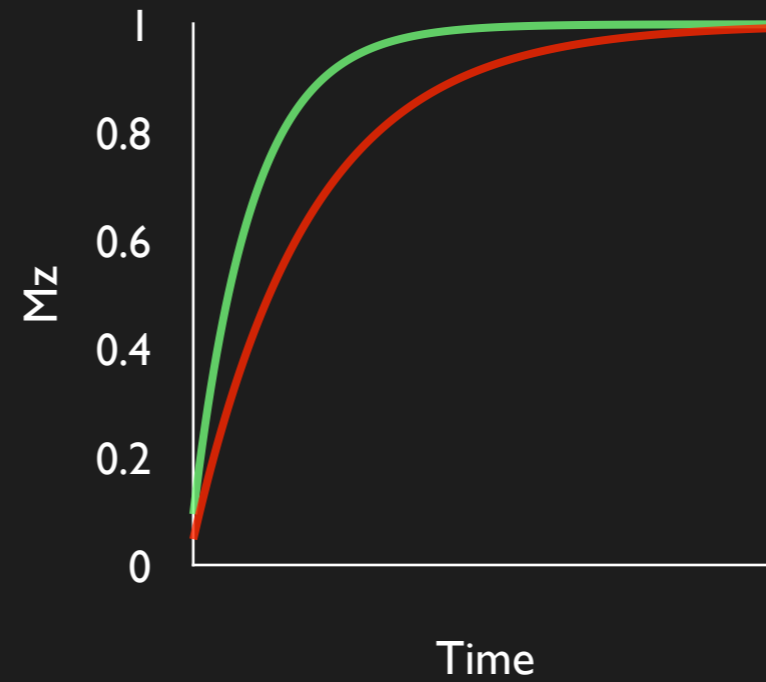

long T1

shorter T1

## Transverse relaxation (T2)

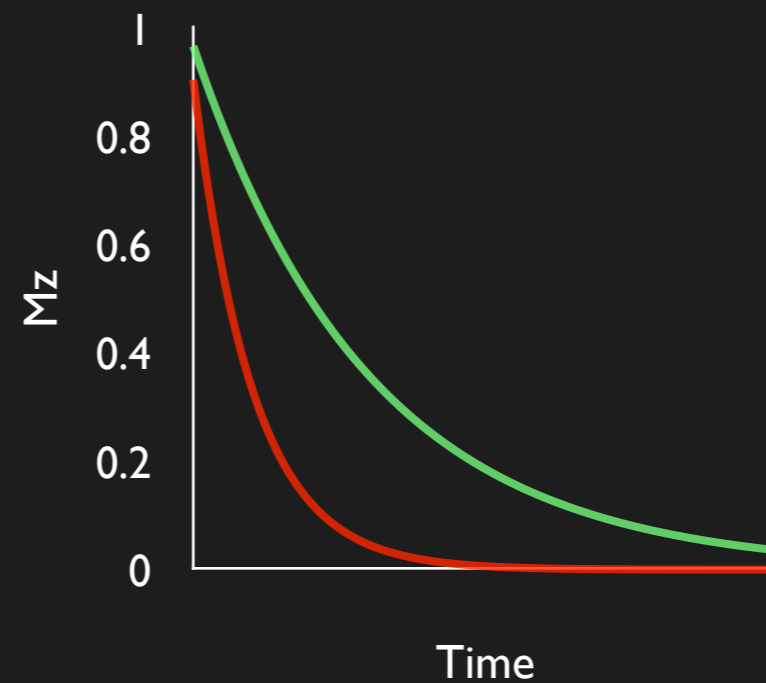
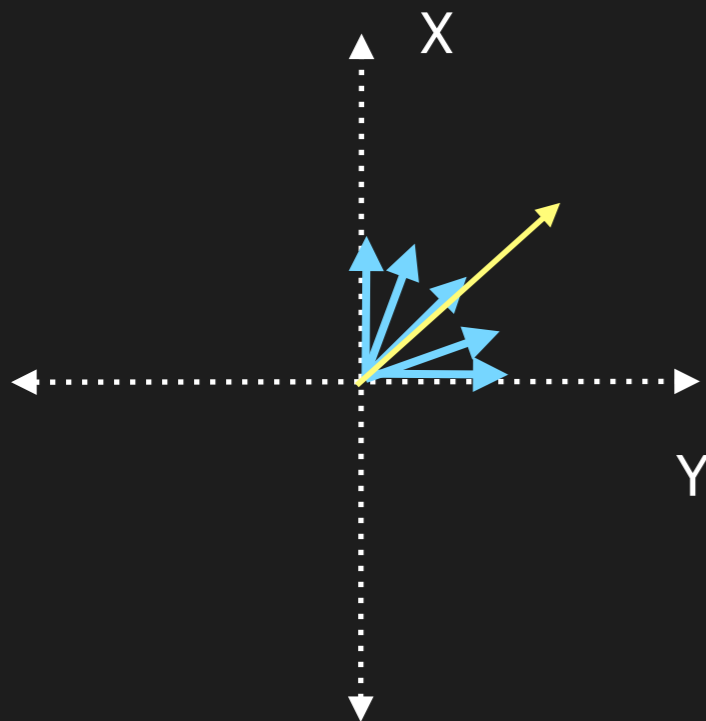

Short T2 or T2\*

Longer T2

# T1 and T2 weighting



# T1 and T2 weighting

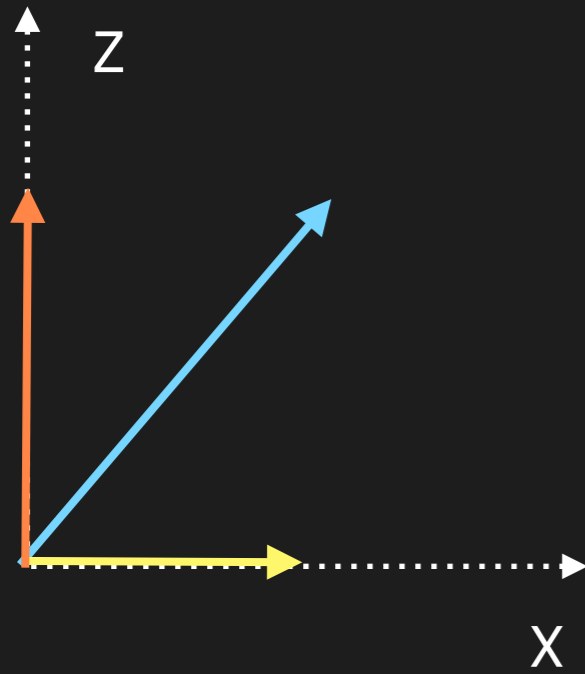

# T1 and T2 weighting

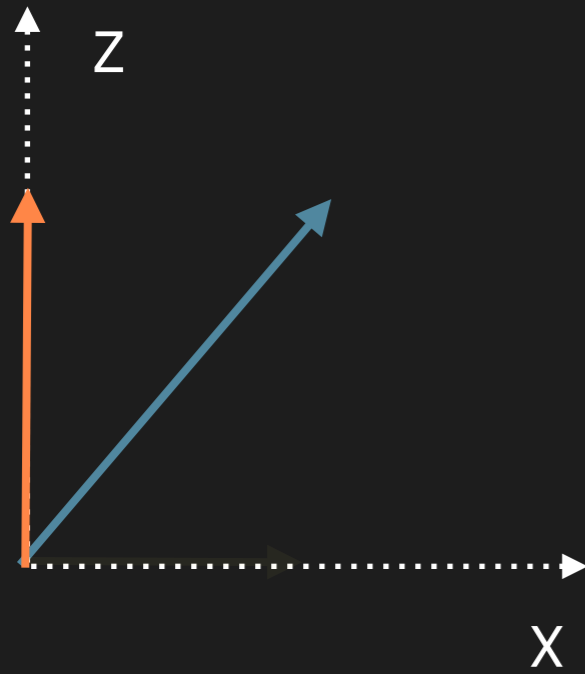

# T1 and T2 weighting

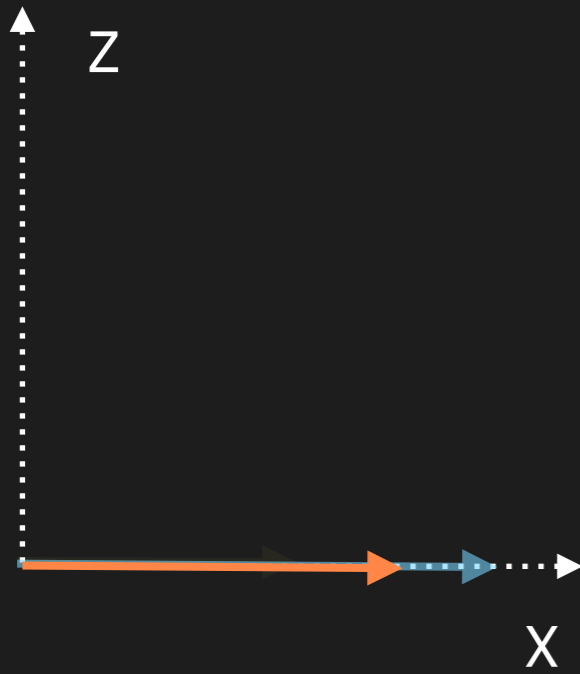

# T1 and T2 weighting

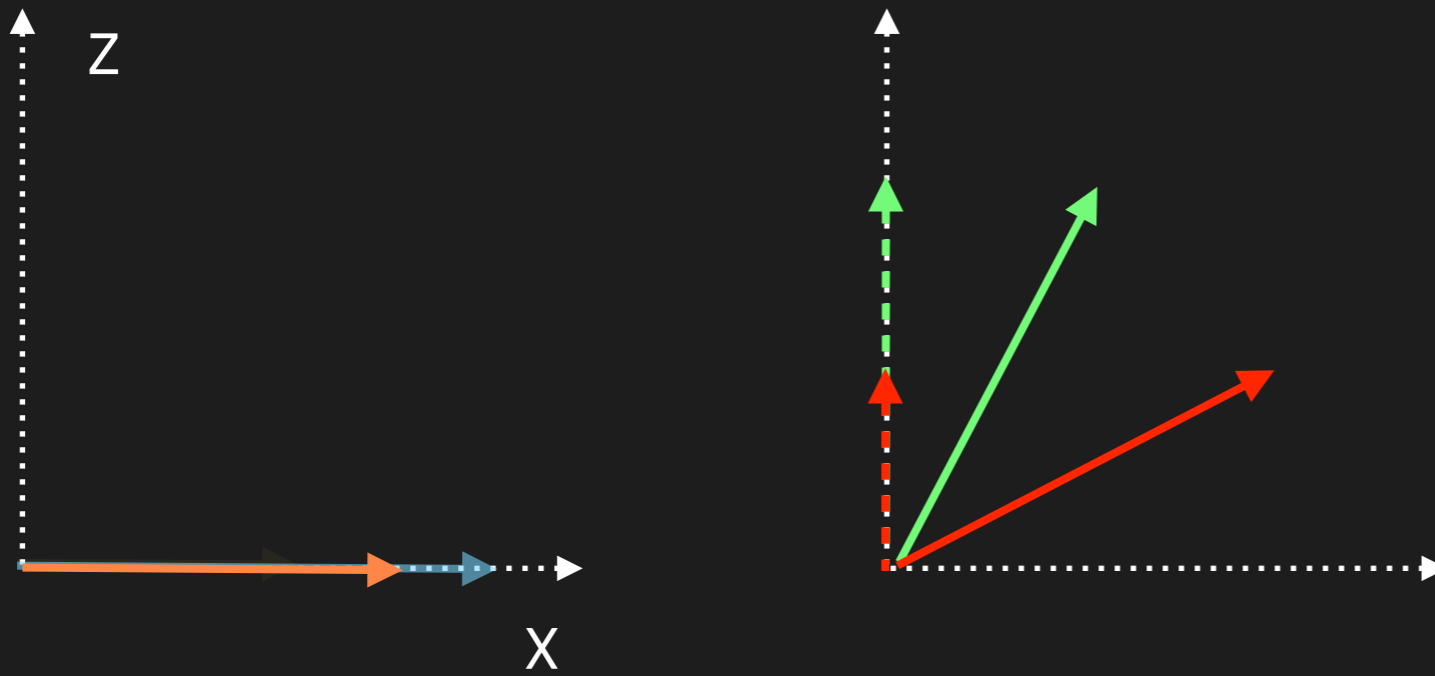



Short T1 more  $M_z$

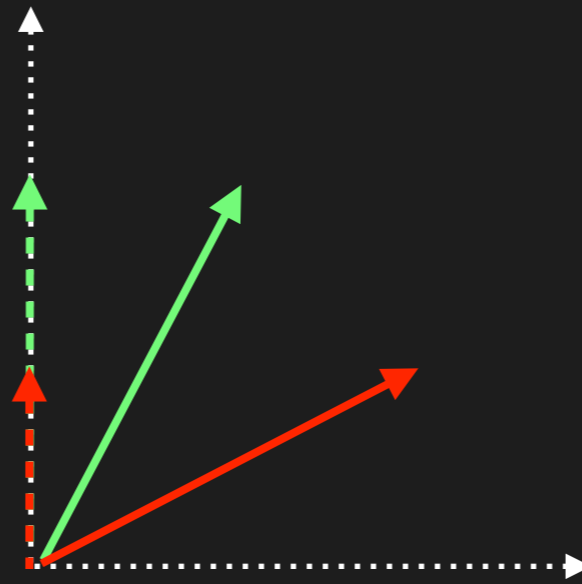
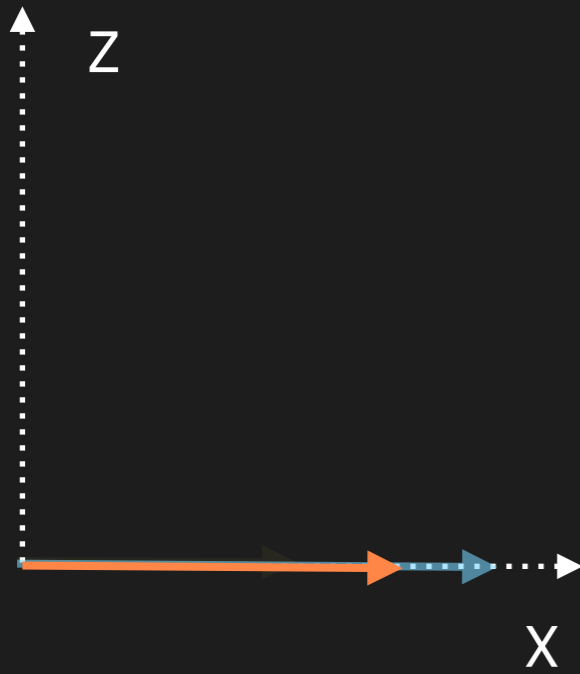

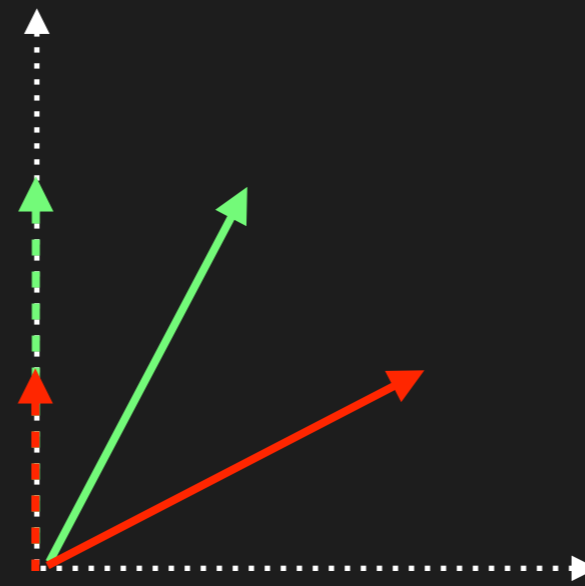
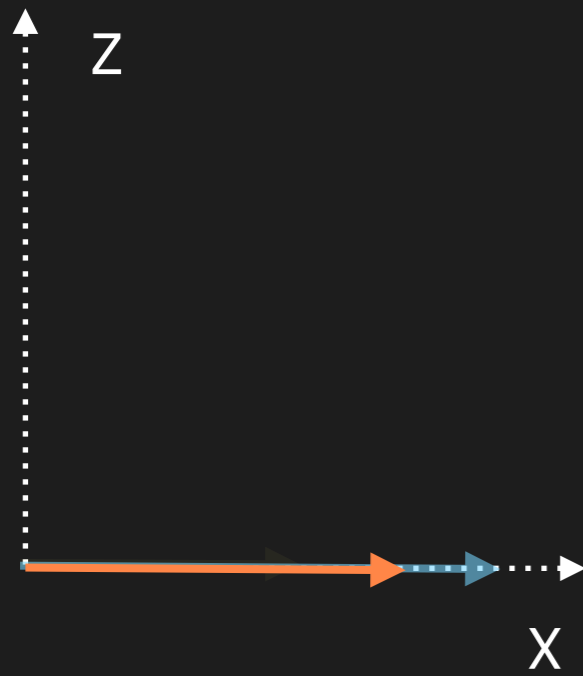

Short T1 more  $M_z$

Long T1 less  $M_z$

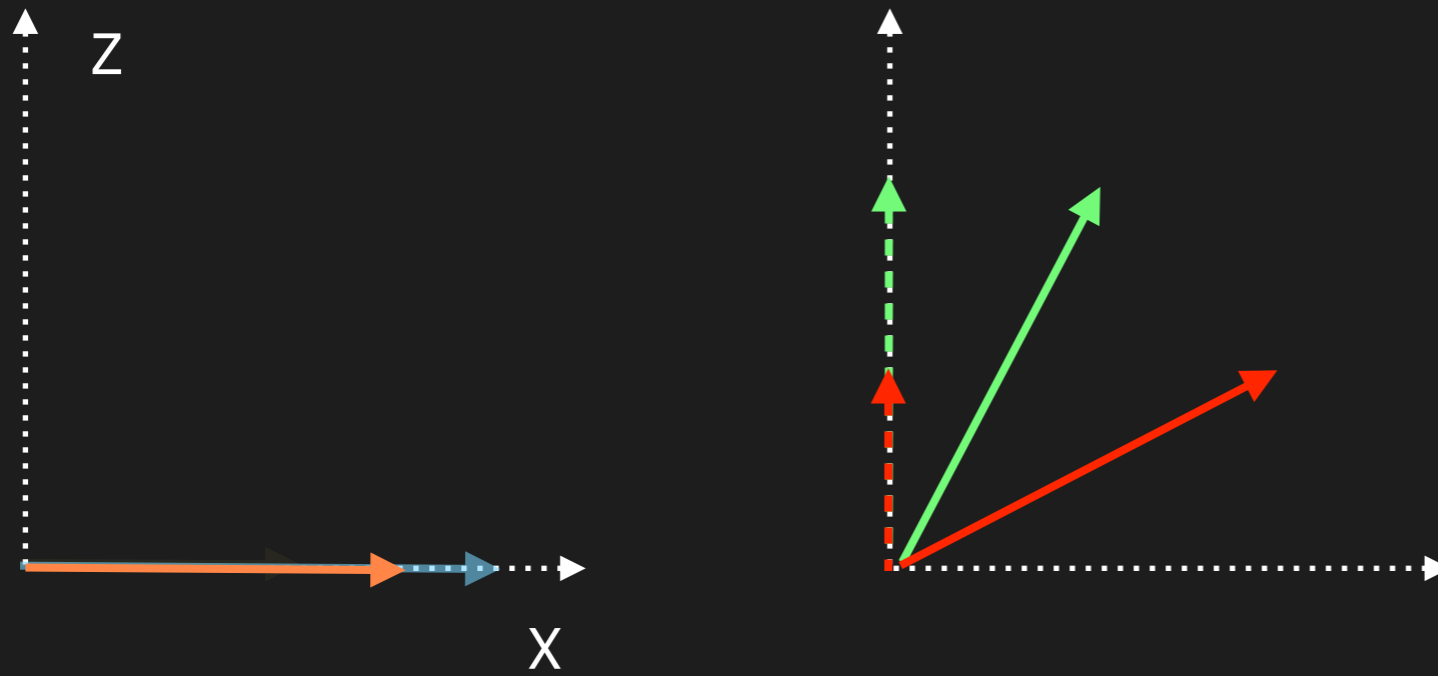

Short T1 more  $M_z$

Long T1 less  $M_z$

Short TR

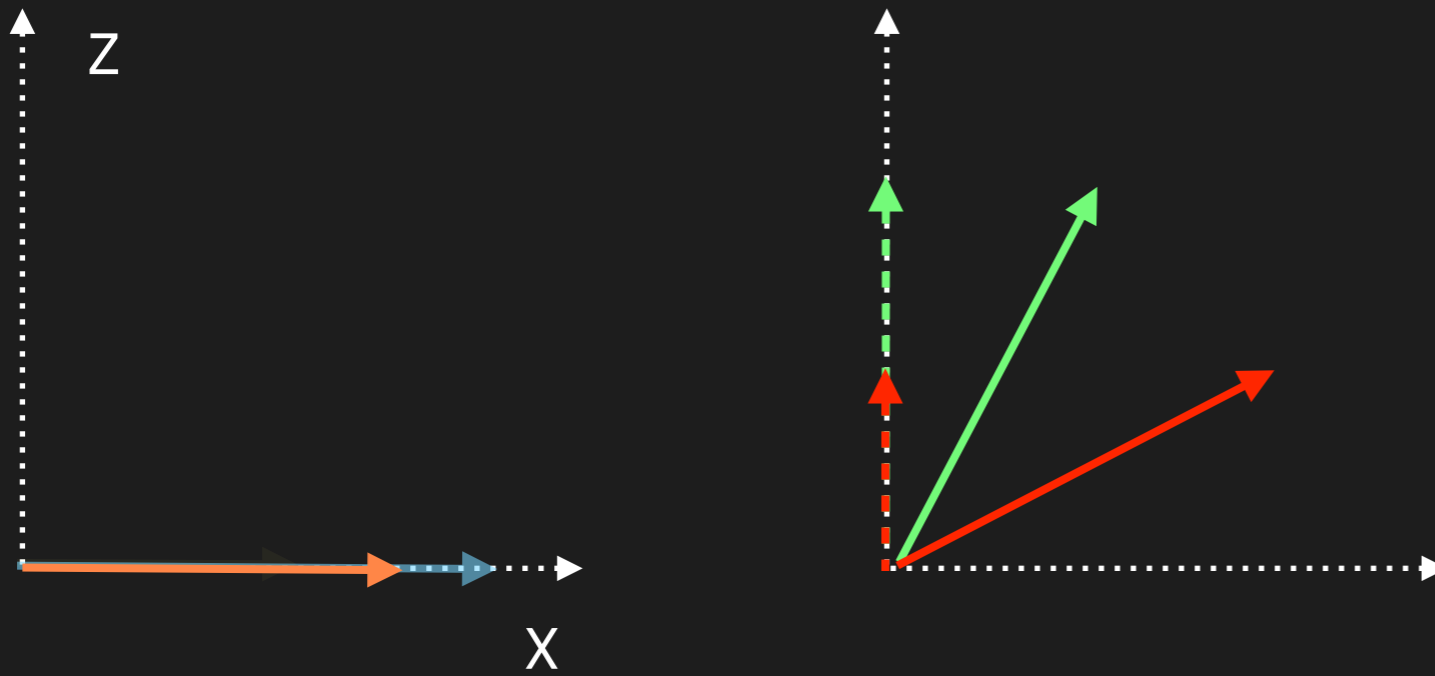

Short T1 more  $M_z$

Long T1 less  $M_z$

Short TR

Large flip angle

# T1 and T2 weighting

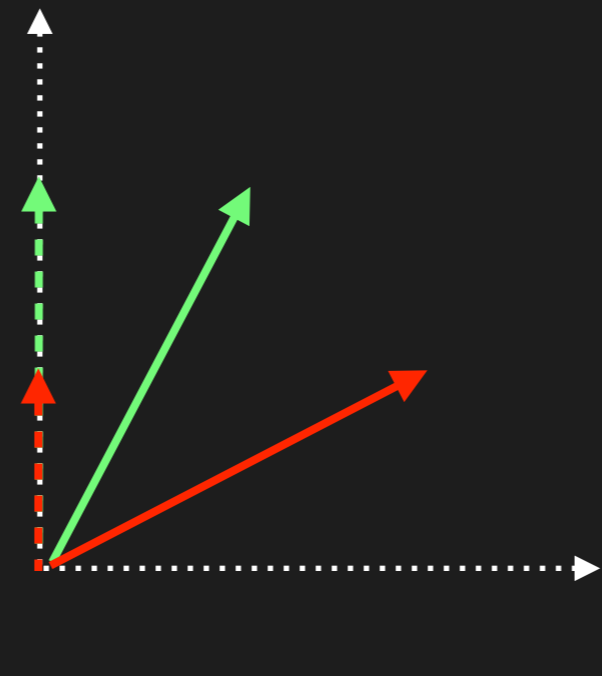
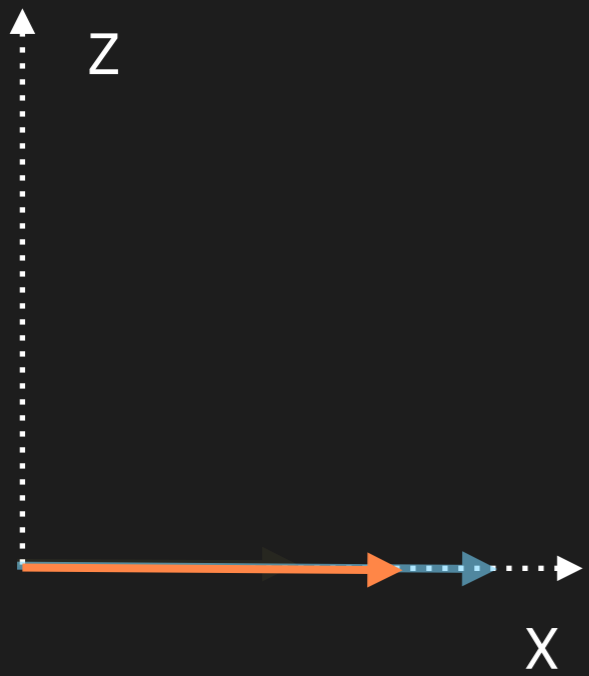

Short T1 more  $M_z$

Long T1 less  $M_z$

Short TR

Large flip angle

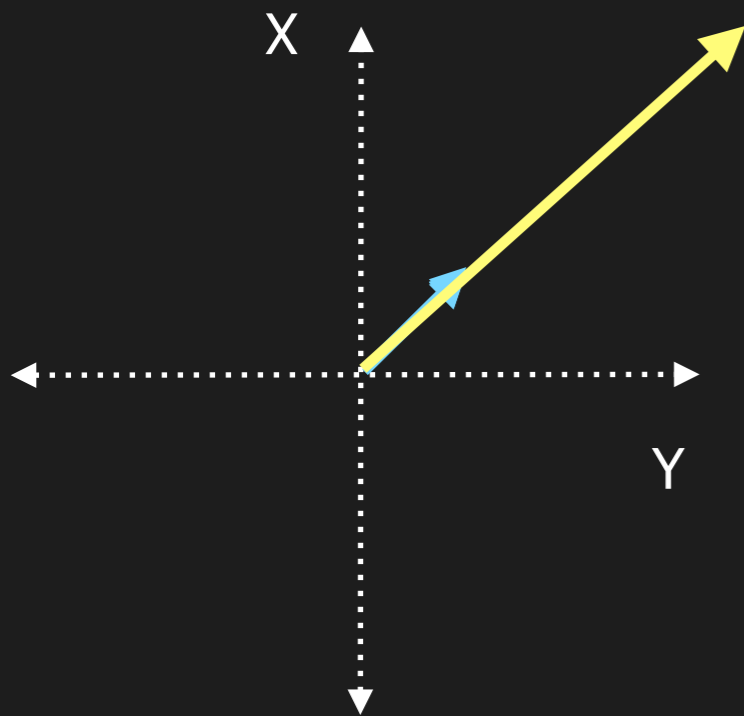

# T1 and T2 weighting

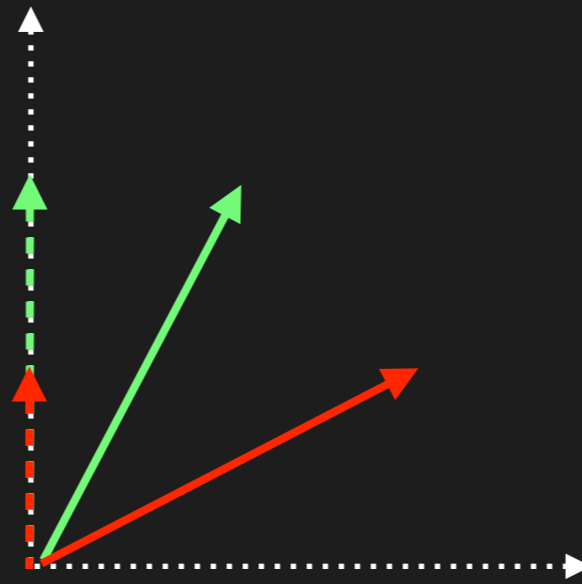
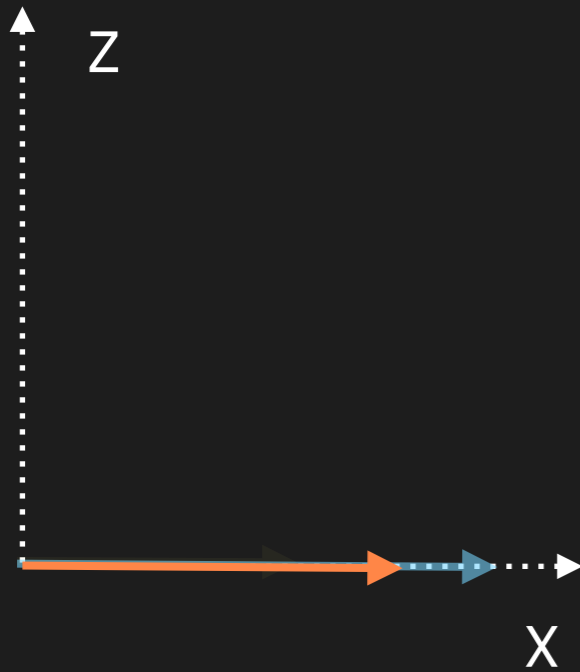

Short T1 more  $M_z$

Long T1 less  $M_z$

Short TR

Large flip angle

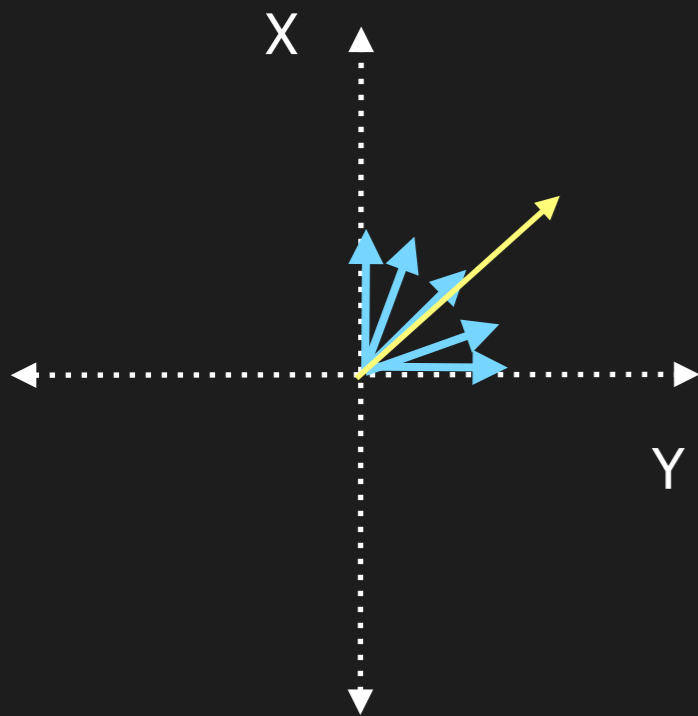

# T1 and T2 weighting

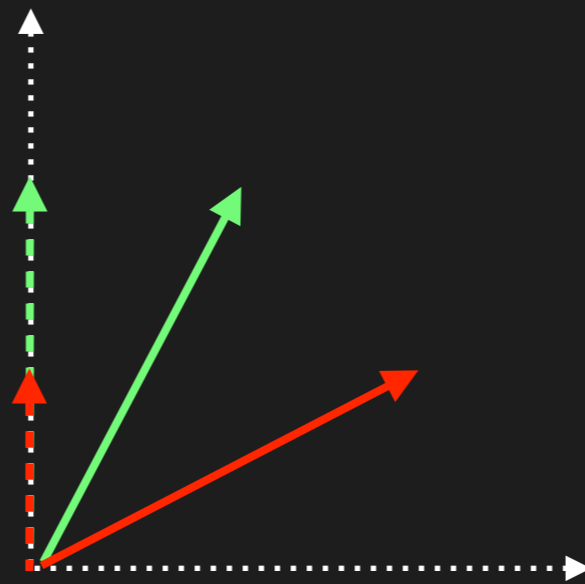
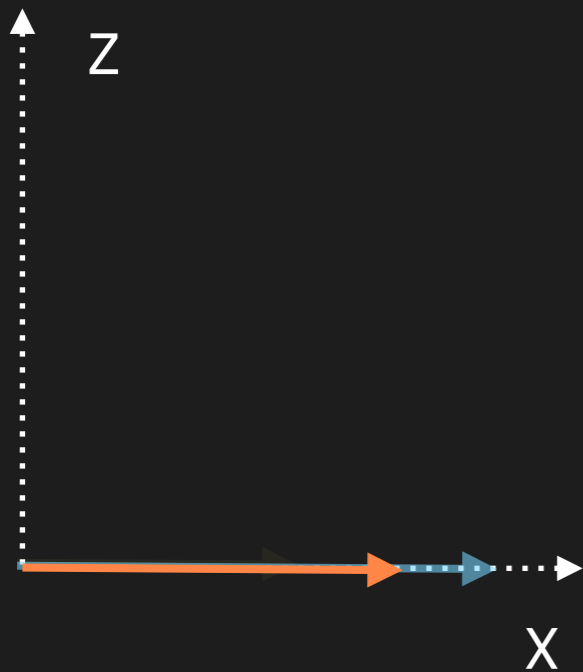

Short T1 more  $M_z$

Long T1 less  $M_z$

Short TR

Large flip angle

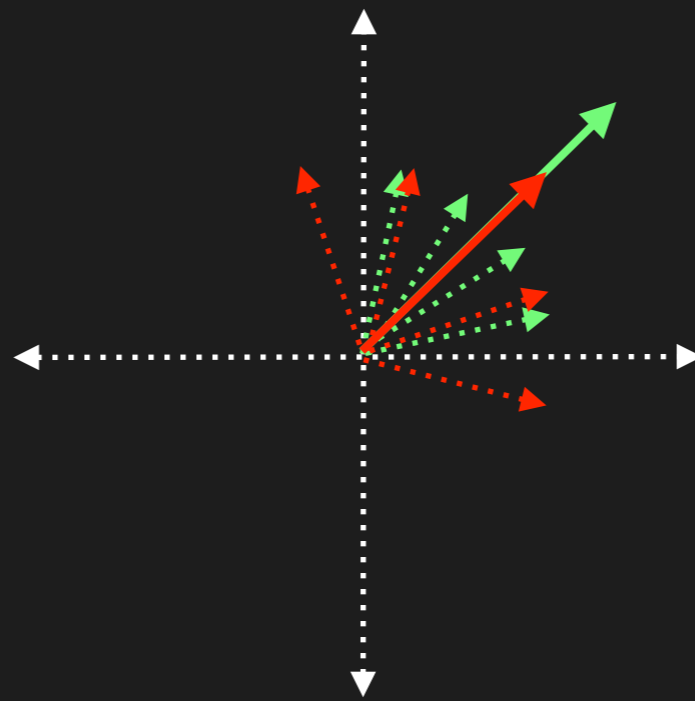
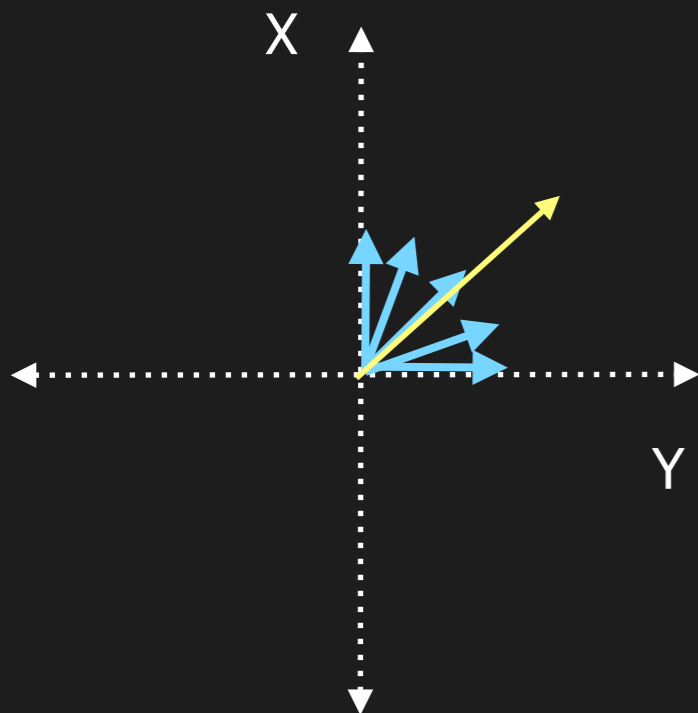

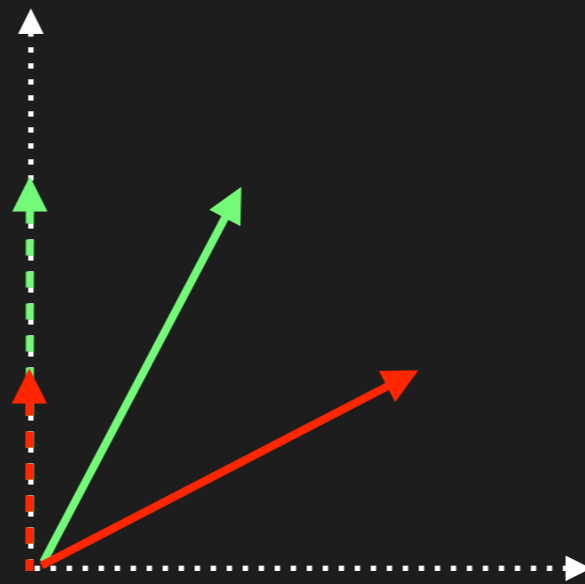
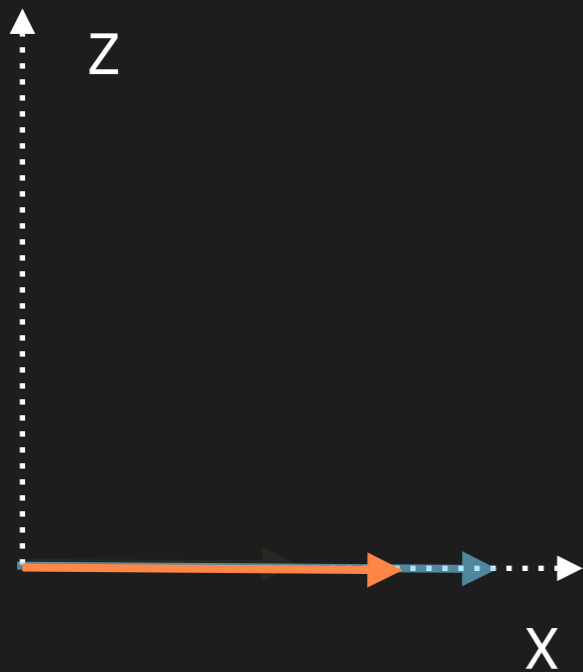

Short T1 more  $M_z$

Long T1 less  $M_z$

Short TR

Large flip angle

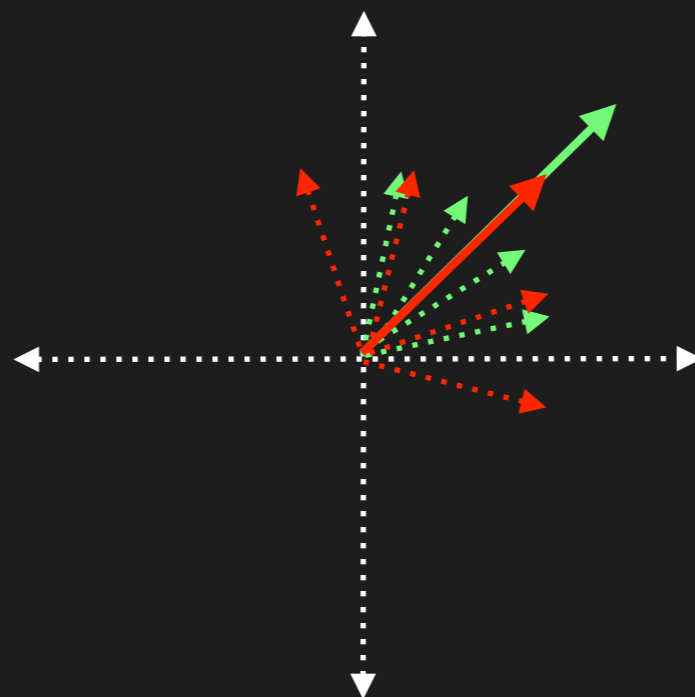
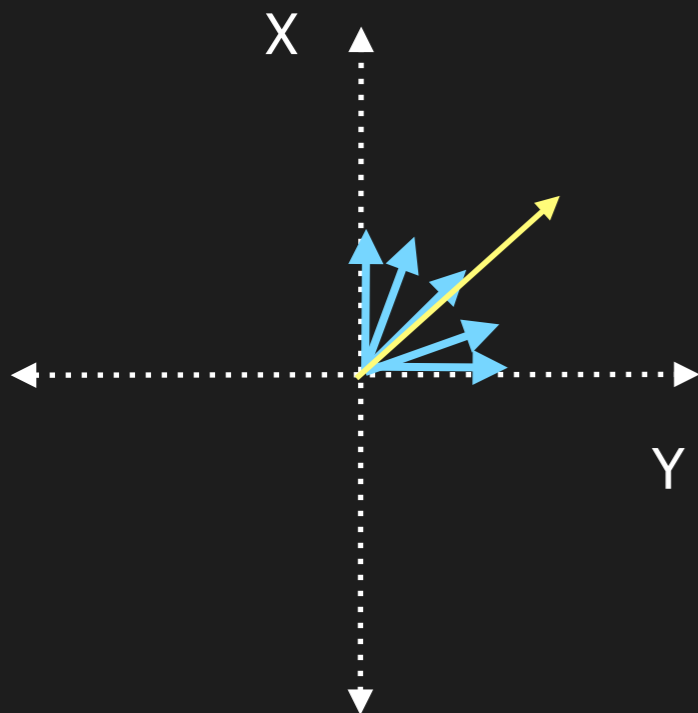

Long T2 more  $M_{xy}$



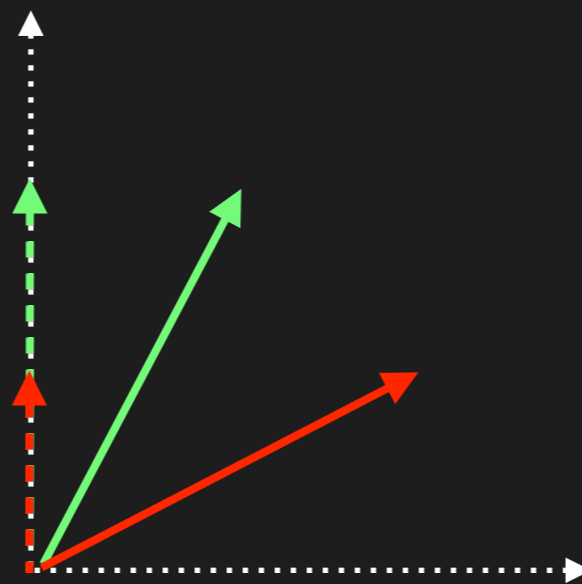
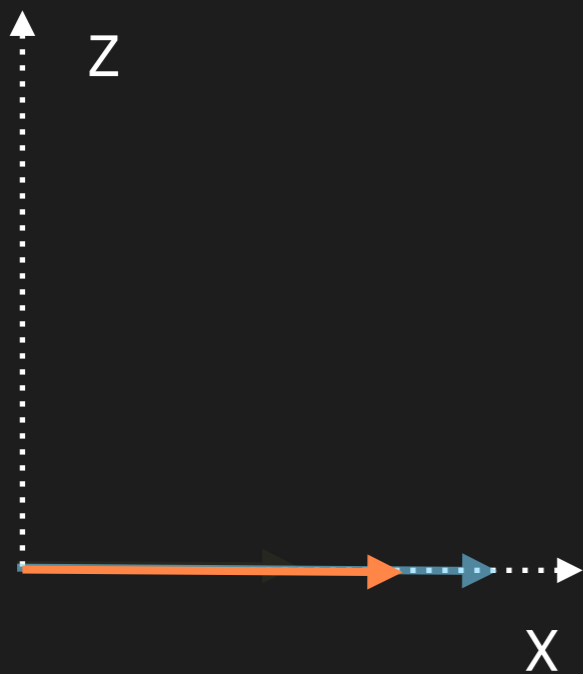

Short T1 more  $M_z$

Long T1 less  $M_z$

Short TR

Large flip angle

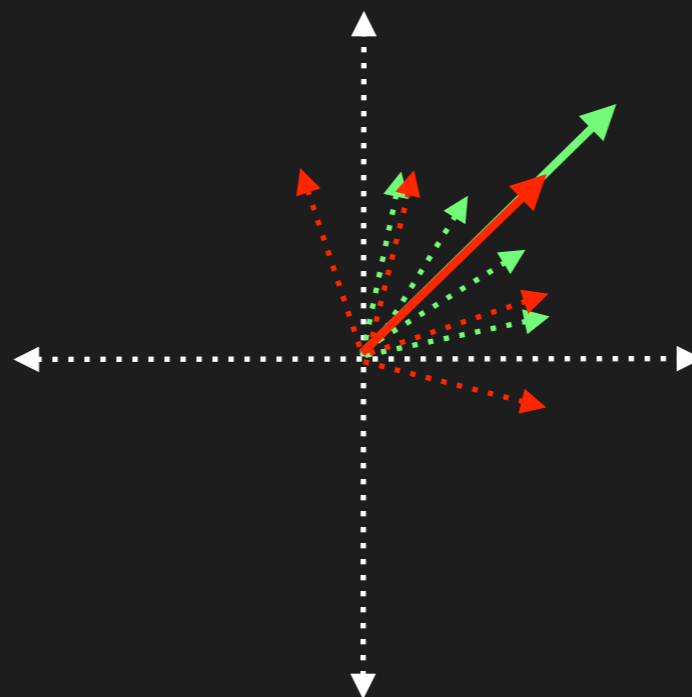
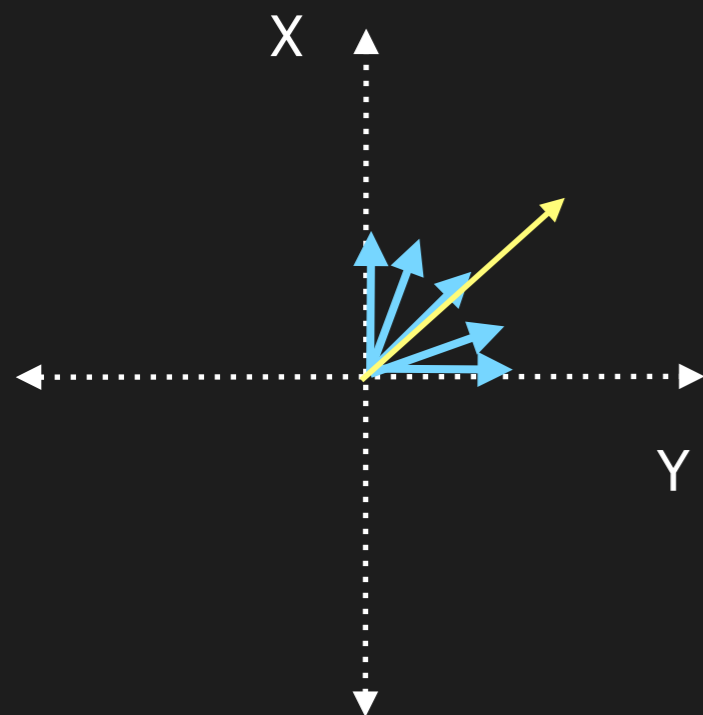

Long T2 more  $M_{xy}$

Short T2 less  $M_{xy}$

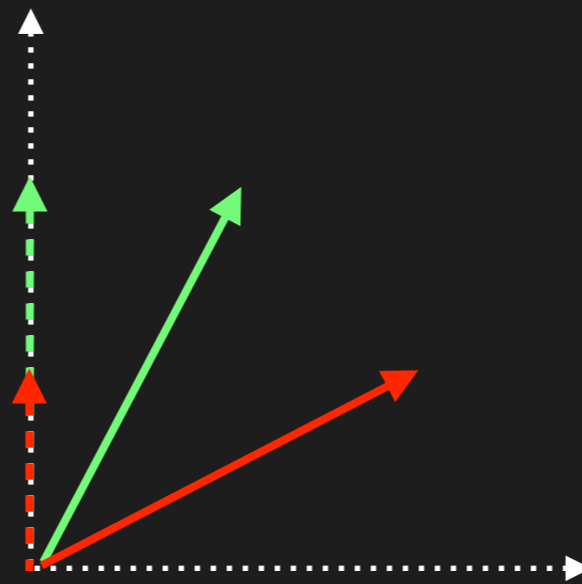
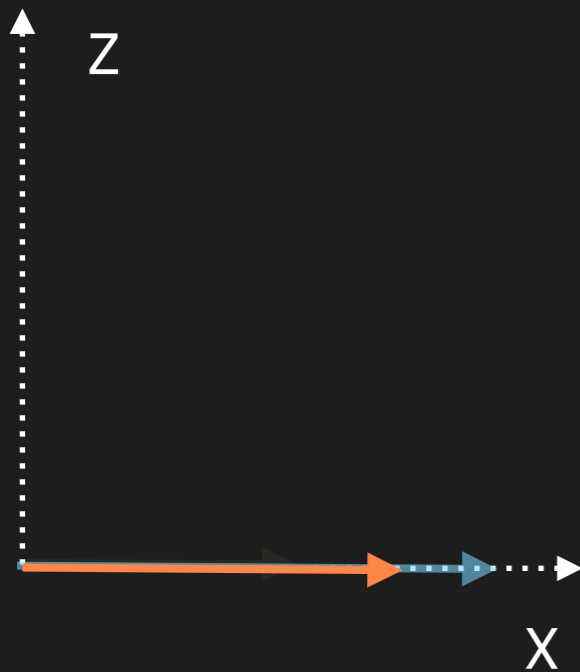

Short T1 more  $M_z$

Long T1 less  $M_z$

Short TR

Large flip angle

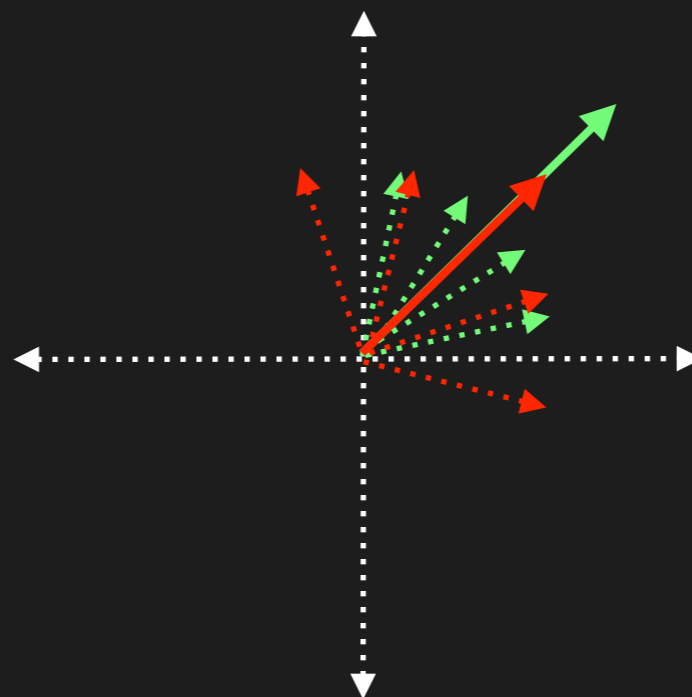
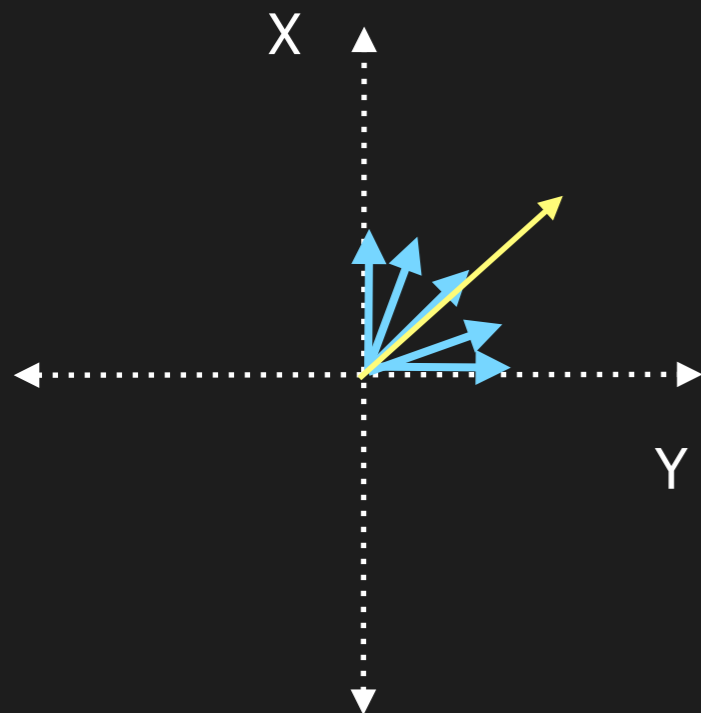

Long T2 more  $M_{xy}$

Short T2 less  $M_{xy}$

Long TE

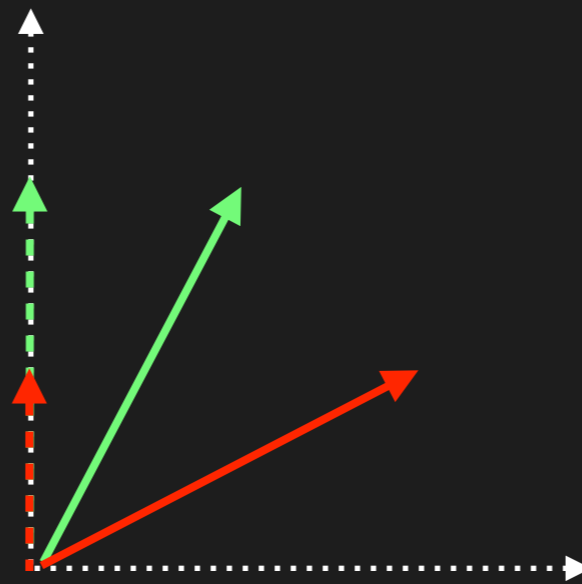
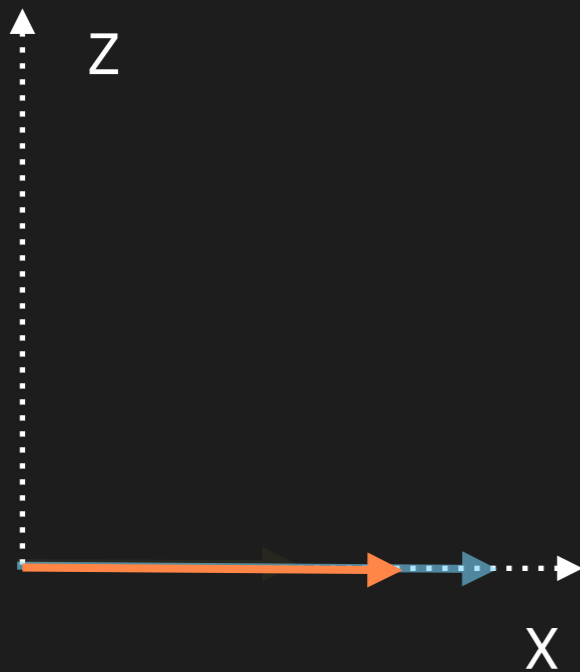

Short T1 more  $M_z$

Long T1 less  $M_z$

Short TR

Large flip angle

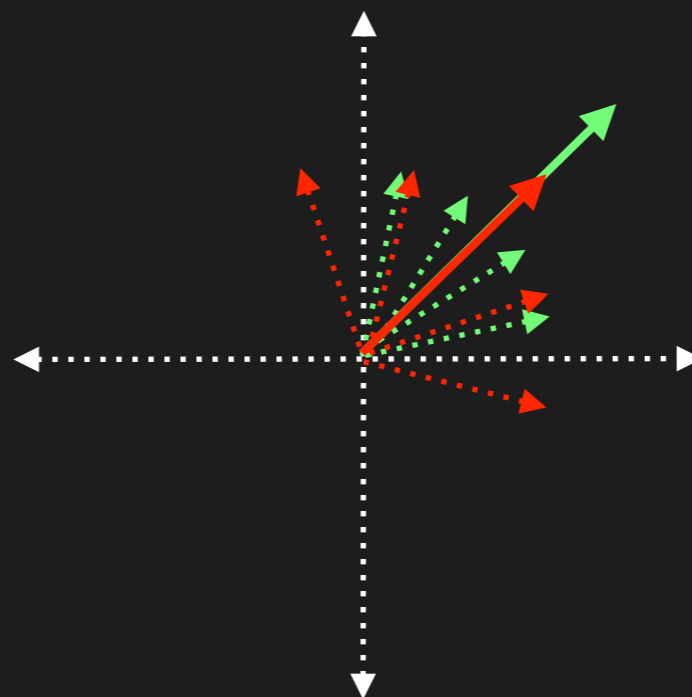
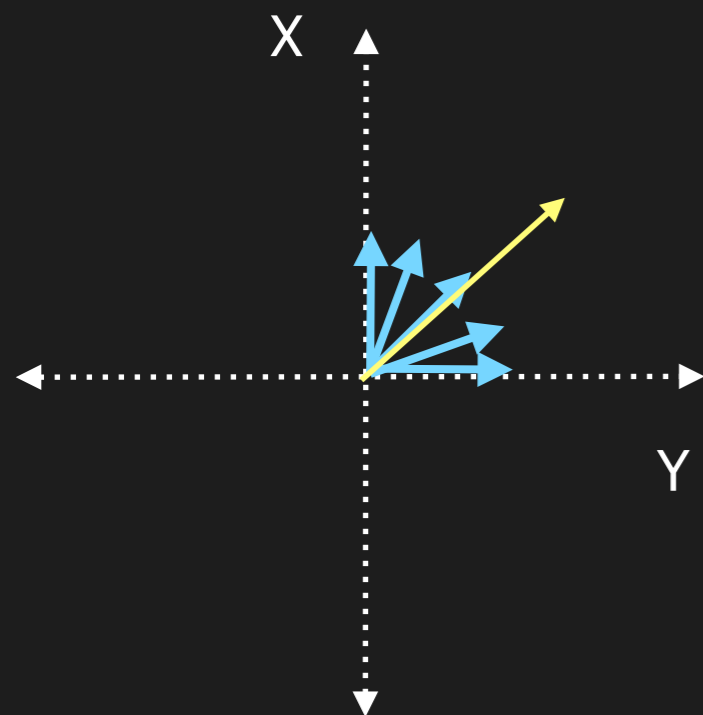

Long T2 more  $M_{xy}$

Short T2 less  $M_{xy}$

Long TE

Long TR

# T1 preparation schemes

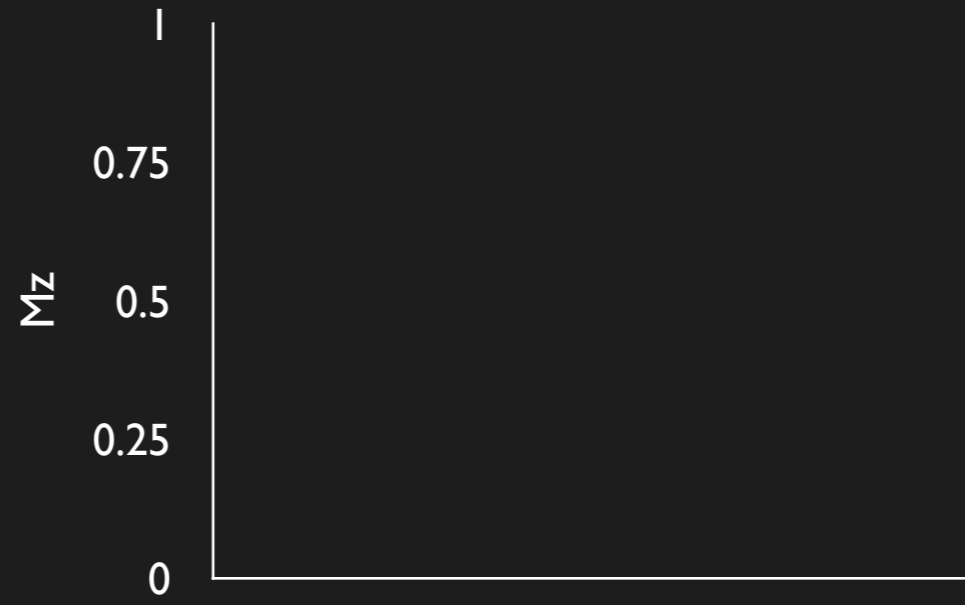
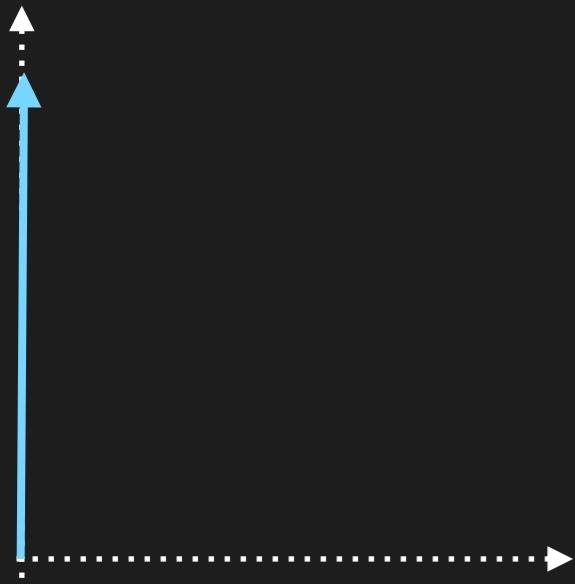

# T1 preparation schemes



# T1 preparation schemes

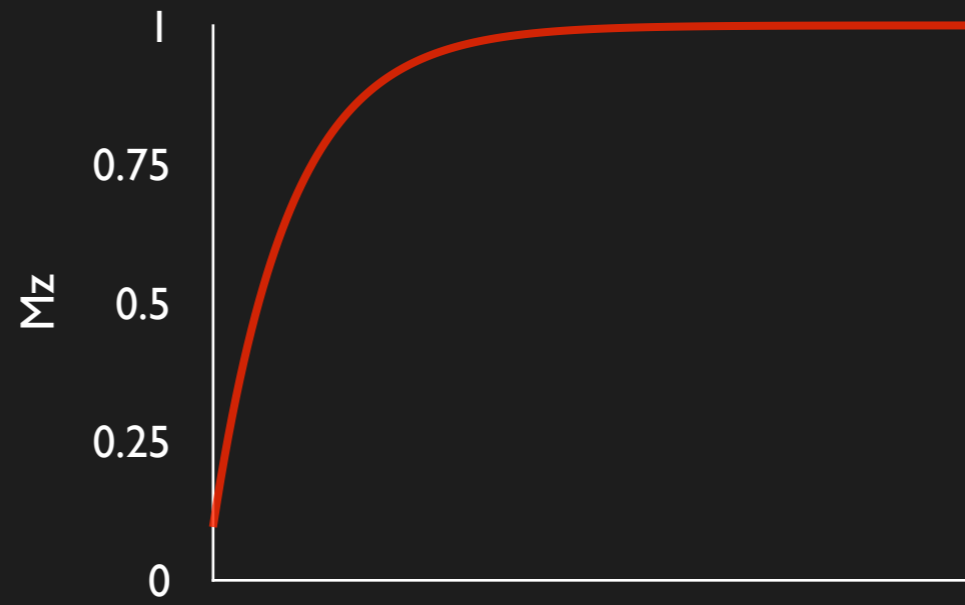
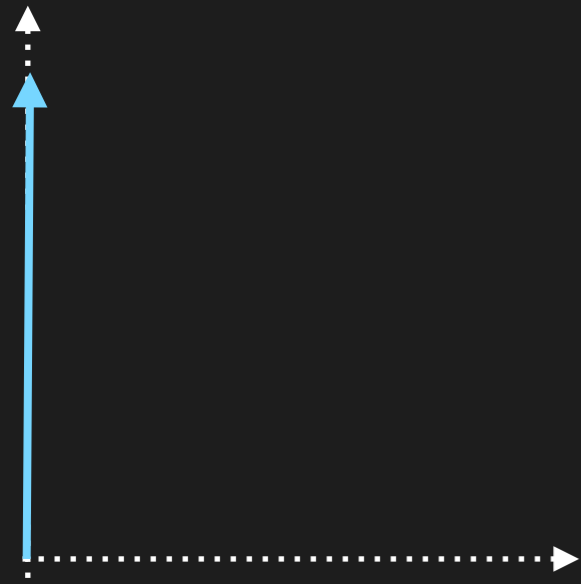

**Short T1**

# T1 preparation schemes

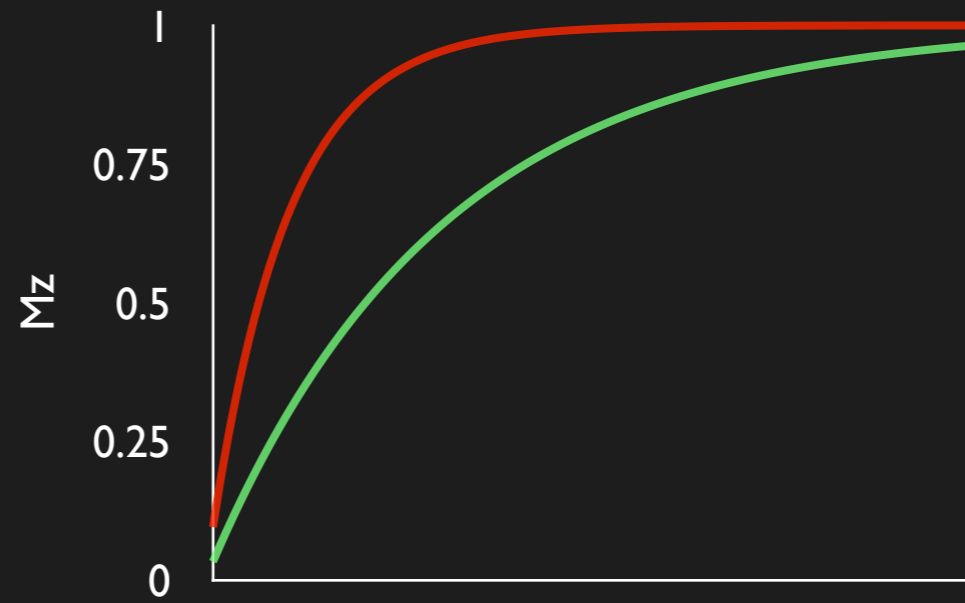
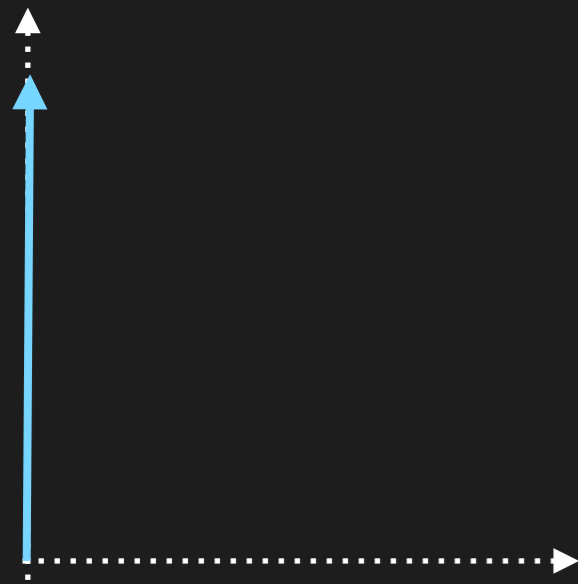

Short T1

Long T1

# T1 preparation schemes

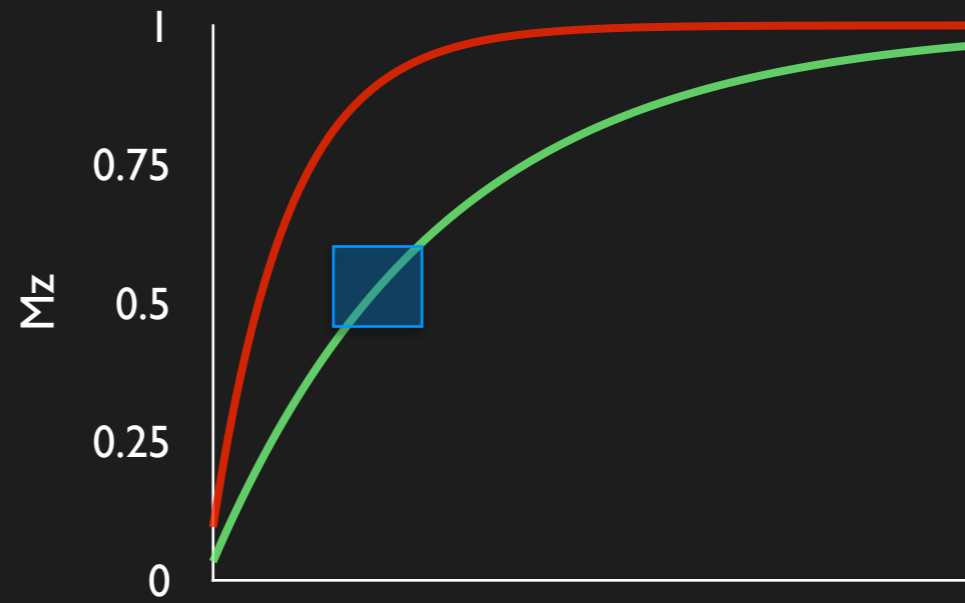
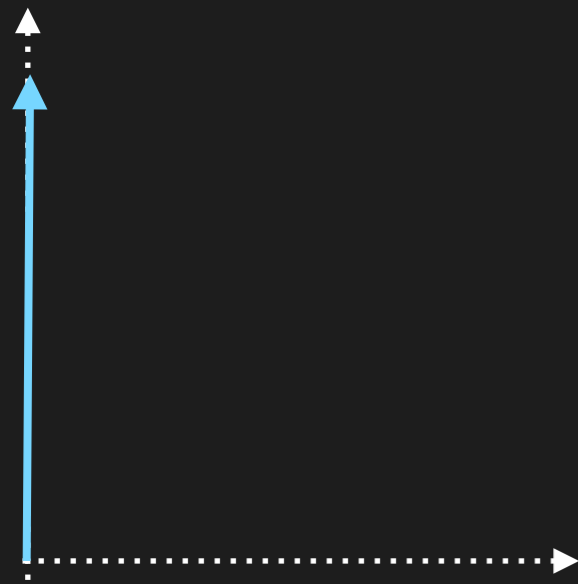

**Short T1**

**Long T1**

**T1 dependant imaging**



# T1 preparation schemes

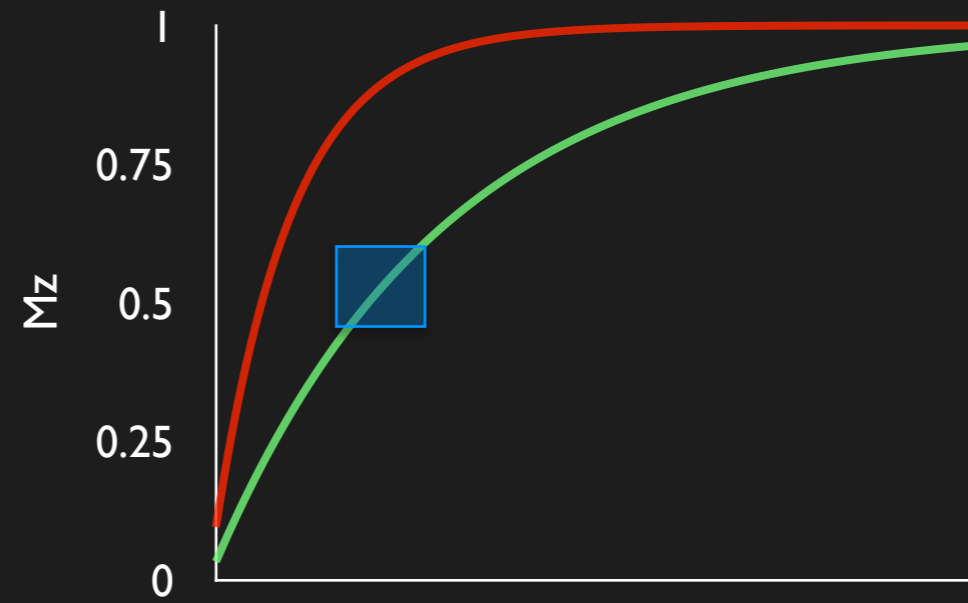
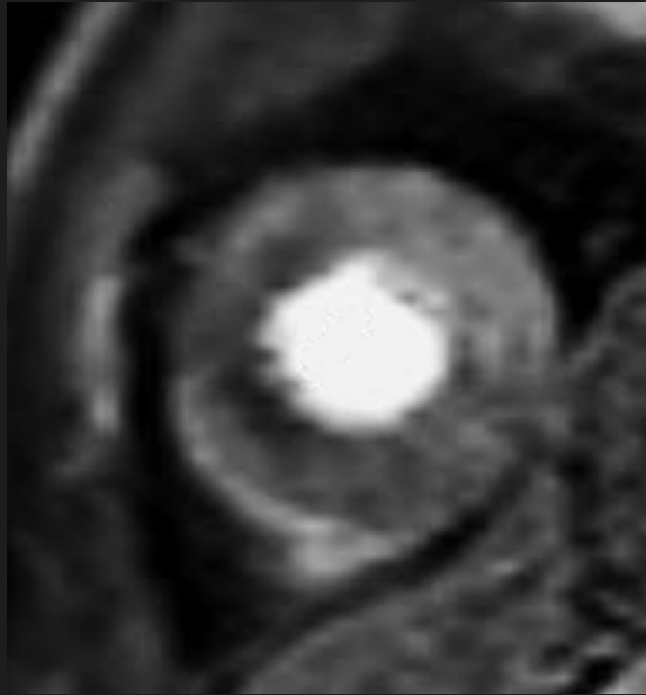

Short T1

Long T1

T1 dependant imaging

# T1 preparation schemes

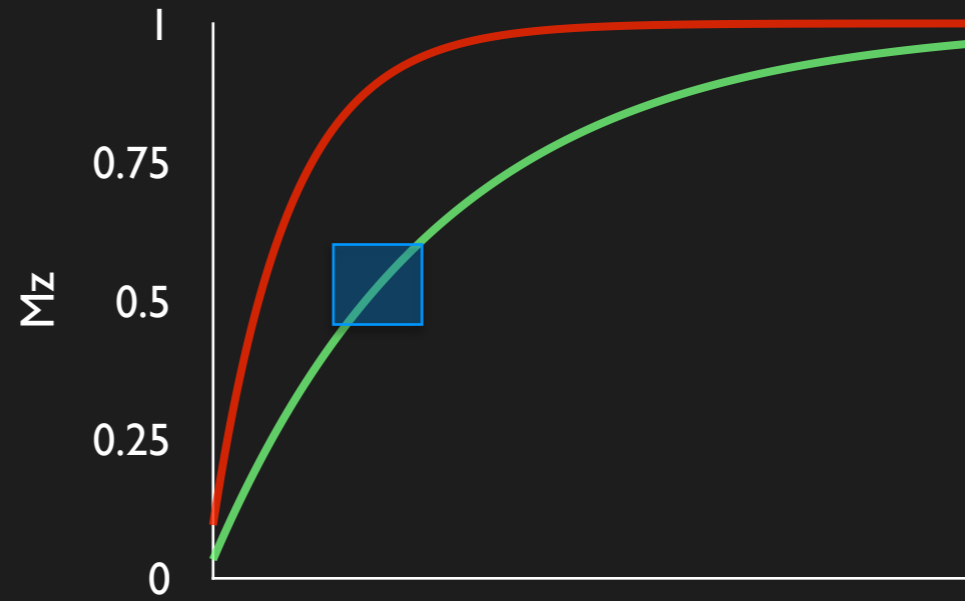
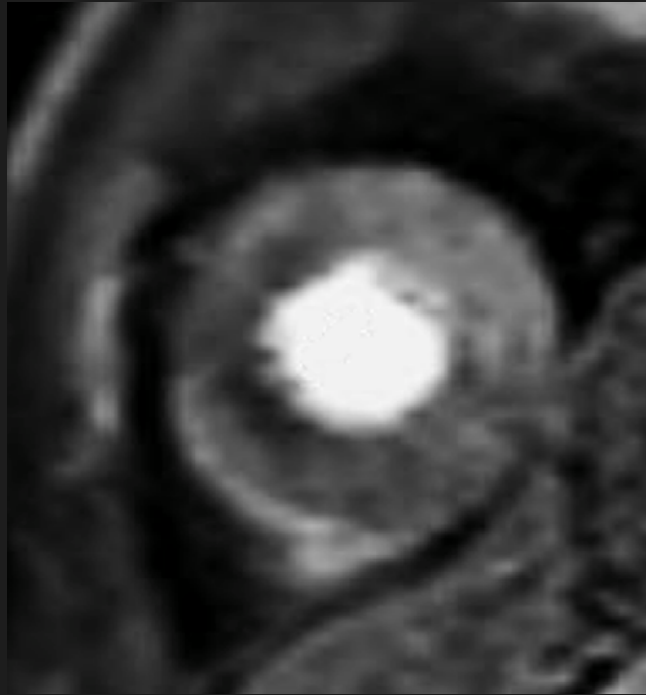

Short T1

Long T1

T1 dependant imaging

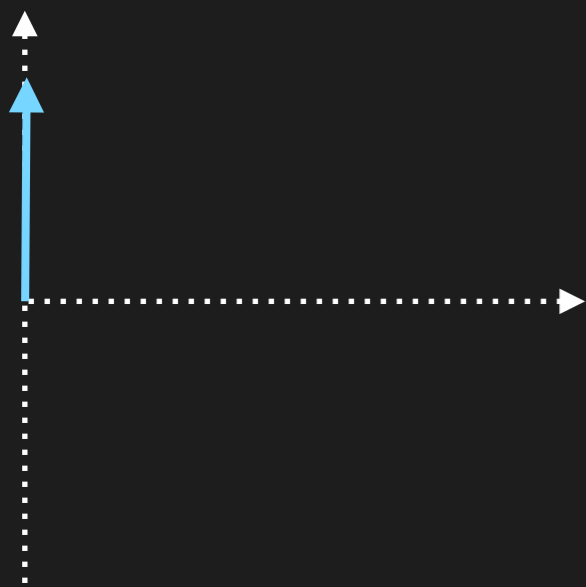

# T1 preparation schemes

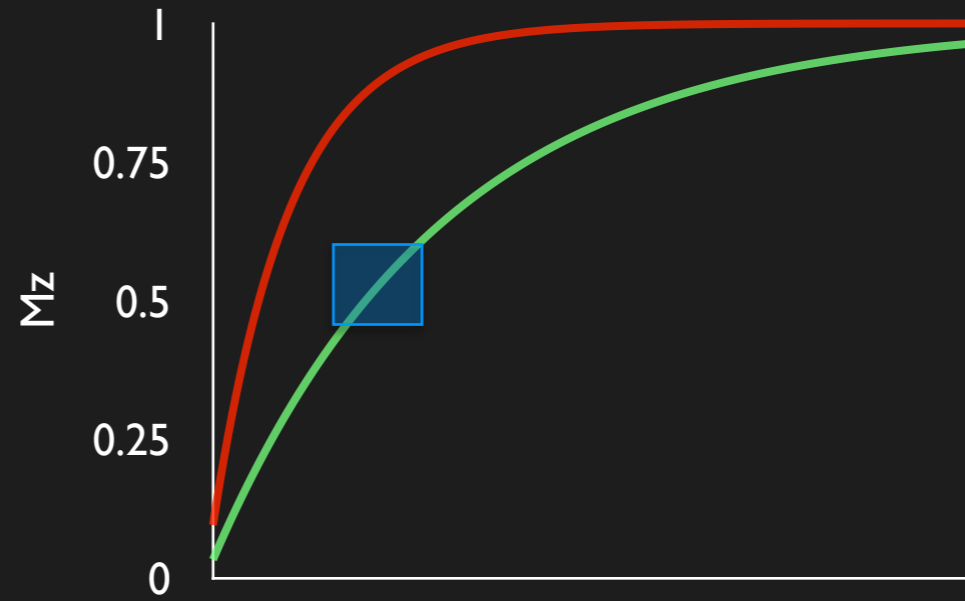
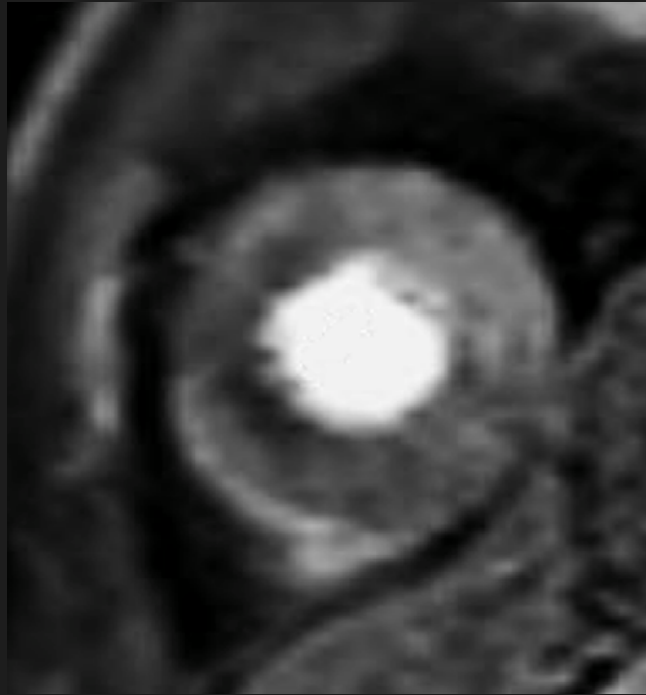

Short T1

Long T1

T1 dependant imaging

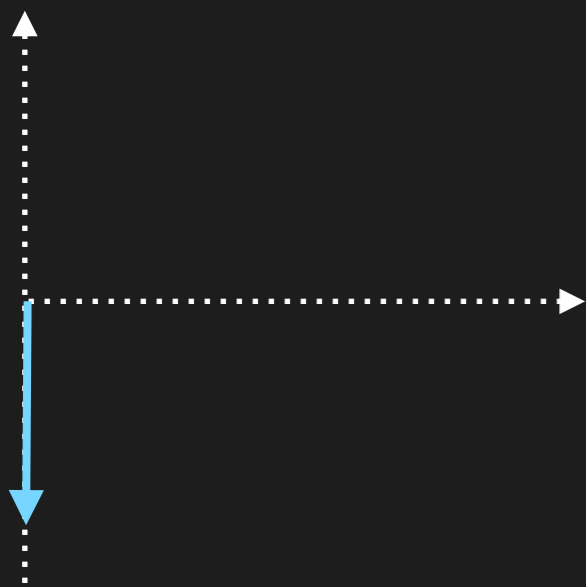

# T1 preparation schemes

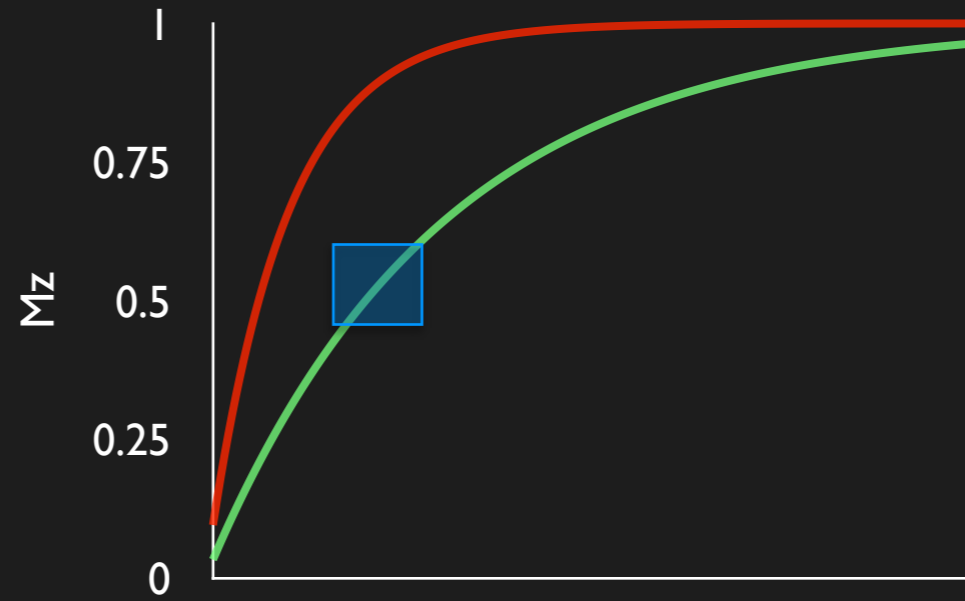
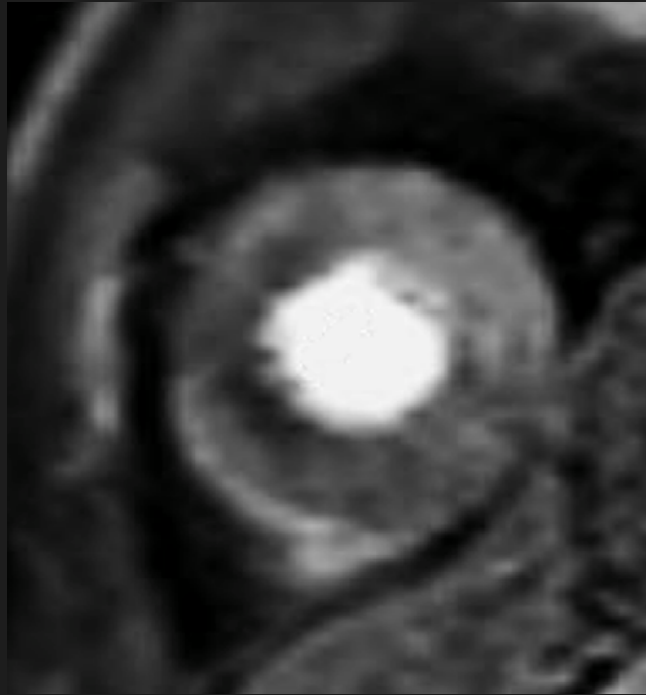

Short T1

Long T1

T1 dependant imaging

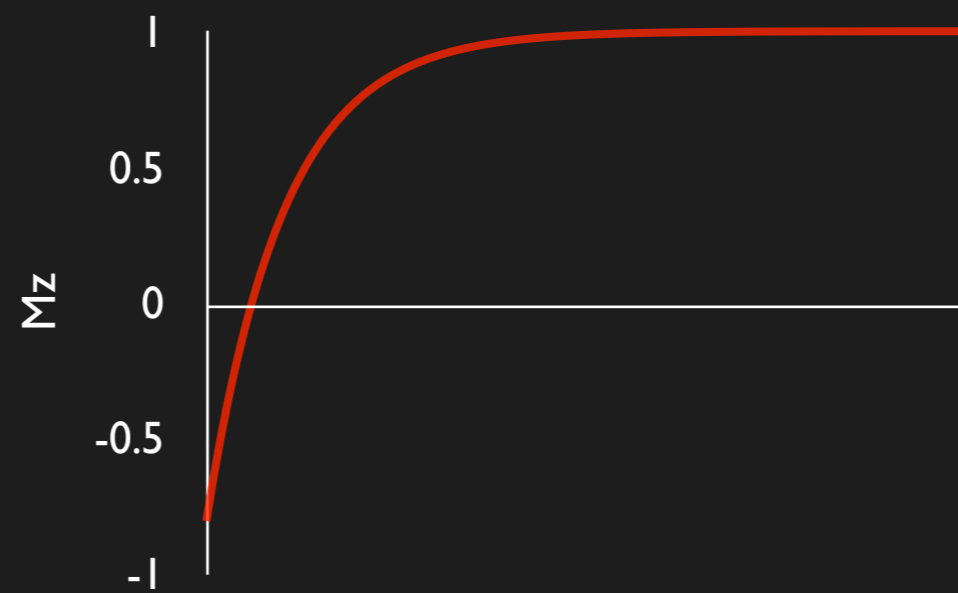
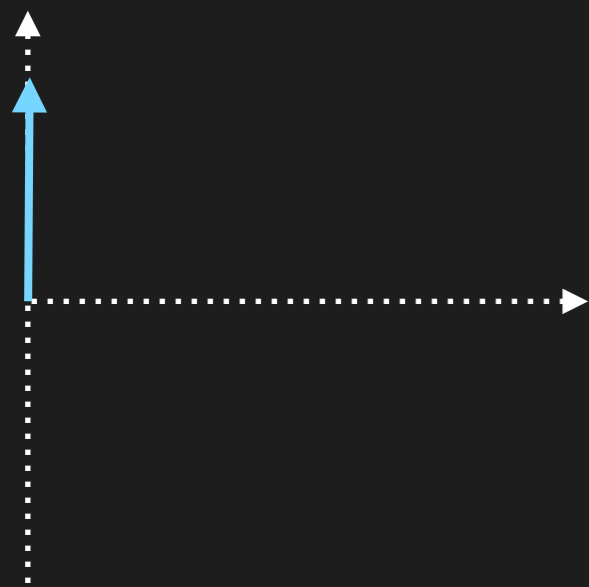

Null point at  $0.693 \cdot T_1$

# T1 preparation schemes

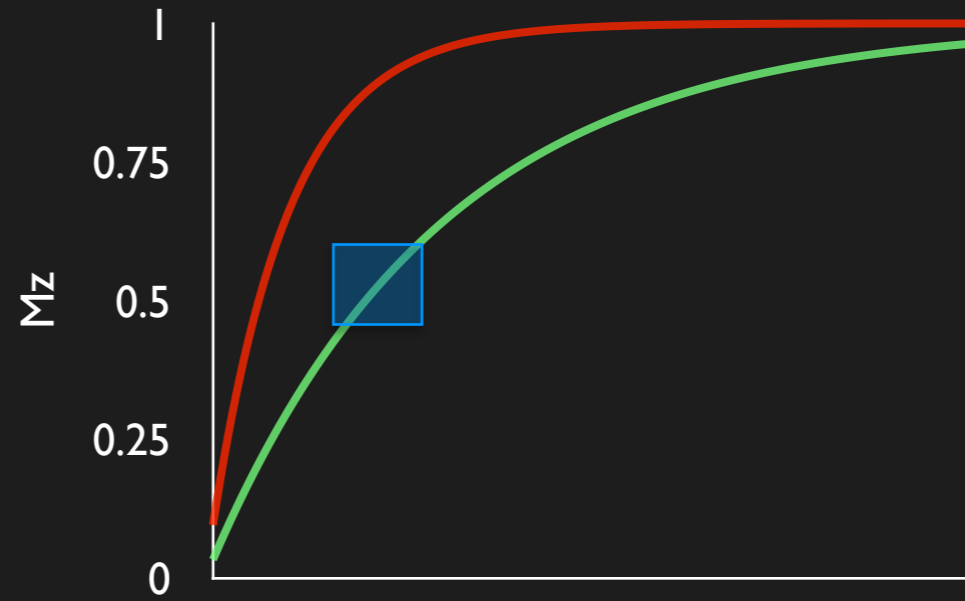
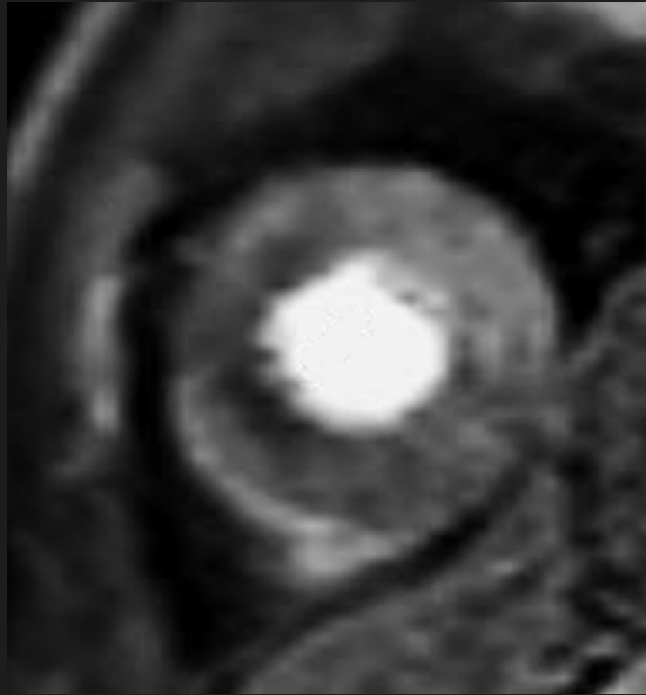

Short T1

Long T1

T1 dependant imaging

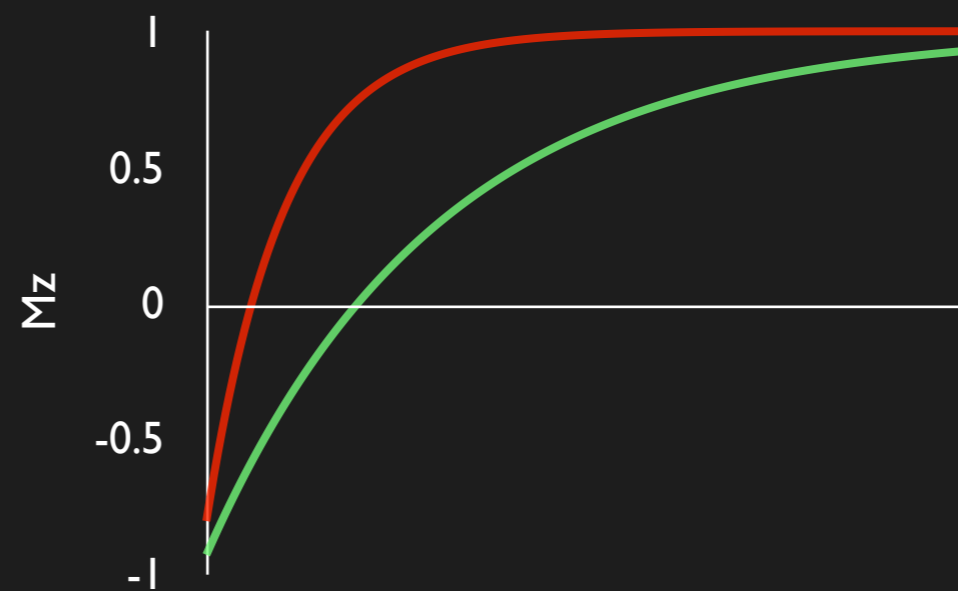
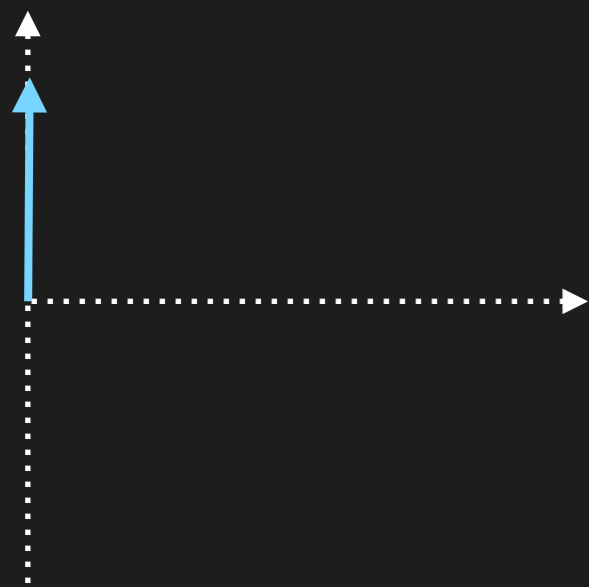

Null point at  $0.693 \cdot T1$

Longer T1

# T1 preparation schemes

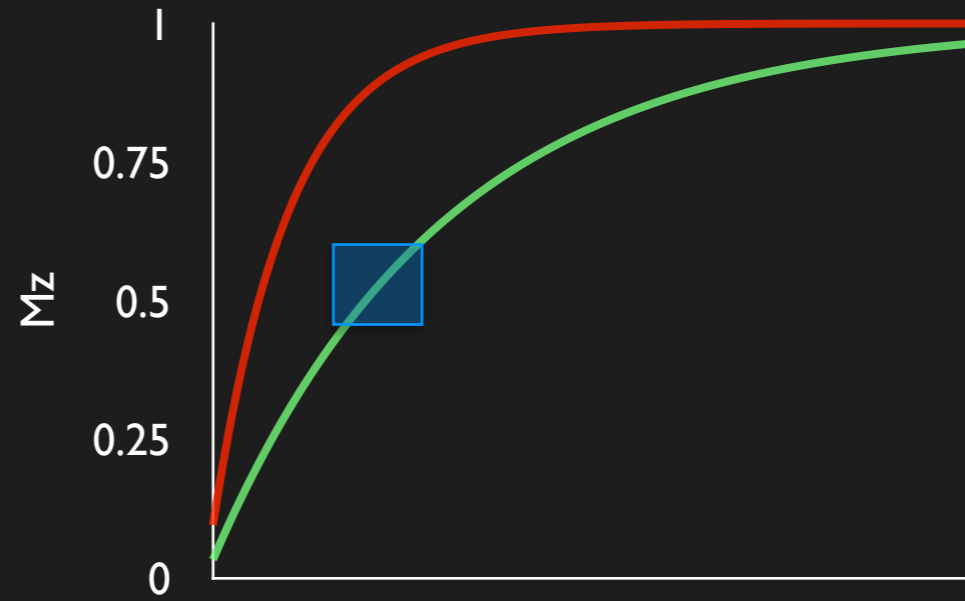
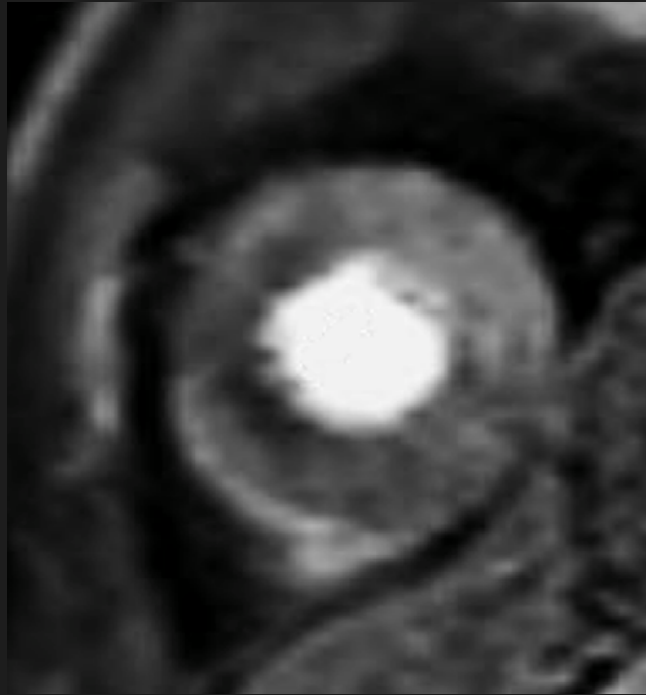

Short  $T_1$

Long  $T_1$

T1 dependant imaging

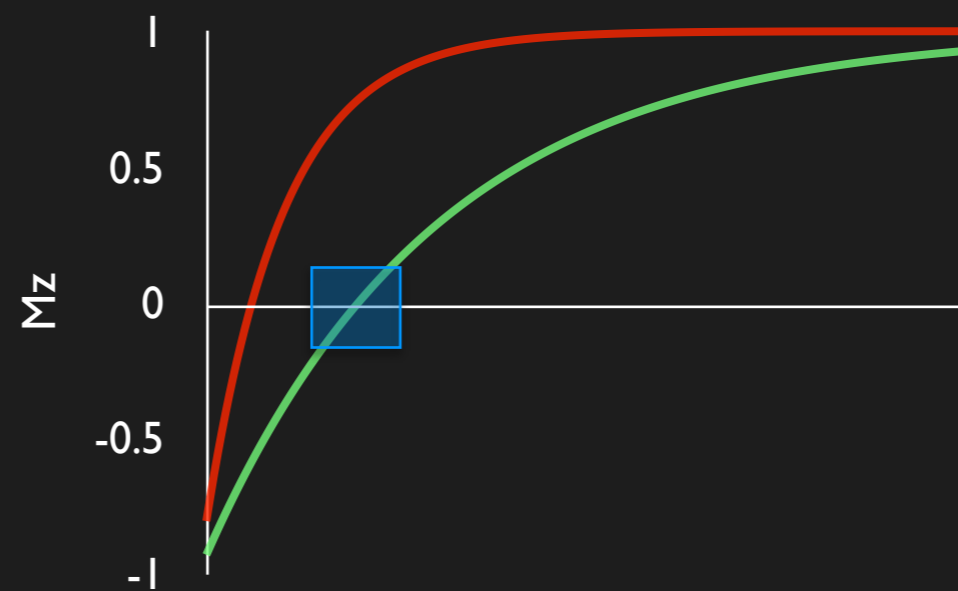
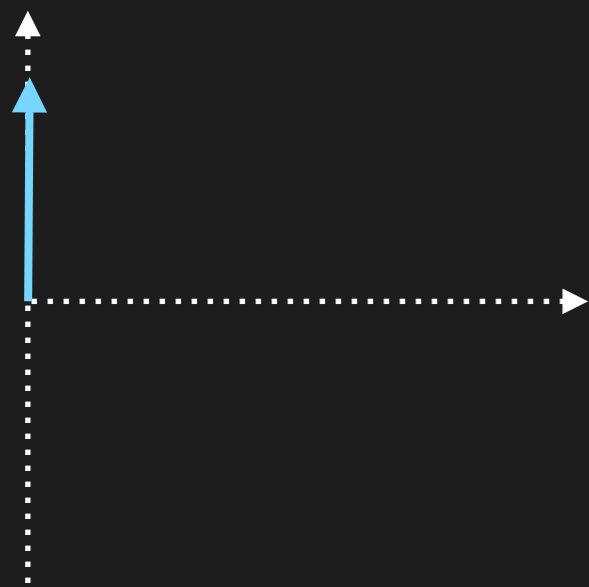

Null point at  $0.693 \cdot T_1$

Longer  $T_1$

High contrast

# T1 preparation schemes

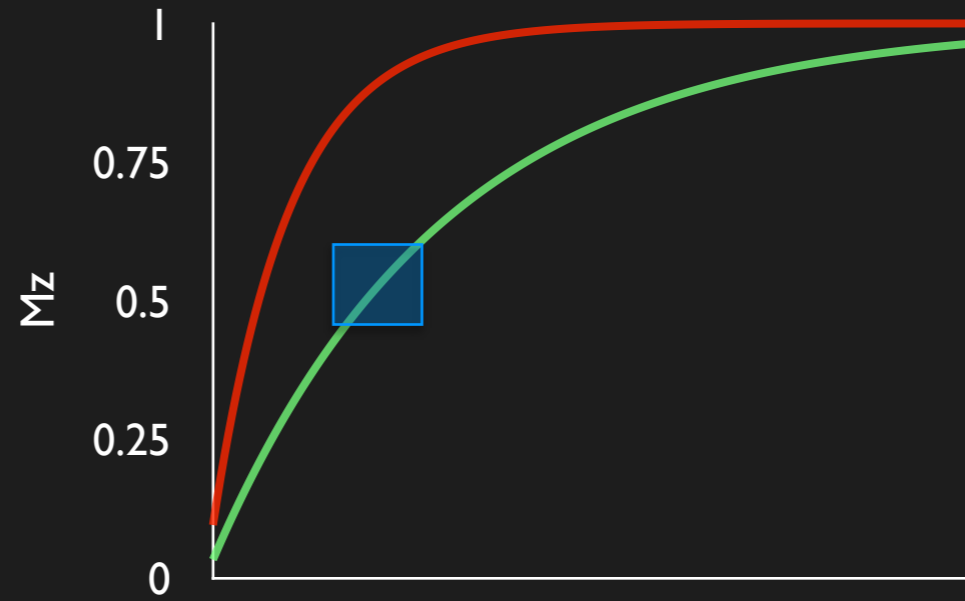
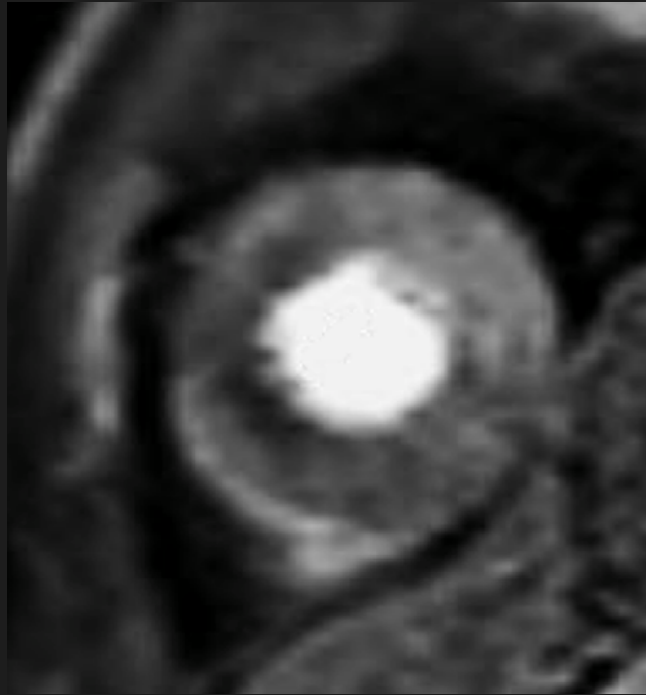

Short T1

Long T1

T1 dependant imaging

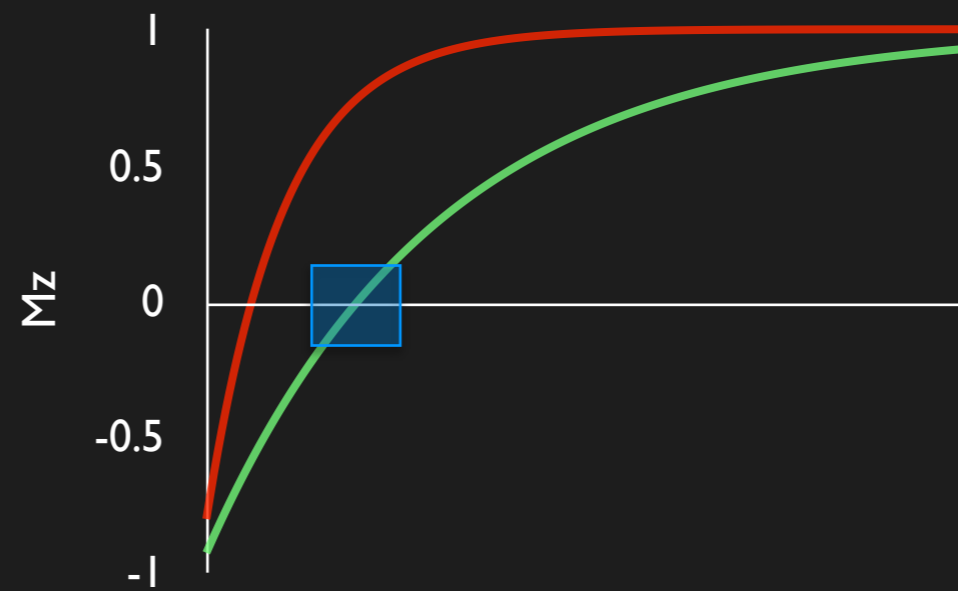
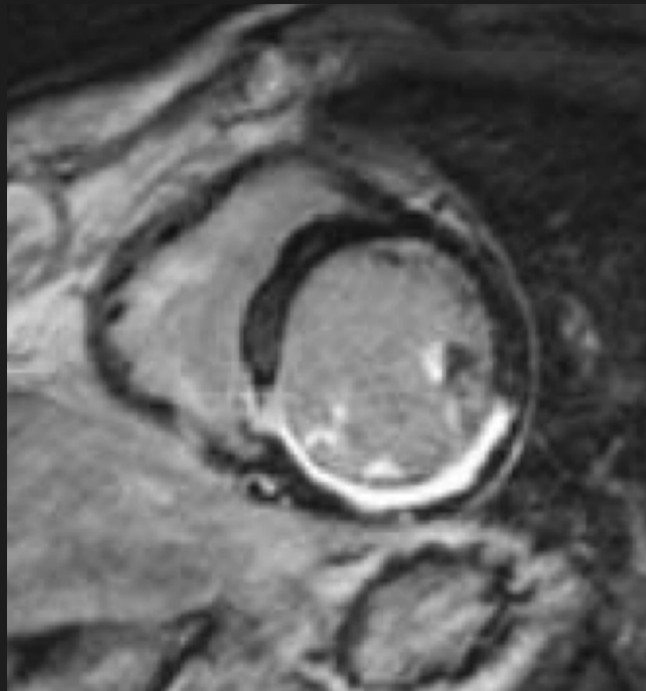

Null point at  $0.693 \cdot T1$

Longer T1

High contrast

Static

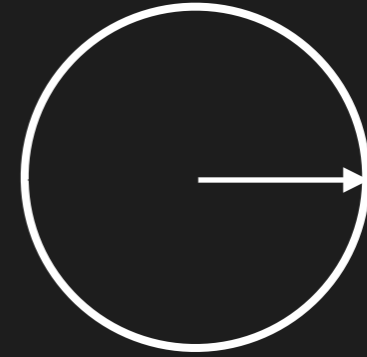
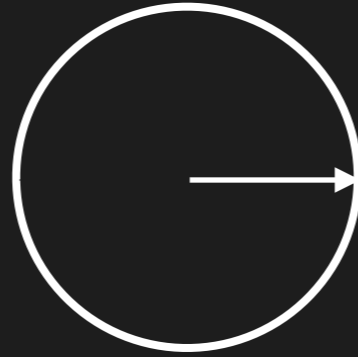
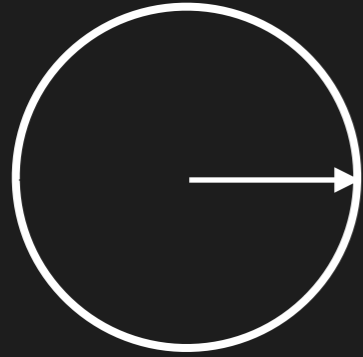



Static

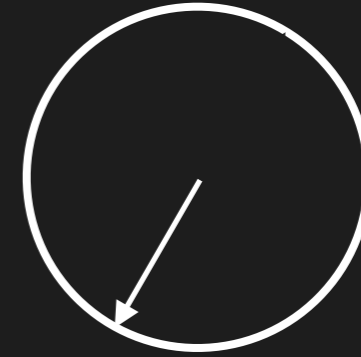
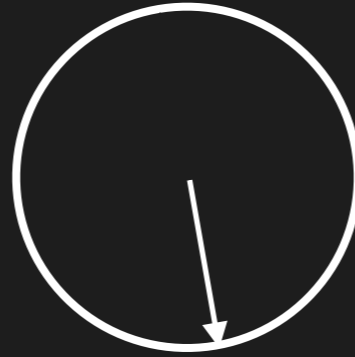

G+



Static

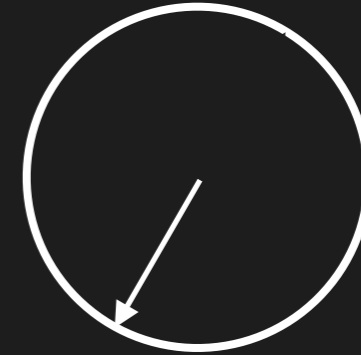
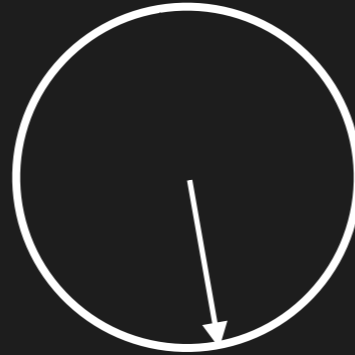

Moving

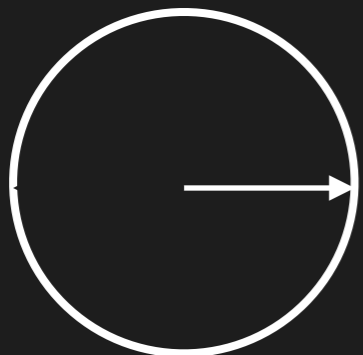

G+



Static

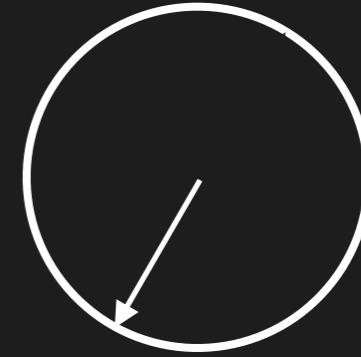
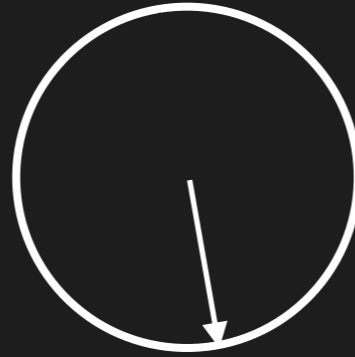

Moving

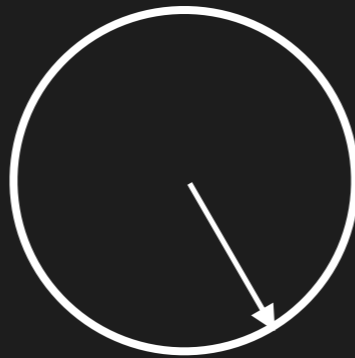

G+



Static

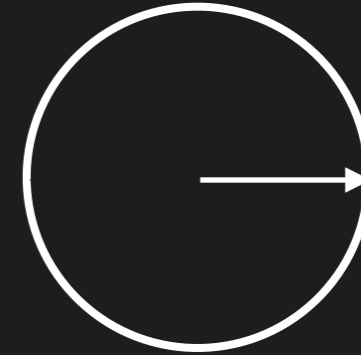
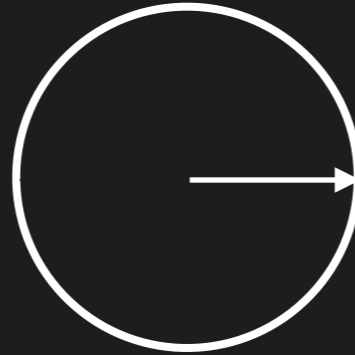
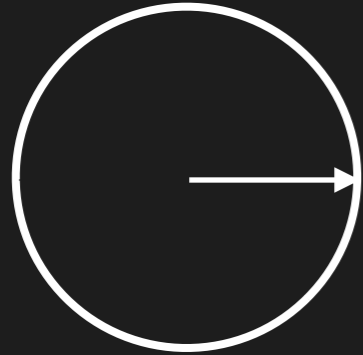

Moving



G+

G-

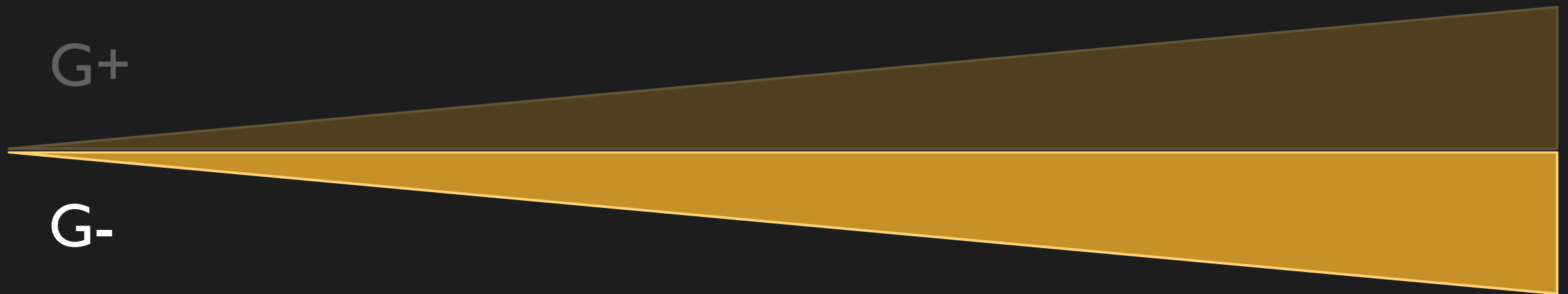

Static

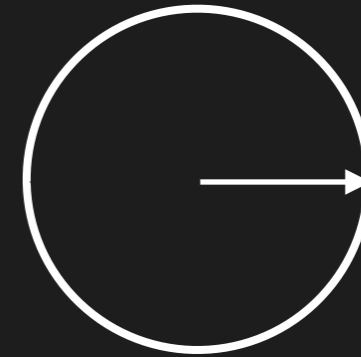
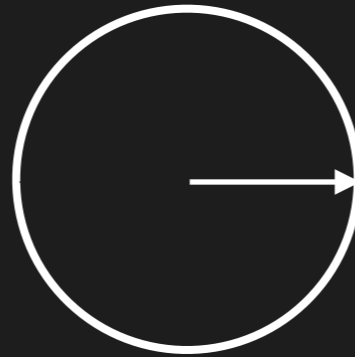
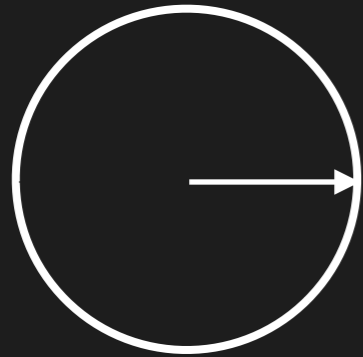

Moving

$$\phi \propto V$$

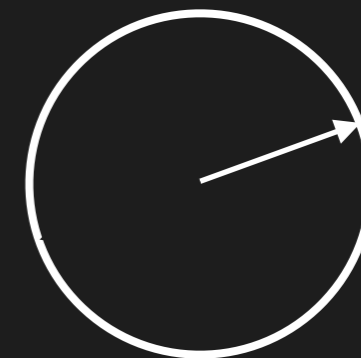

G+

G-

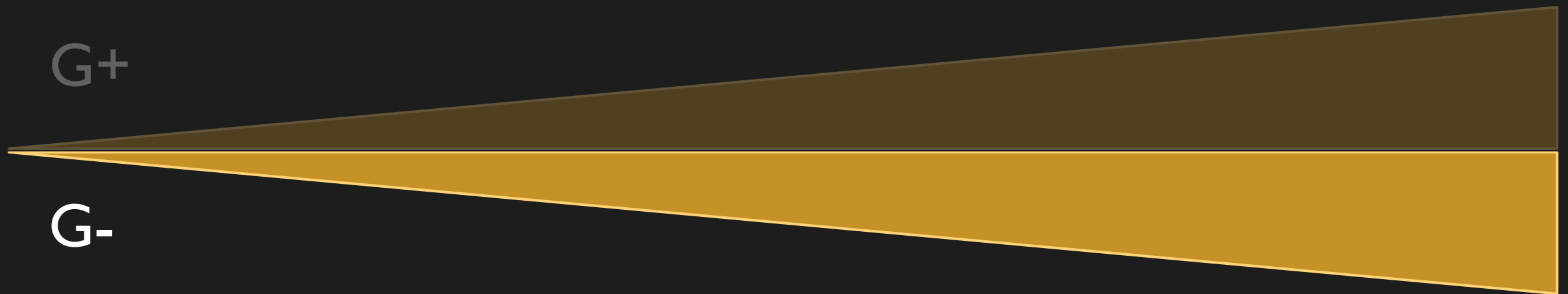

## Spoiled gradient echo sequence

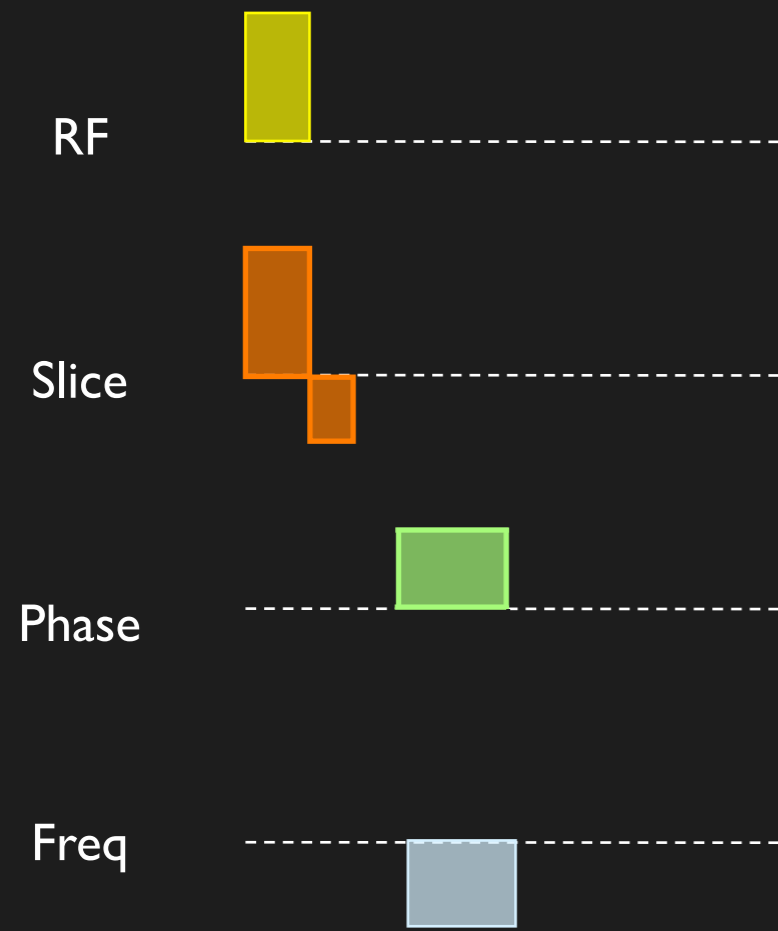

## Spoiled gradient echo sequence

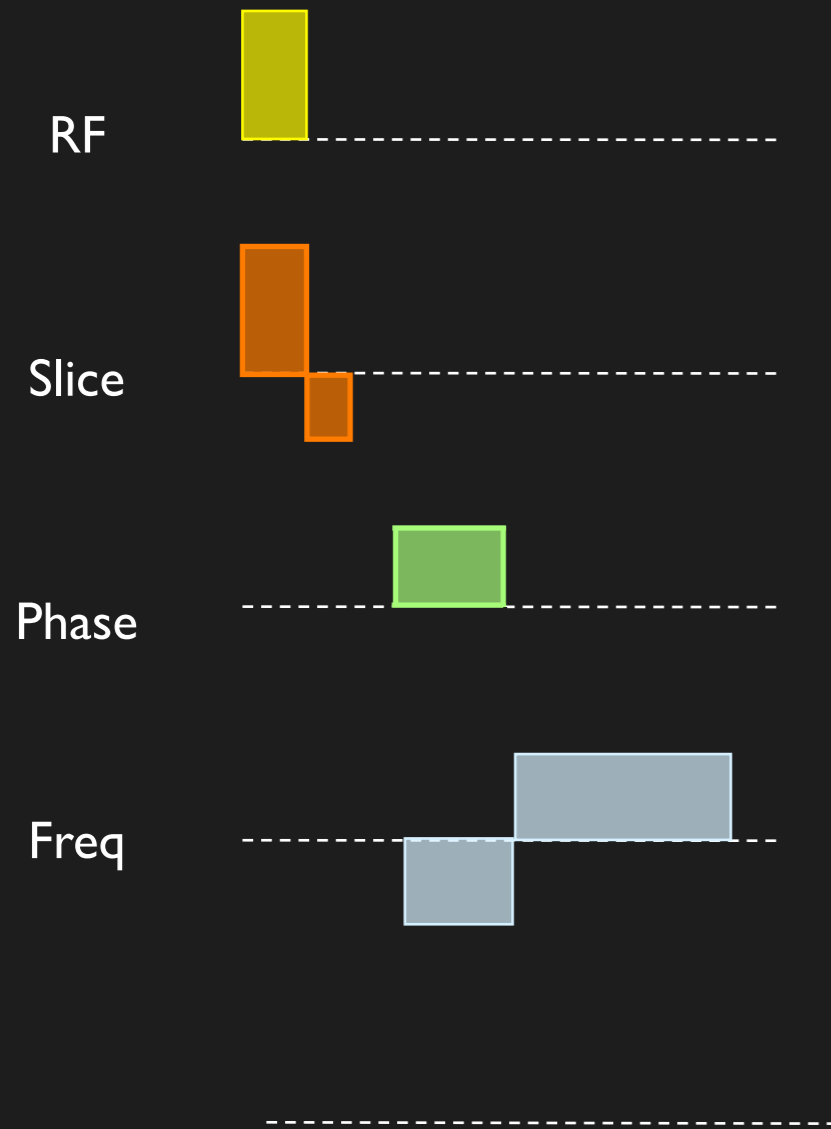

**k-space**

## Spoiled gradient echo sequence

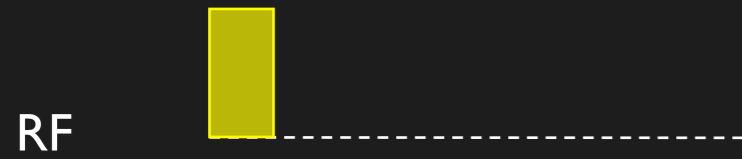

k-space





## Spoiled gradient echo sequence

## Magnitude



RF



Slice



Phase

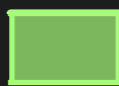

Freq



**k-space**



## Spoiled gradient echo sequence

## Magnitude



## Phase

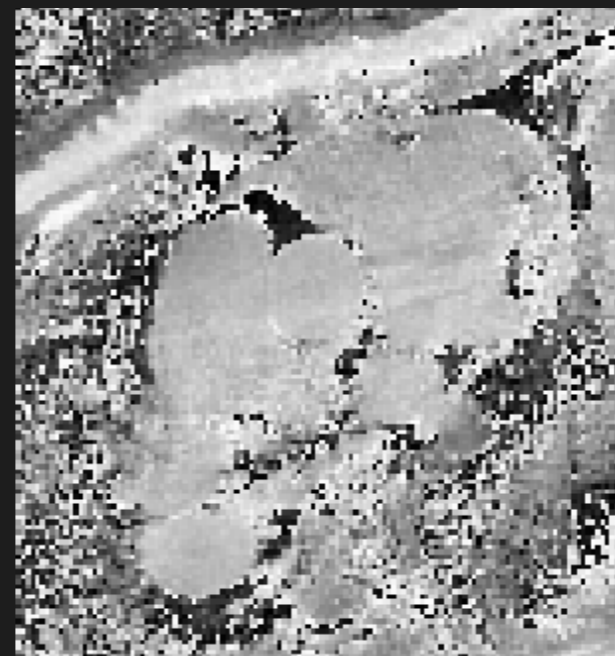

RF



Slice



Phase

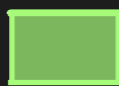

Freq



k-space



## Spoiled gradient echo sequence

## Magnitude

## Magnitude

## Phase

## Phase

RF

Slice

Phase

Freq

k-space

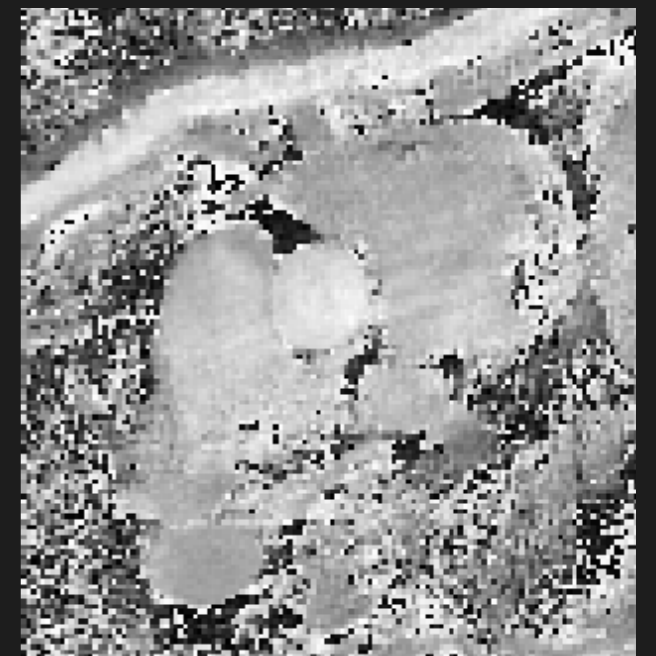
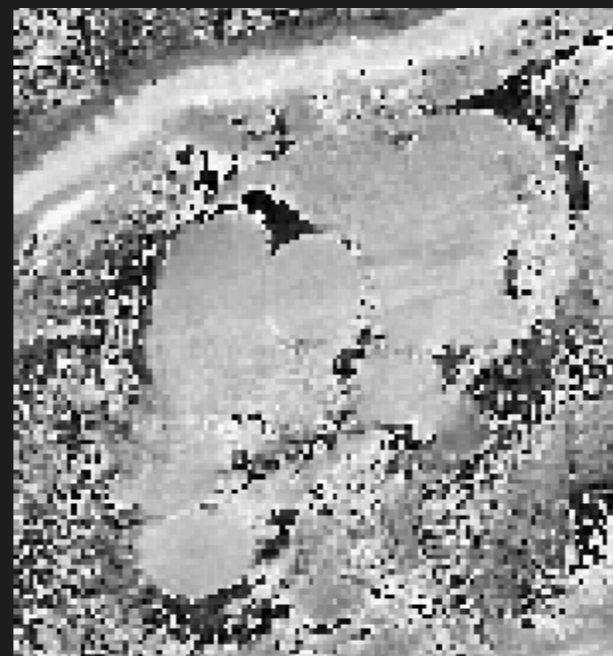
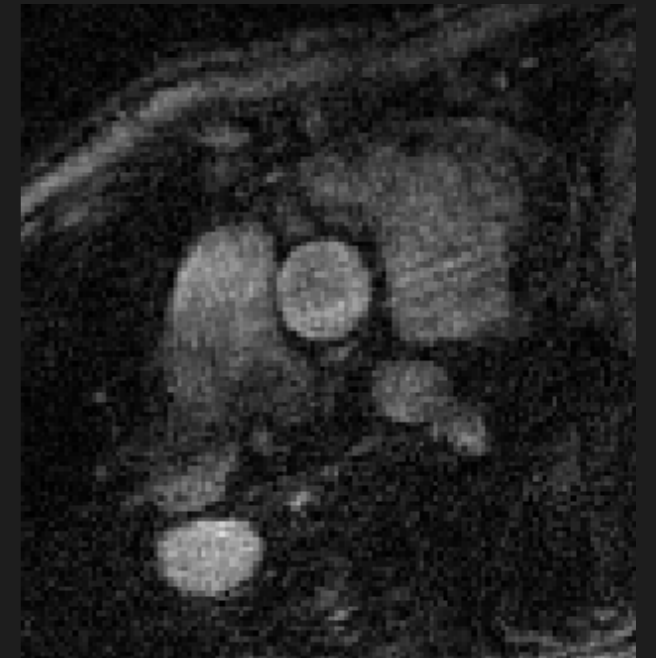
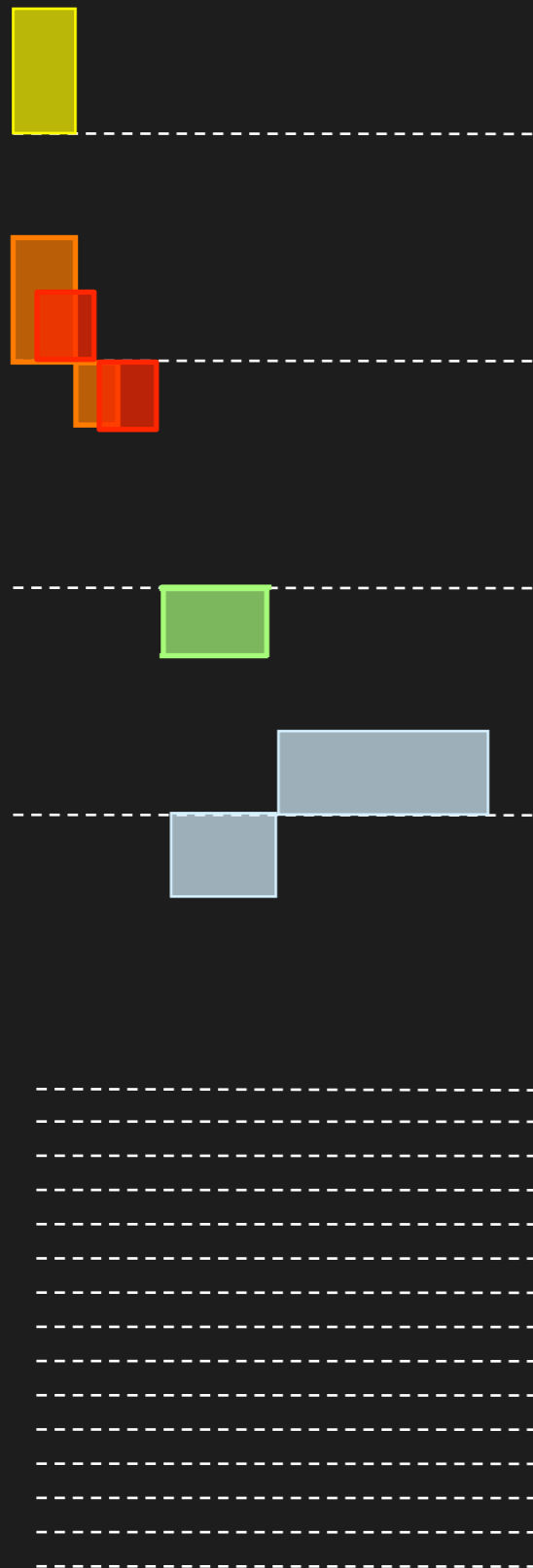

## Spoiled gradient echo sequence

## Magnitude

## Magnitude

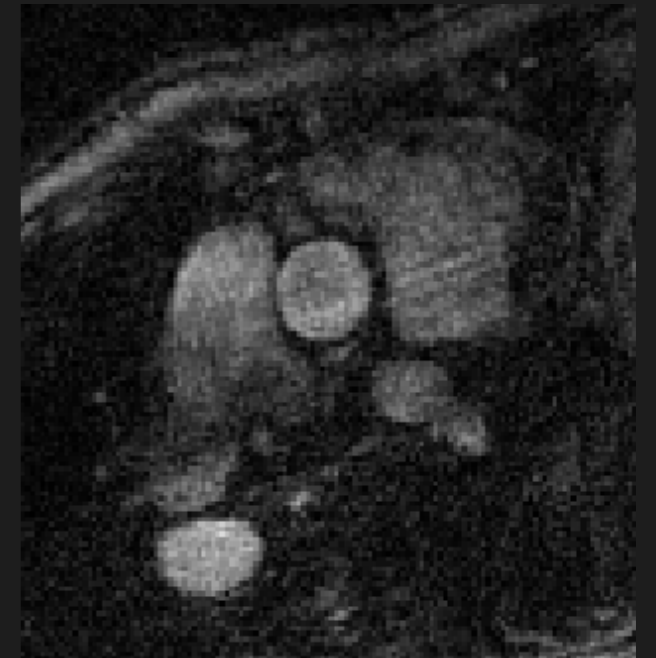

## Phase

## Phase

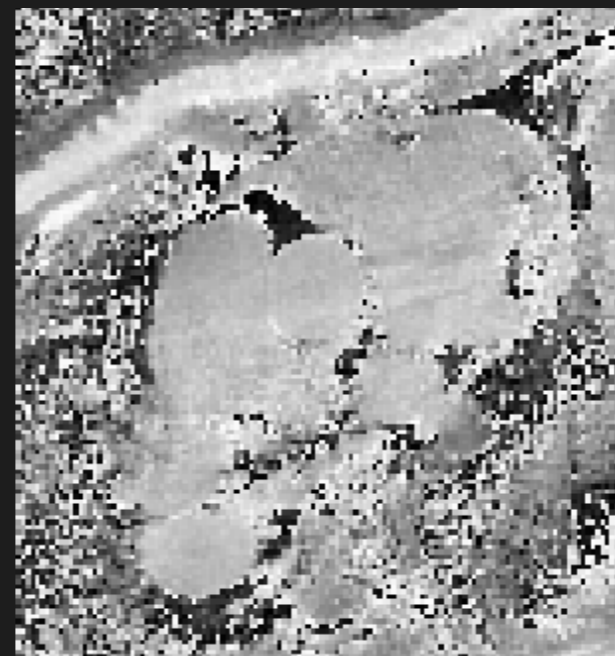

## Minus

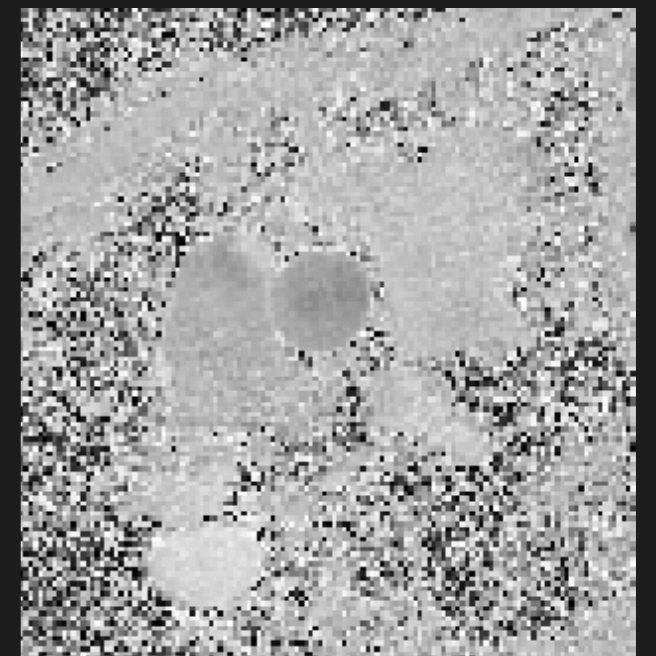

RF

Slice

Phase

Freq

k-space

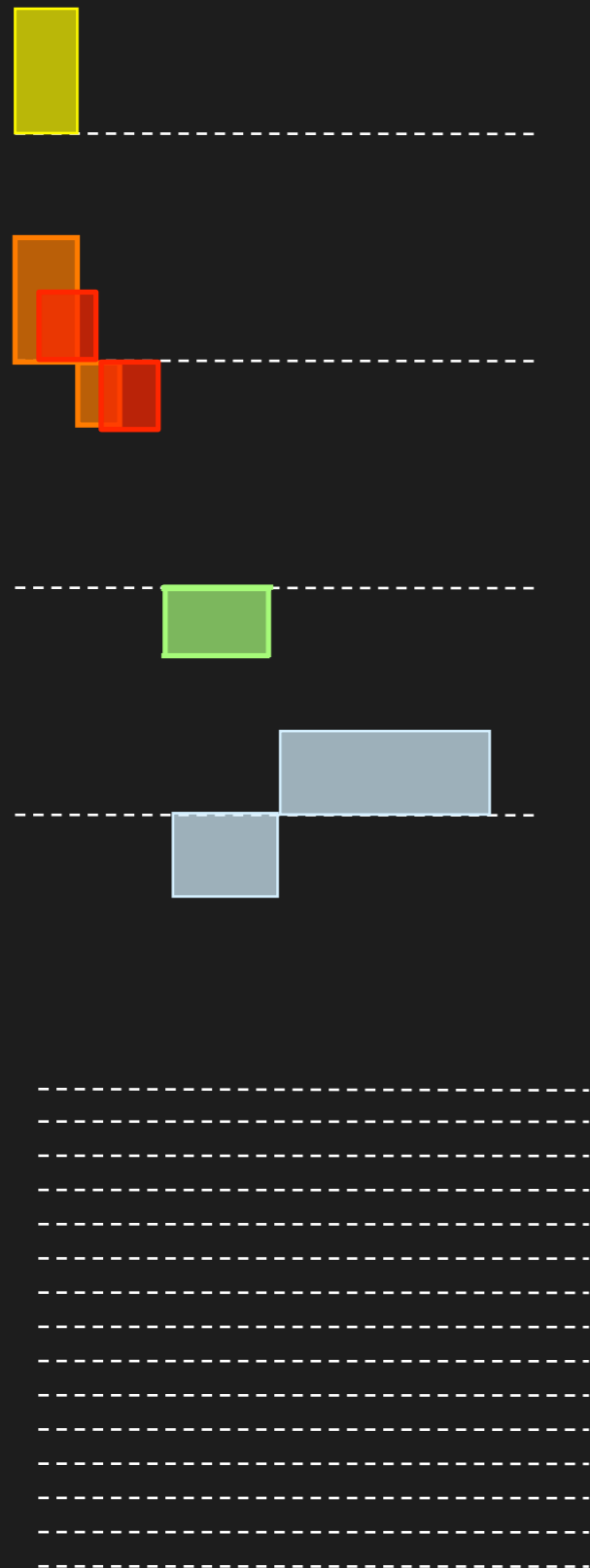

**Phase**

$\propto$

**Velocity (v)**

**Phase**

$\propto$

**Velocity (v)**

**Gradient  
strength**

**Phase**

$\propto$

**Velocity (v)**

**Gradient  
strength**

**Gradient  
time**

**Phase**

$\propto$

**Velocity (v)**

$\times$

**Gradient Moment (M1)**



**Phase**

$\propto$

**Velocity (v)**

$\times$

**Gradient Moment (M1)**

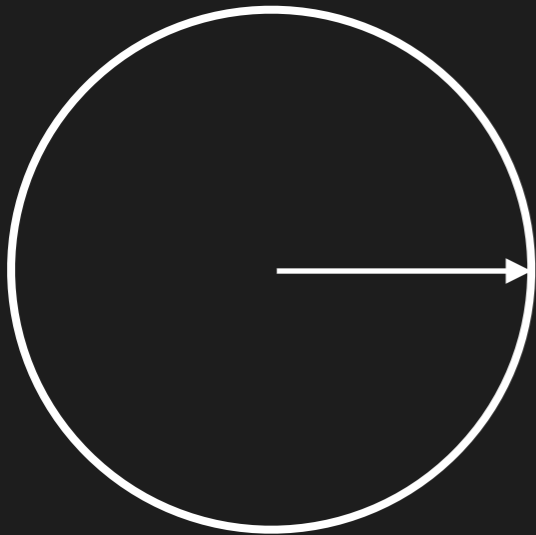

**Phase**

$\propto$

**Velocity (v)**

$\times$

**Gradient Moment (M1)**

**v = 45**

$\times$

**M1 = 2**

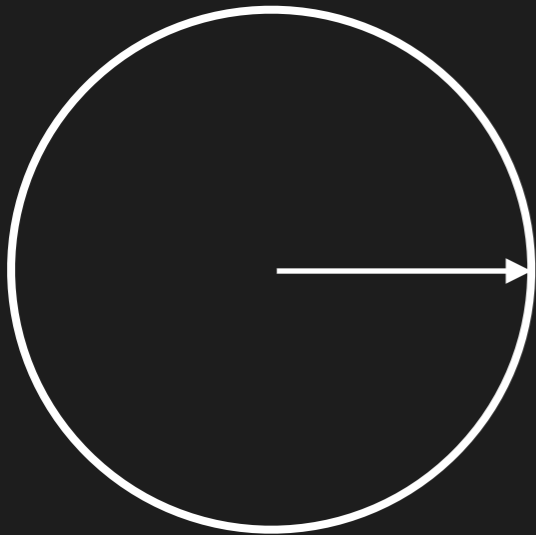

$$\text{Phase} \propto \text{Velocity (v)} \times \text{Gradient Moment (M1)}$$

$$v = 45 \times M1 = 2 = 90$$

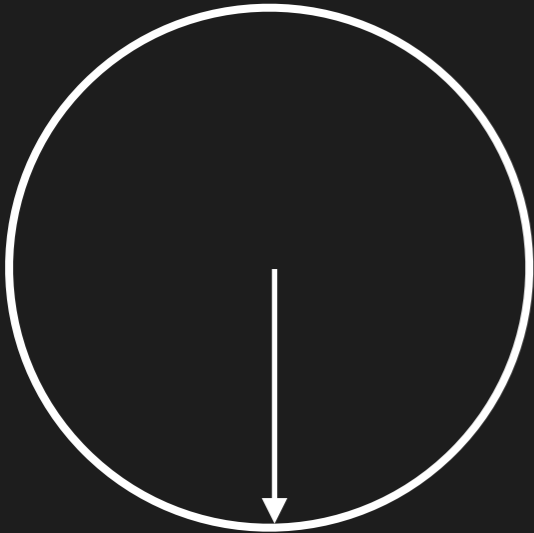

**Phase**

$\propto$

**Velocity (v)**

$\times$

**Gradient Moment (M1)**

**v = 45**

$\times$

**M1 = 2**

$=$

**90**

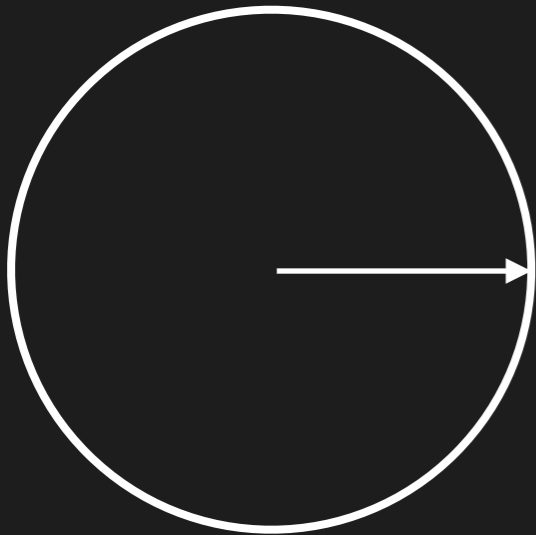

**Phase**

$\propto$

**Velocity (v)**

$\times$

**Gradient Moment (M1)**

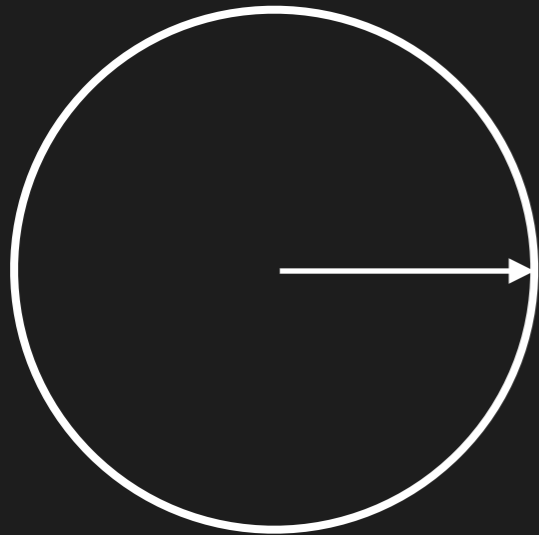

**v = 45**

$\times$

**M1 = 2**

=

**90**

**v = -60**

$\times$

**M1 = 2**

**Phase**

$\propto$

**Velocity (v)**

$\times$

**Gradient Moment (M1)**



**v = 45**

$\times$

**M1 = 2**

**=**

**90**

**v = -60**

$\times$

**M1 = 2**

**=**

**-120**

**Phase**

$\propto$

**Velocity (v)**

$\times$

**Gradient Moment (M1)**

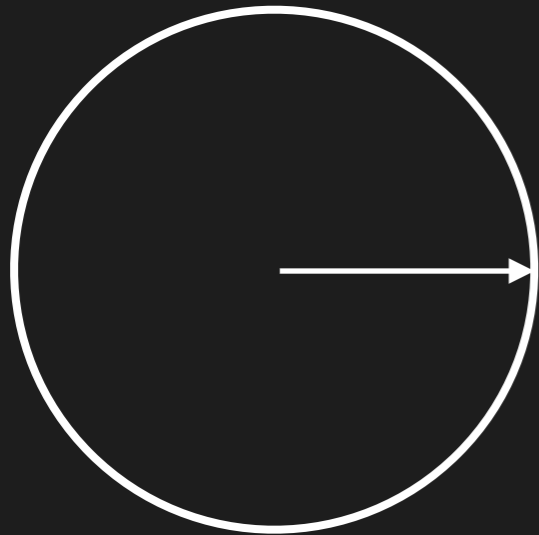

**v = 45**

$\times$

**M1 = 2**

**=**

**90**

**v = -60**

$\times$

**M1 = 2**

**=**

**-120**

**Phase**

$\propto$

**Velocity (v)**

$\times$

**Gradient Moment (M1)**

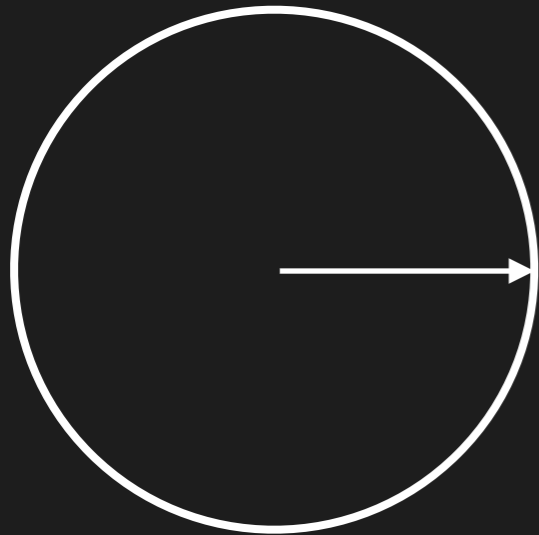

**v = 45**

$\times$

**M1 = 2**

**=**

**90**

**v = -60**

$\times$

**M1 = 2**

**=**

**-120**

**v = 100**

$\times$

**M1 = 2**



**Phase**

$\propto$

**Velocity (v)**

$\times$

**Gradient Moment (M1)**

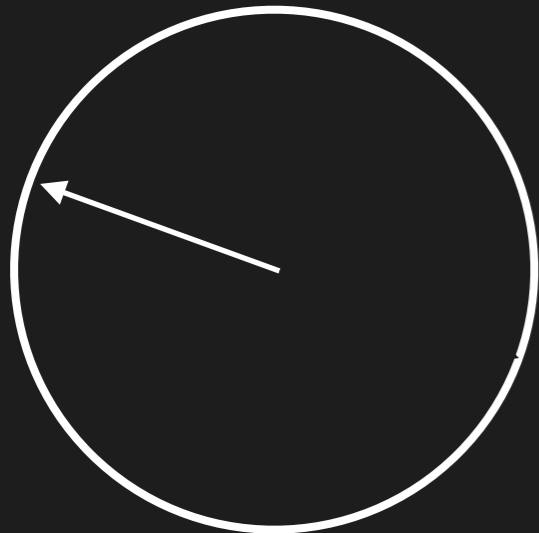

**v = 45**

$\times$

**M1 = 2**

**=**

**90**

**v = -60**

$\times$

**M1 = 2**

**=**

**-120**

**v = 100**

$\times$

**M1 = 2**

**=**

**200 / -160**

**Phase**

$\propto$

**Velocity (v)**

$\times$

**Gradient Moment (M1)**

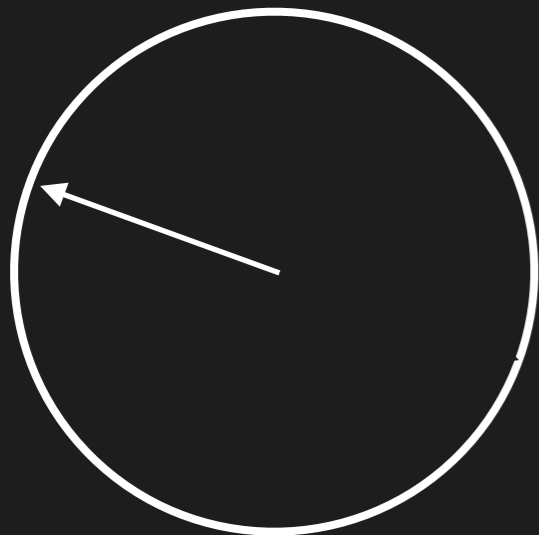

**v = 45**

$\times$

**M1 = 2**

=

**90**

**v = -60**

$\times$

**M1 = 2**

=

**-120**

**v = 100**

$\times$

**M1 = 2**

=

**200 / -160**

**Aliasing**

**Phase**

$\propto$

**Velocity (v)**

$\times$

**Gradient Moment (M1)**

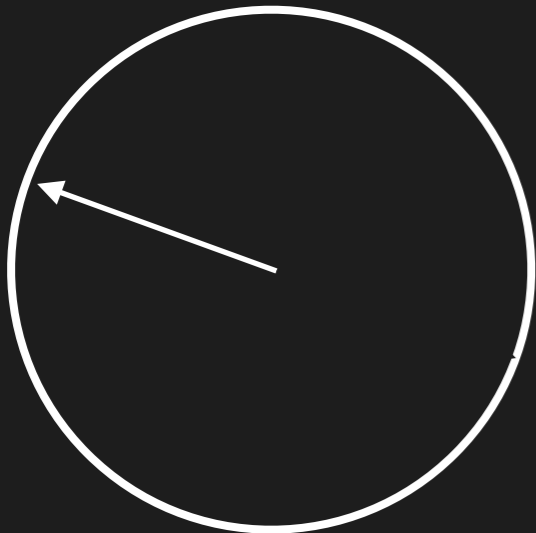

**v = 45**

$\times$

**M1 = 2**

**=**

**90**

**v = -60**

$\times$

**M1 = 2**

**=**

**-120**

**v = 100**

$\times$

**M1 = 2**

**=**

**200 / -160**

**Aliasing**

**Set gradient moment - set VENC**

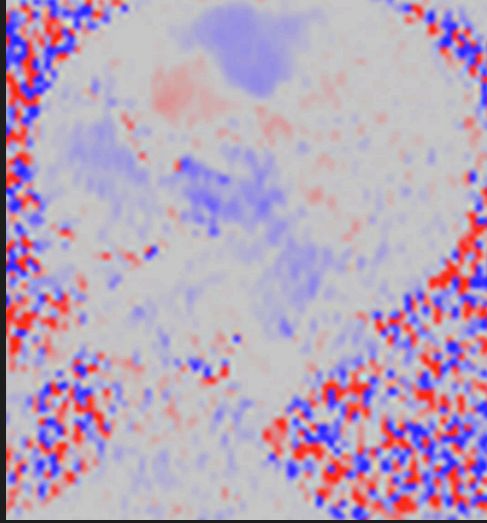

.....

.....

.....

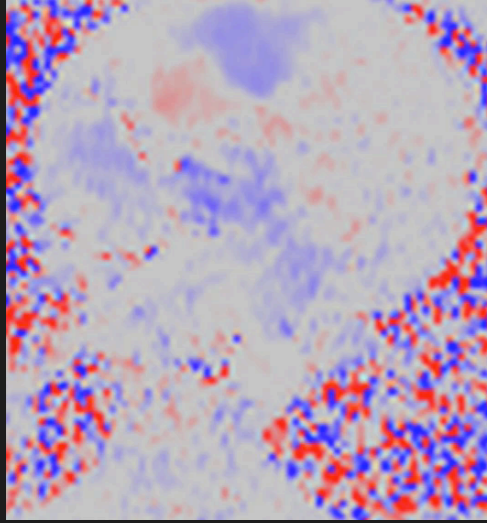

.....

.....

.....

# Setting the VENC part 1

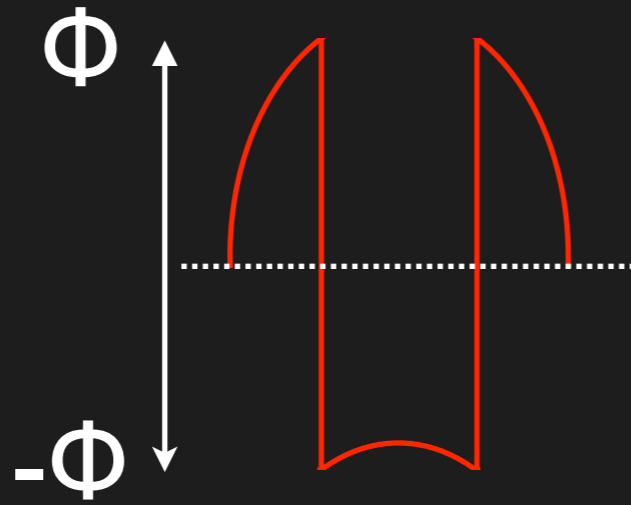
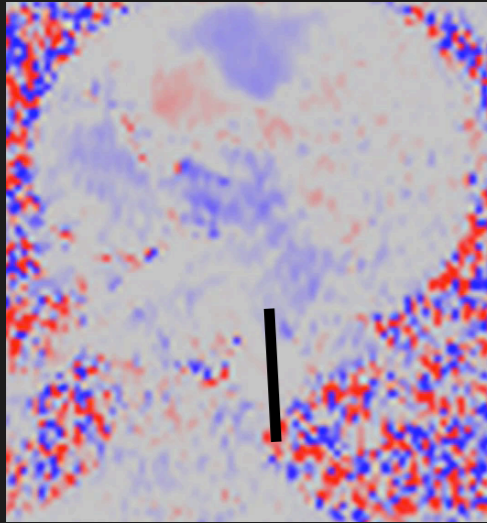

.....

.....

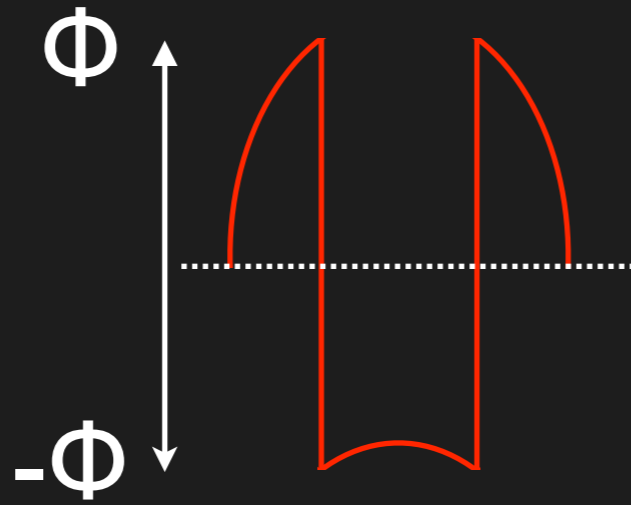
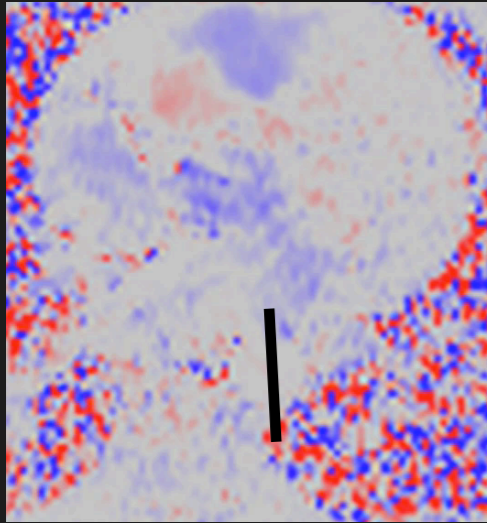

**Aliasing - M1 too large**

.....

.....

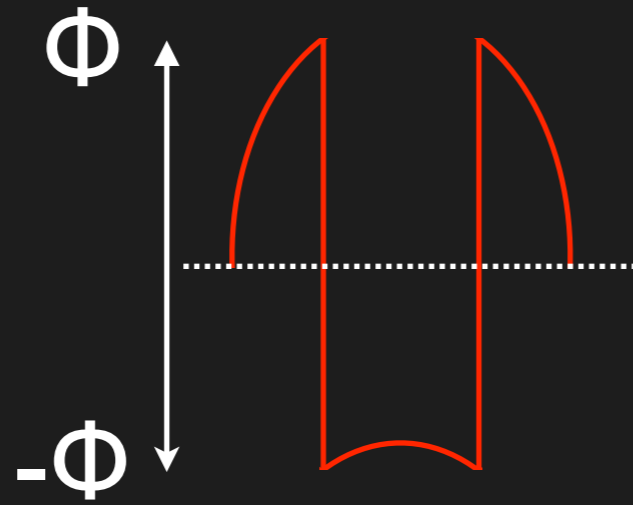
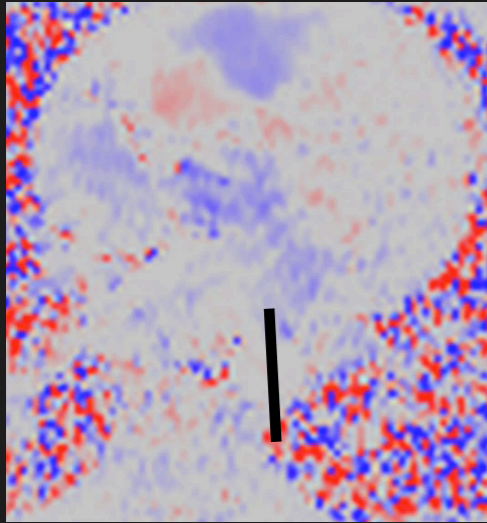

**Aliasing - M1 too large**

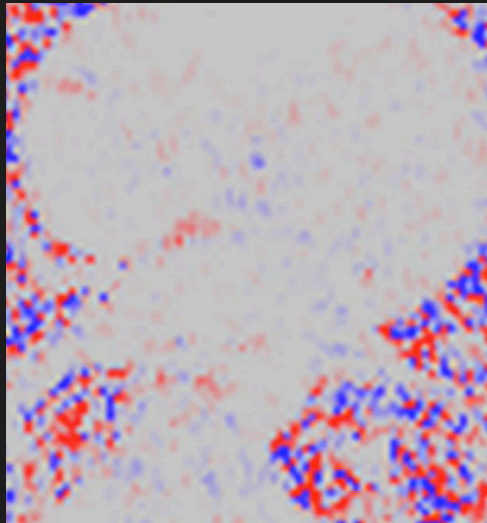



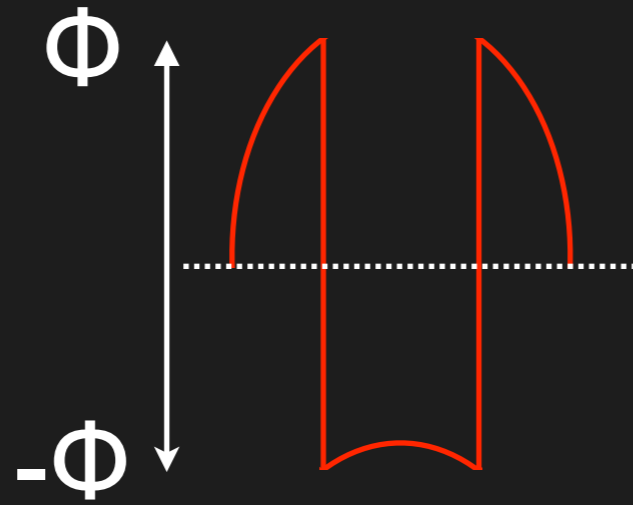
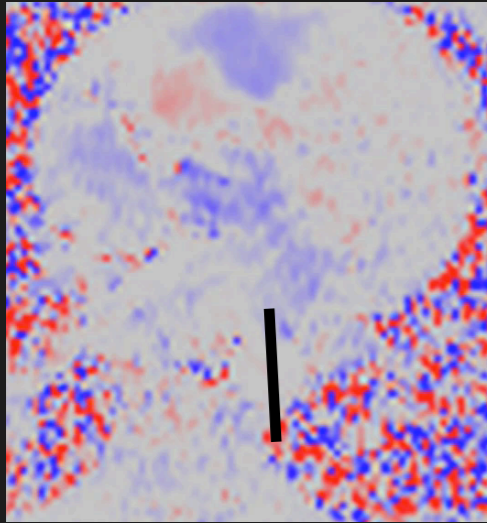

Aliasing - M1 too large

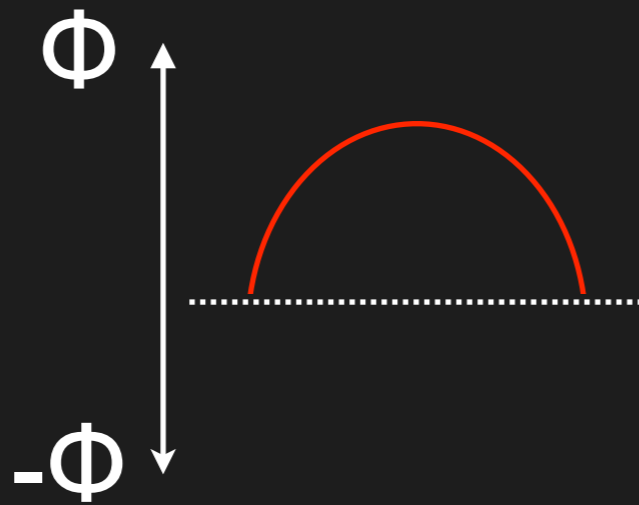
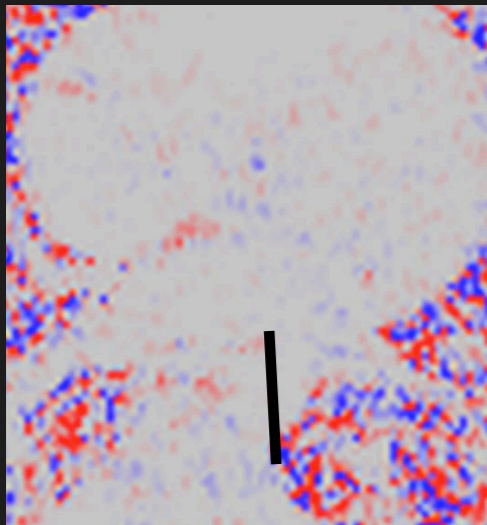

.....

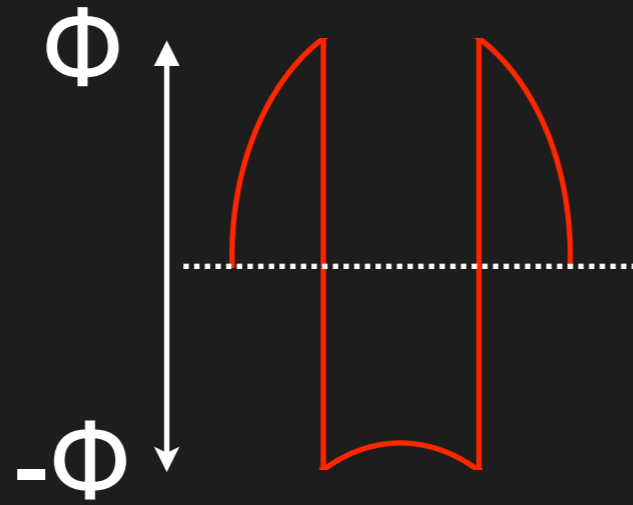
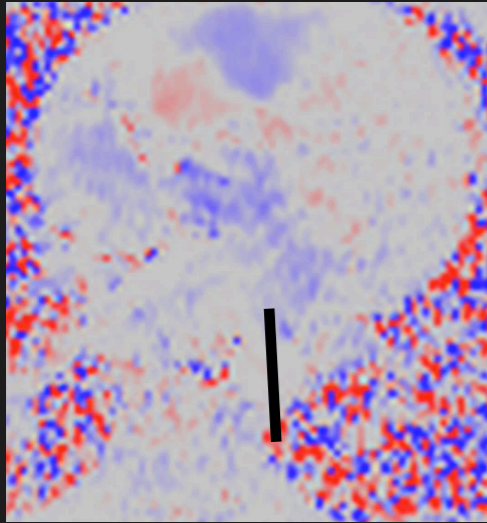

Aliasing - M1 too large

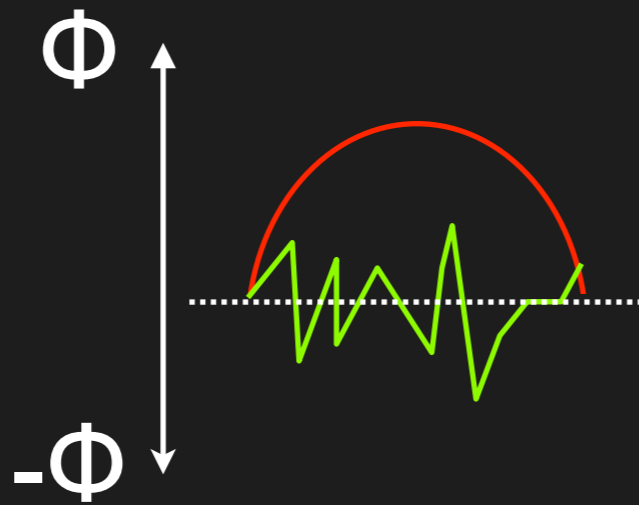
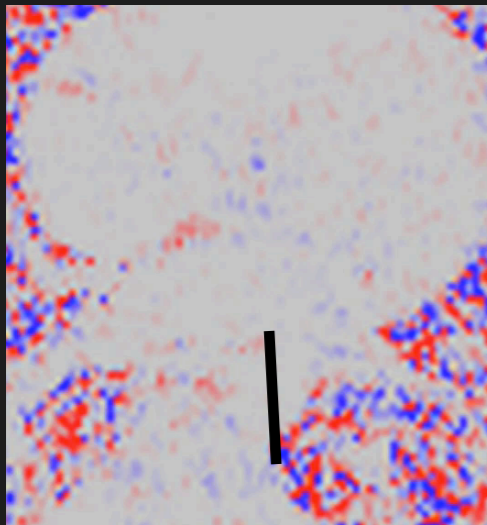

.....

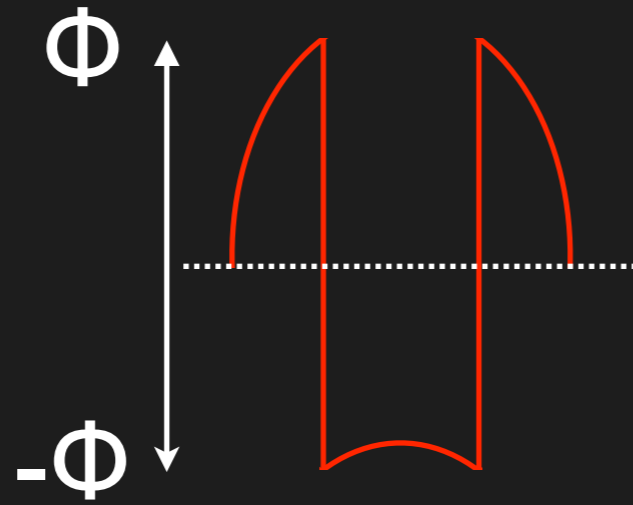
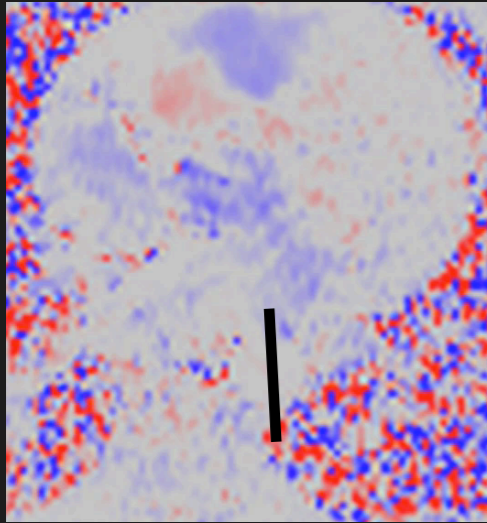

**Aliasing - M1 too large**

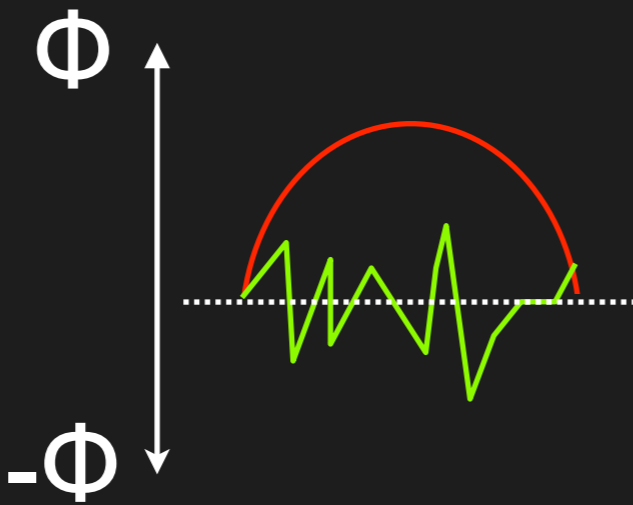
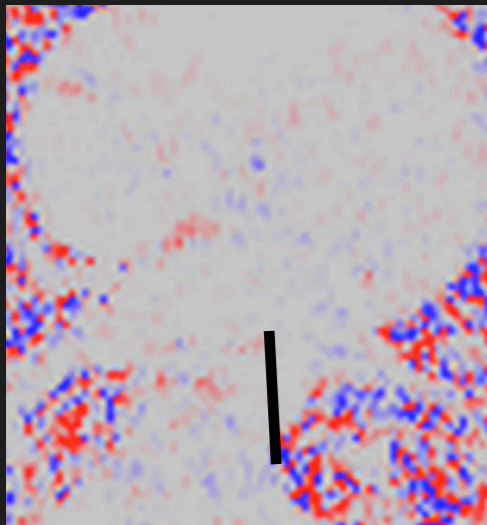

**Low VNR - M1 too small**

.....

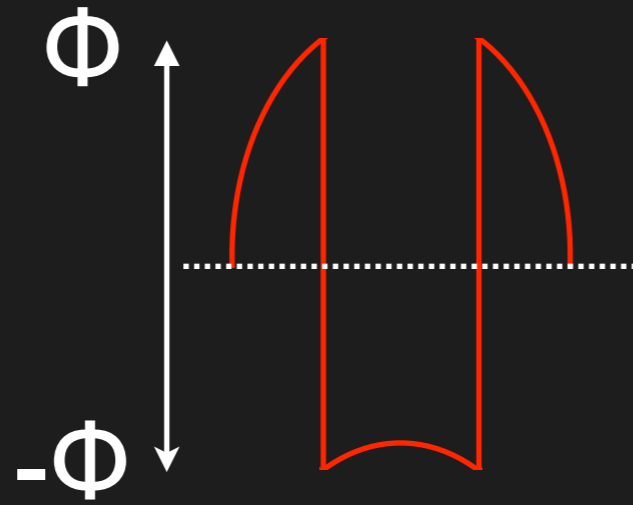
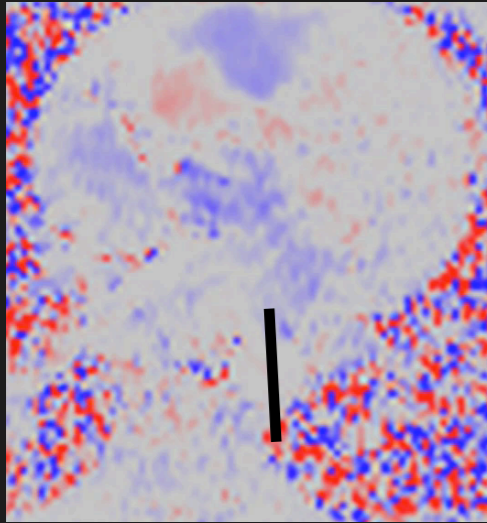

**Aliasing - M1 too large**

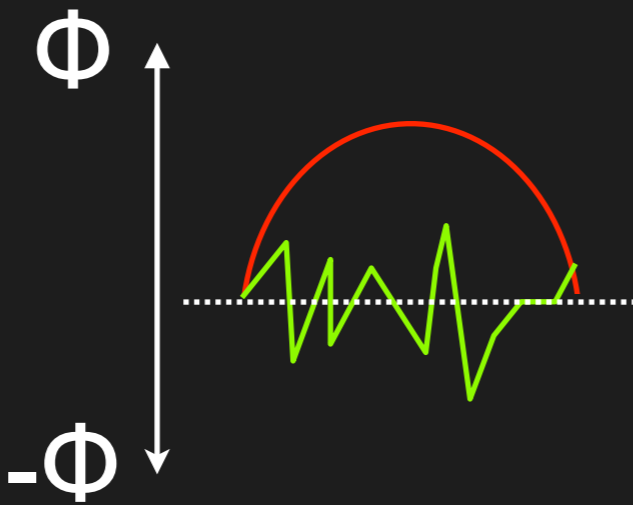
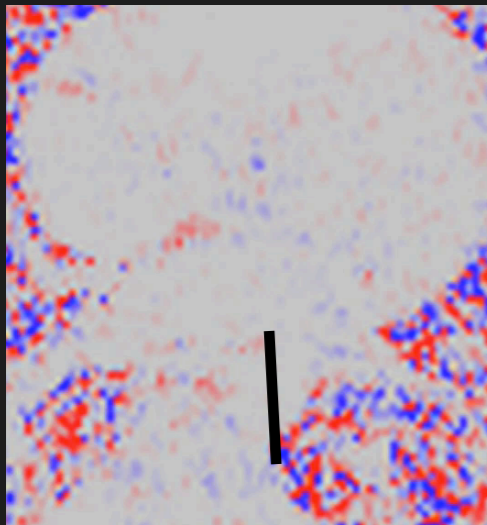

**Low VNR - M1 too small**

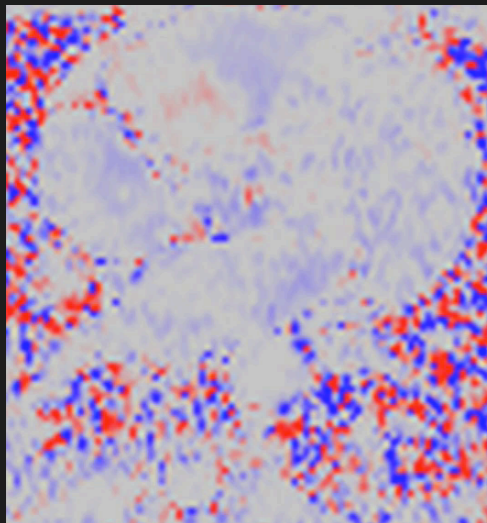

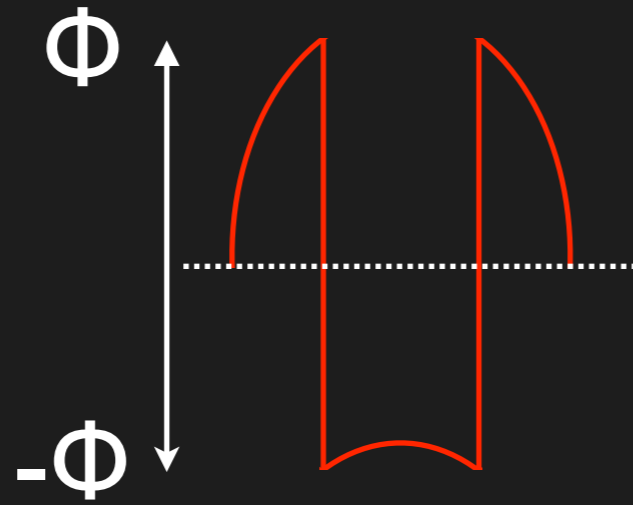
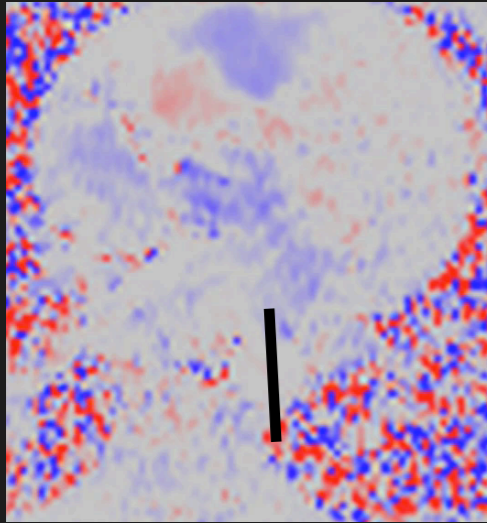

Aliasing - M1 too large

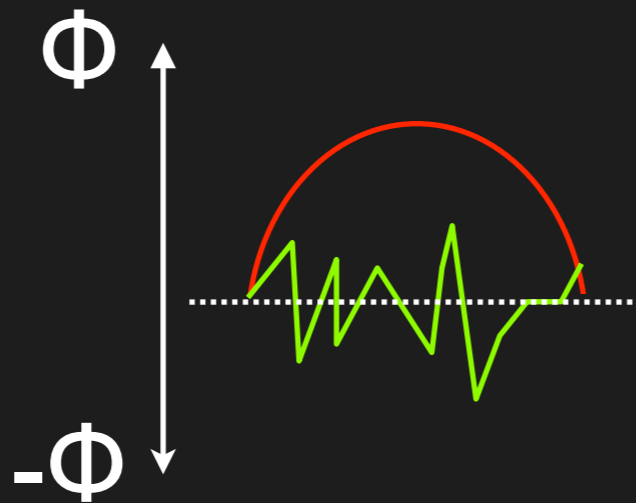
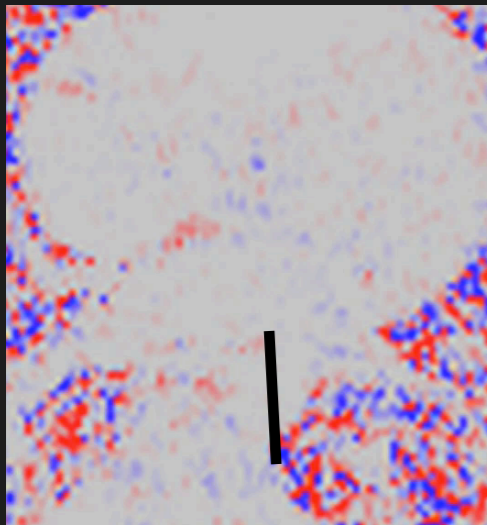

Low VNR - M1 too small

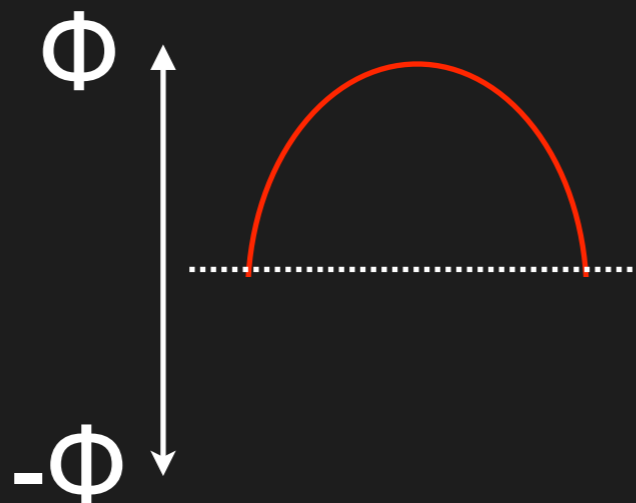
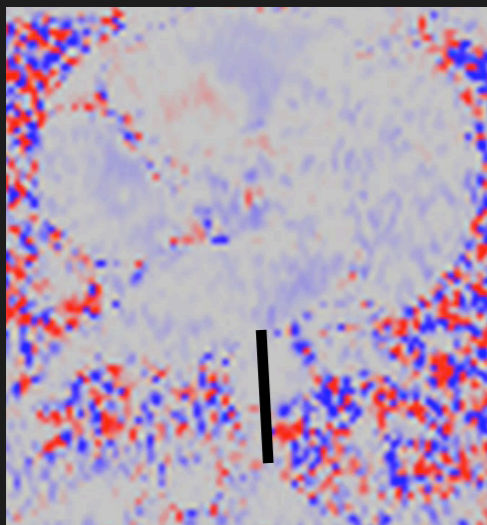

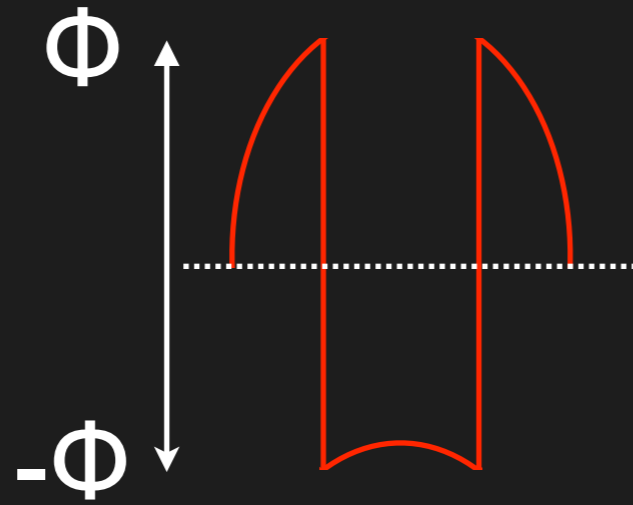
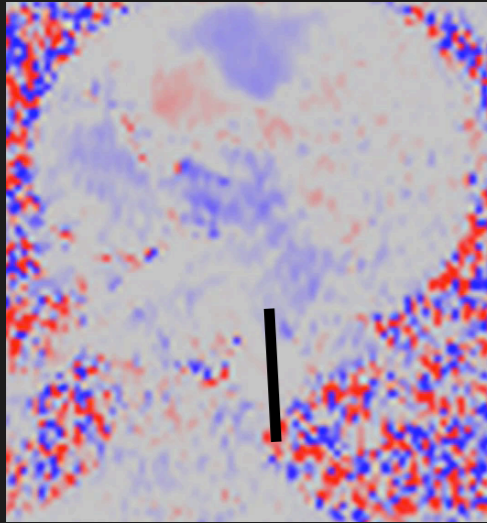

**Aliasing - M1 too large**

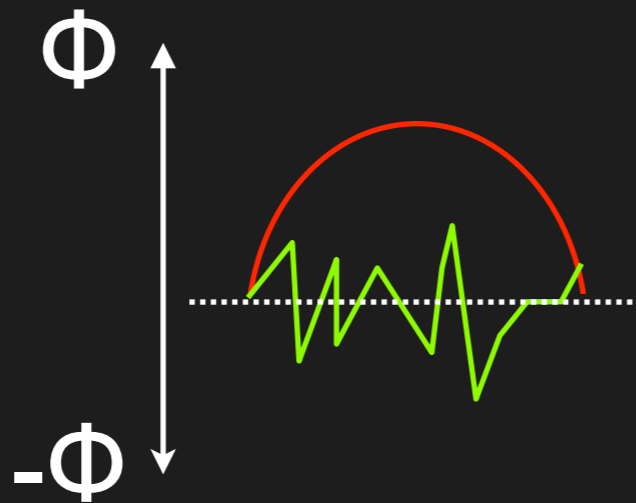
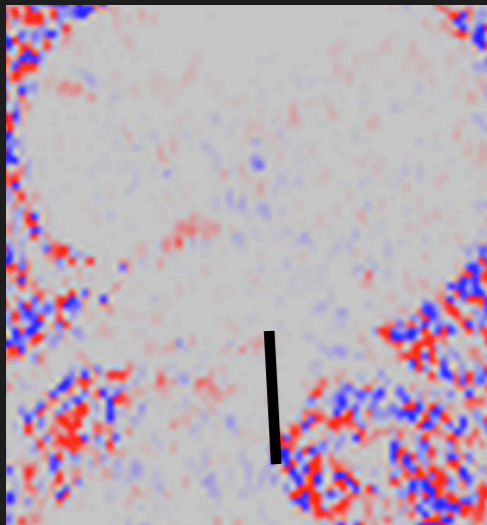

**Low VNR - M1 too small**

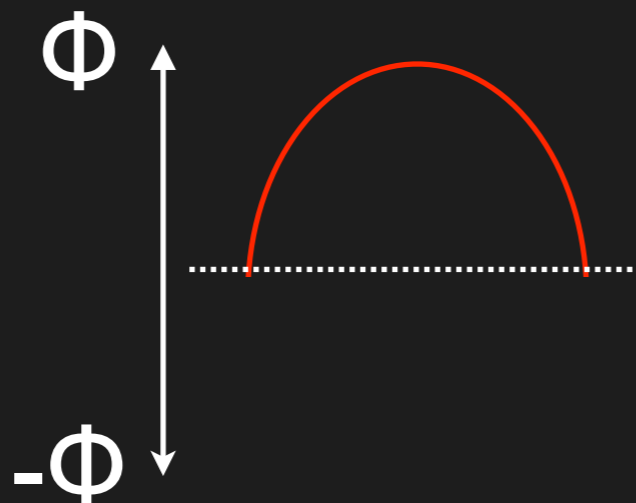
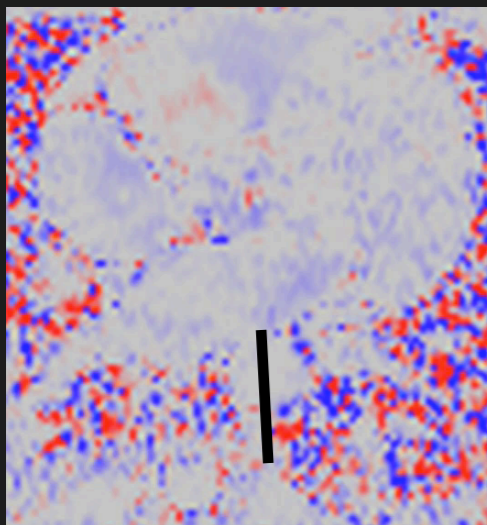

**Set M1 - phase 180°**

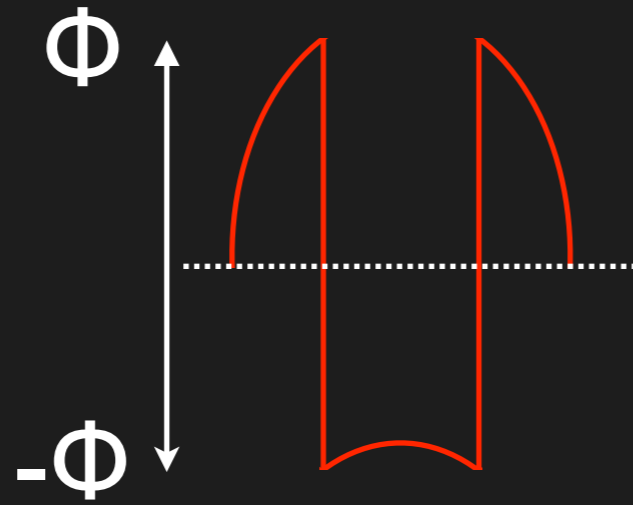
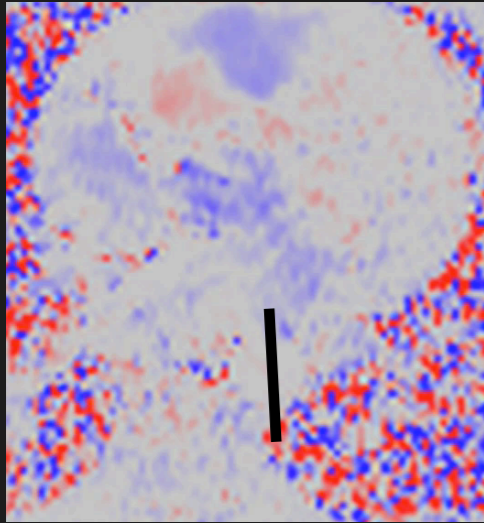

Aliasing - M1 too large

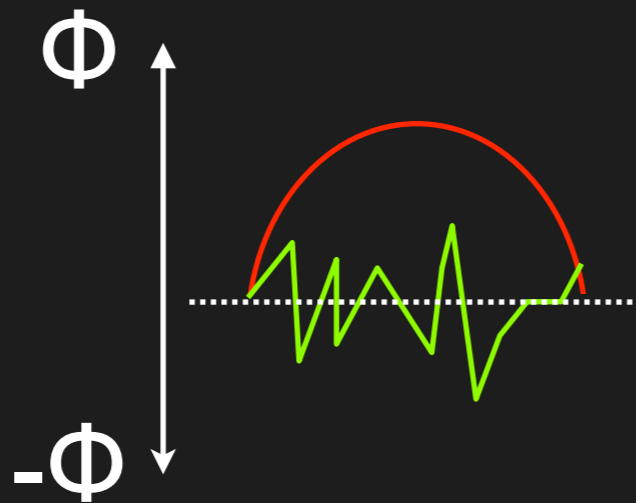
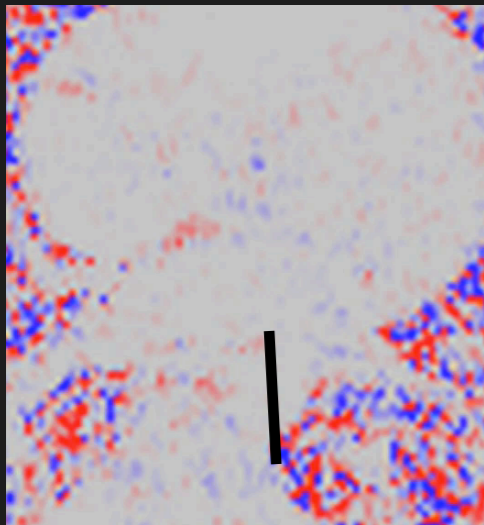

Low VNR - M1 too small

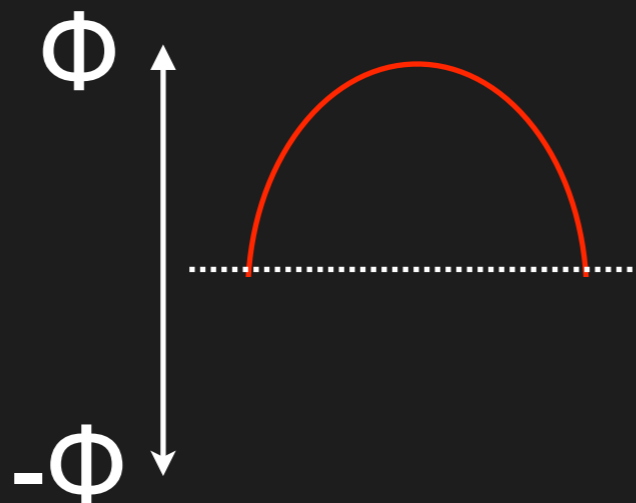
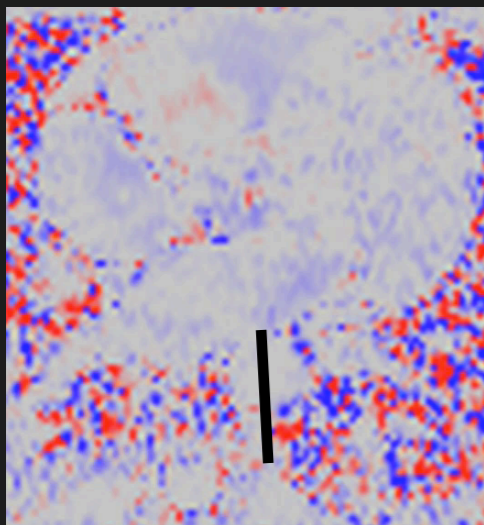

Set M1 - phase 180°

**$M1 = 180^\circ / VENC$**





**Optimisation**

Image planning



Optimisation

**Spatial resolution**

**Image planning**

**Optimisation**

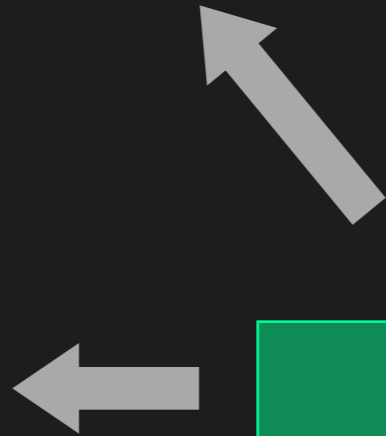

**Spatial resolution**

**Temporal resolution**

**Image planning**

**Optimisation**

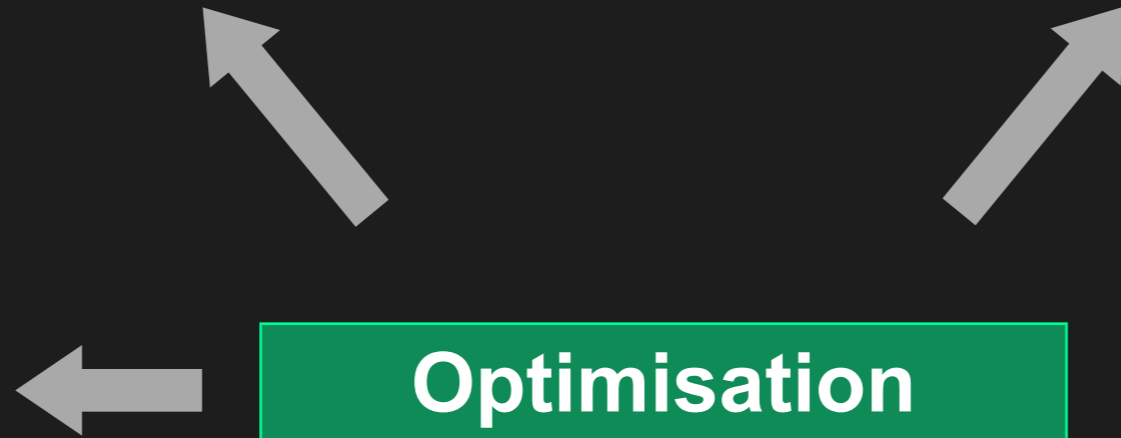

**Spatial resolution**

**Temporal resolution**

**Image planning**

**Optimisation**

**Breathing**

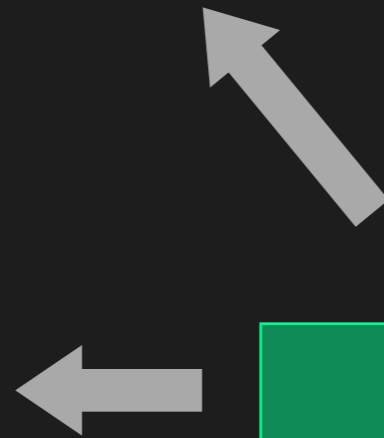

Spatial resolution

Temporal resolution

Image planning

Optimisation

Breathing

Errors

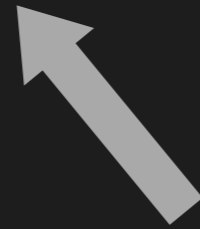

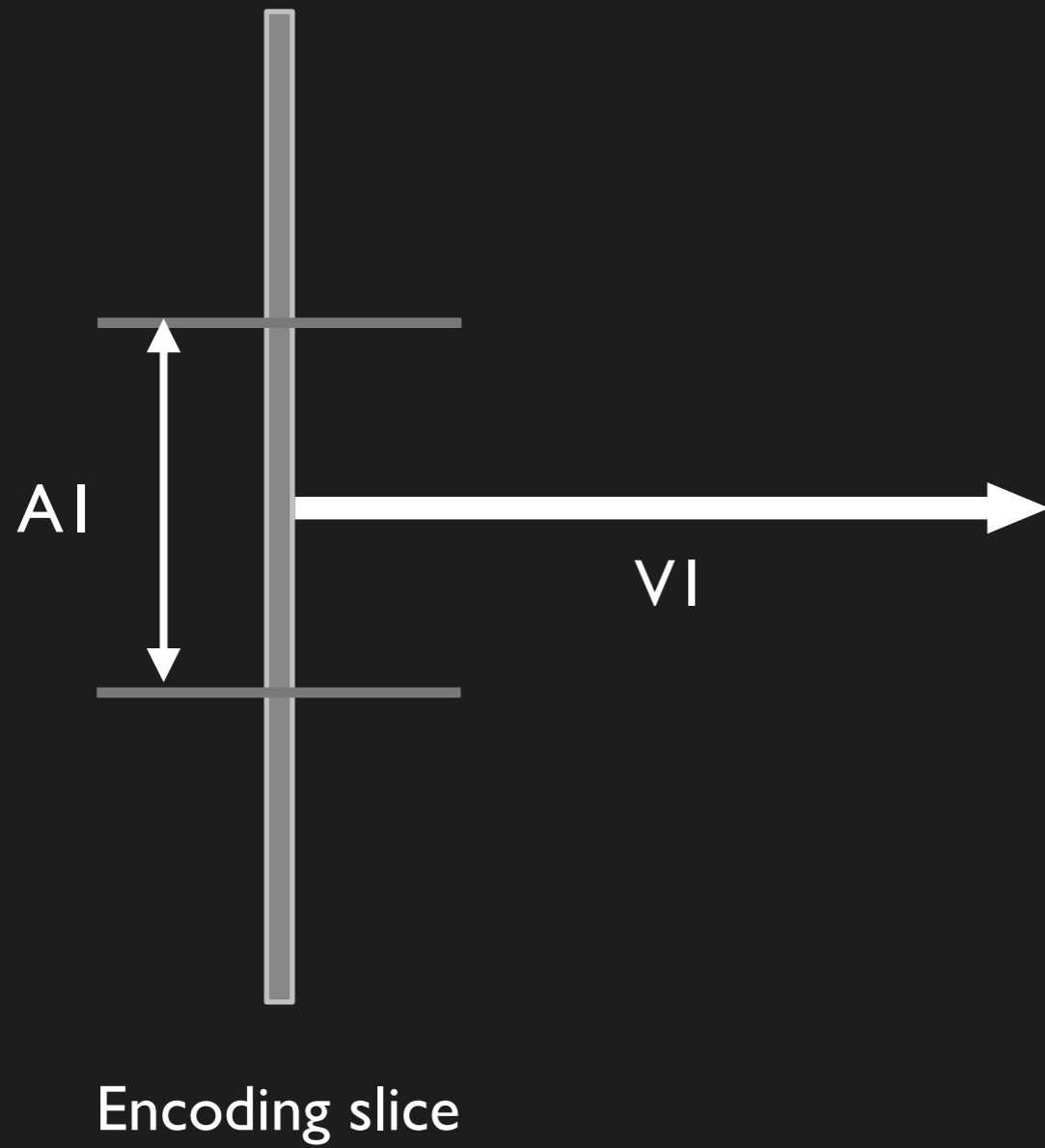

$$Q = V1 \times A1$$

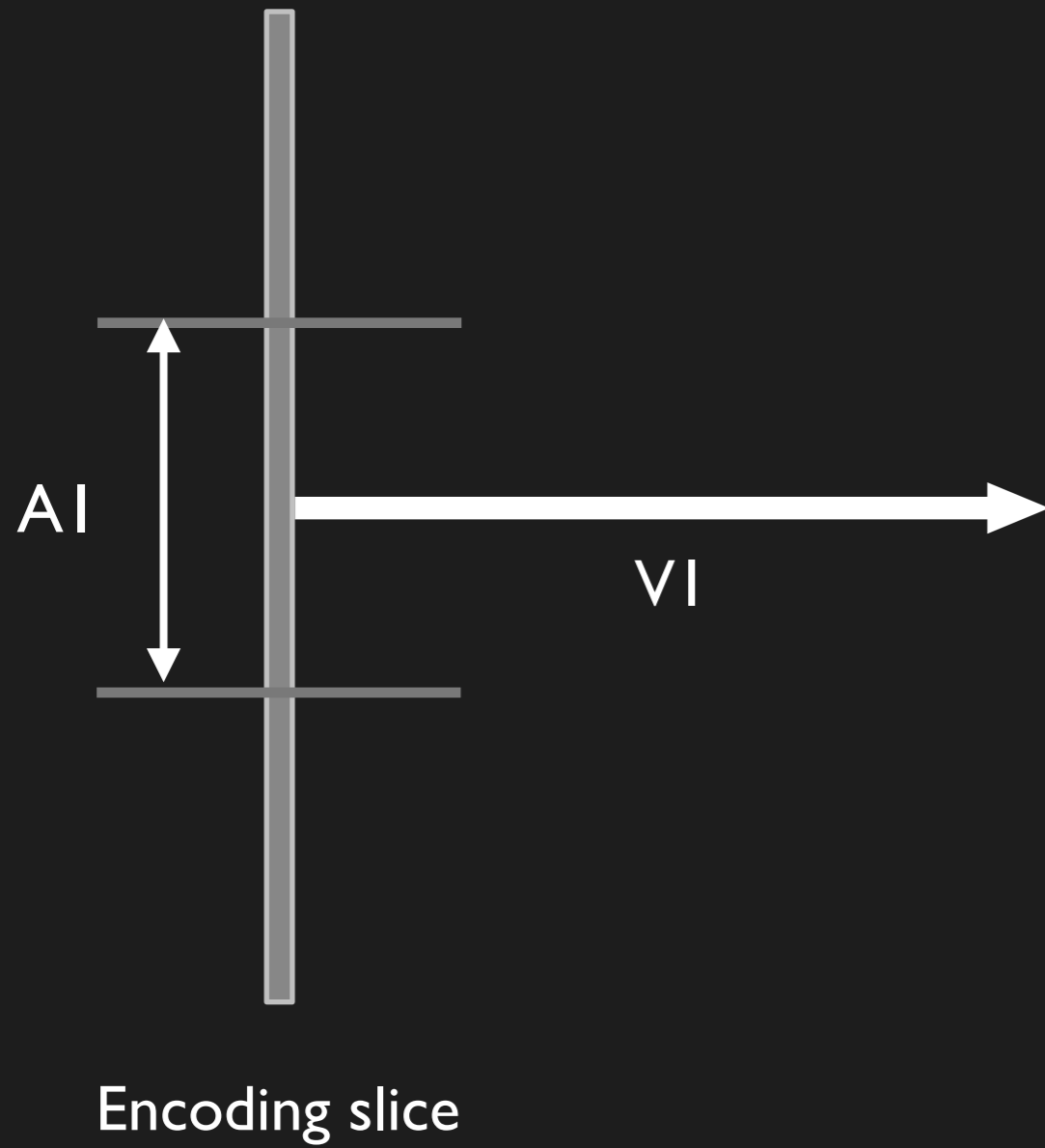



$$Q = V1 \times A1$$

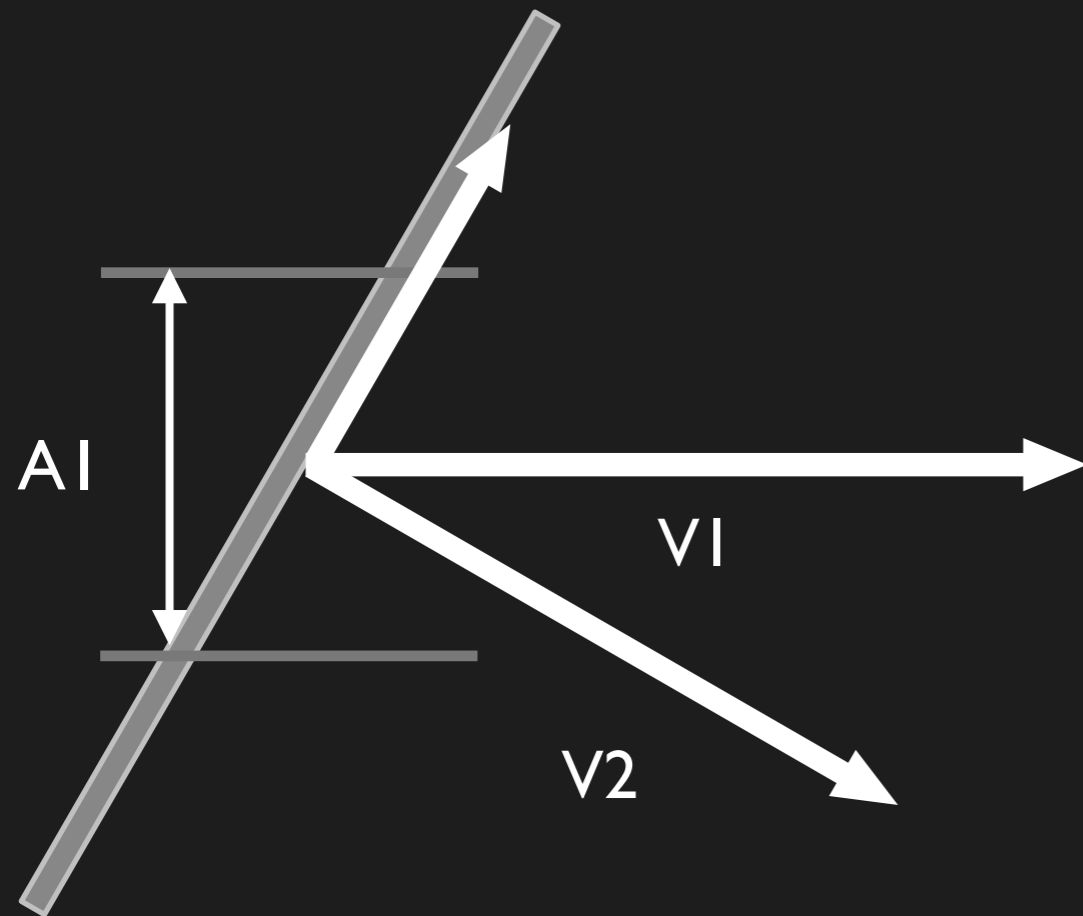

Encoding slice

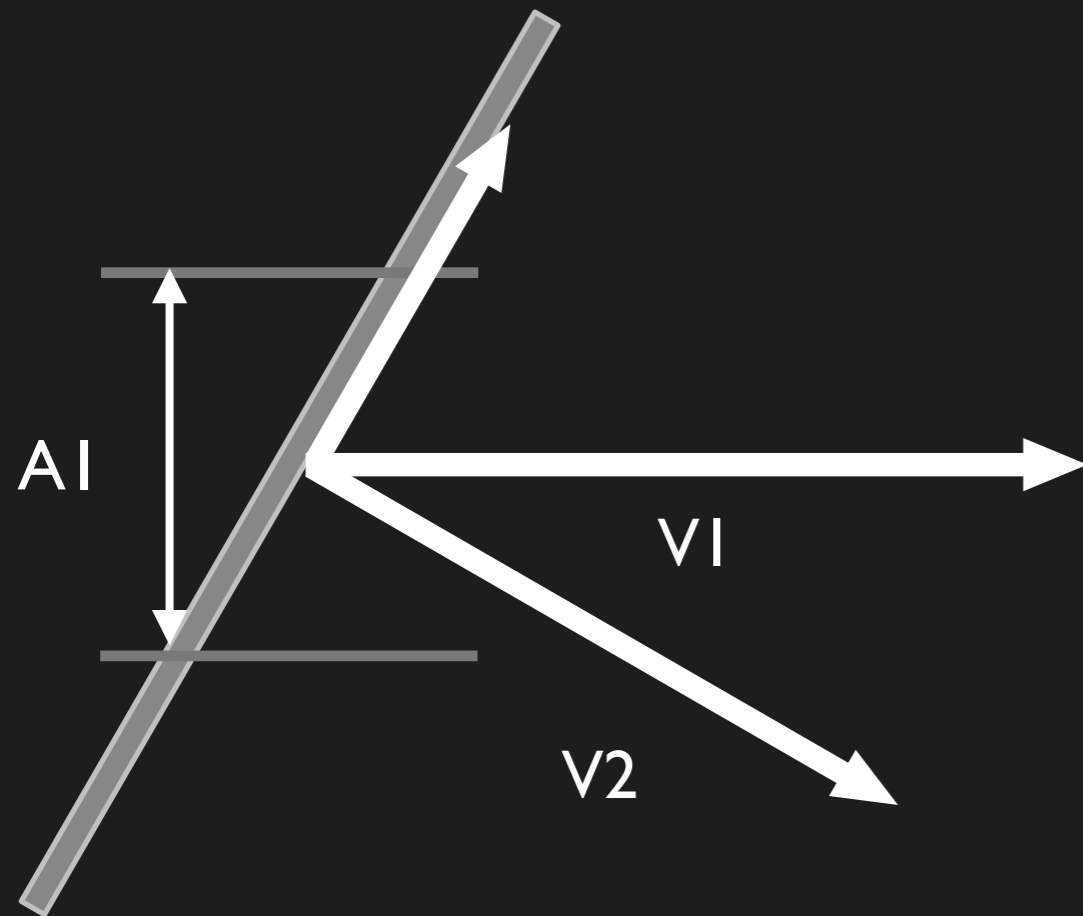

Encoding slice

$$Q = V1 \times A1$$

$$V2 = V1 \times \cos \Phi$$

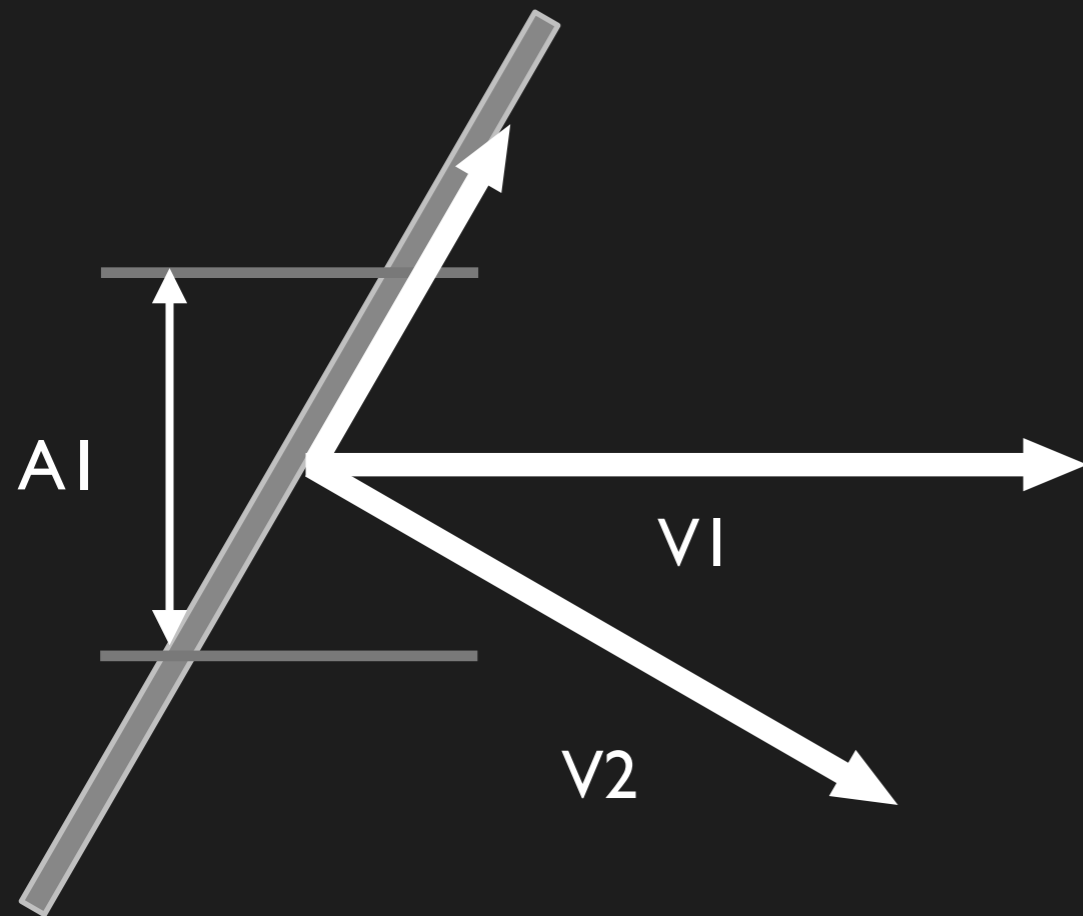

Encoding slice

$$Q = V1 \times A1$$

$$V2 = V1 \times \cos \Phi$$

Does Q go down?

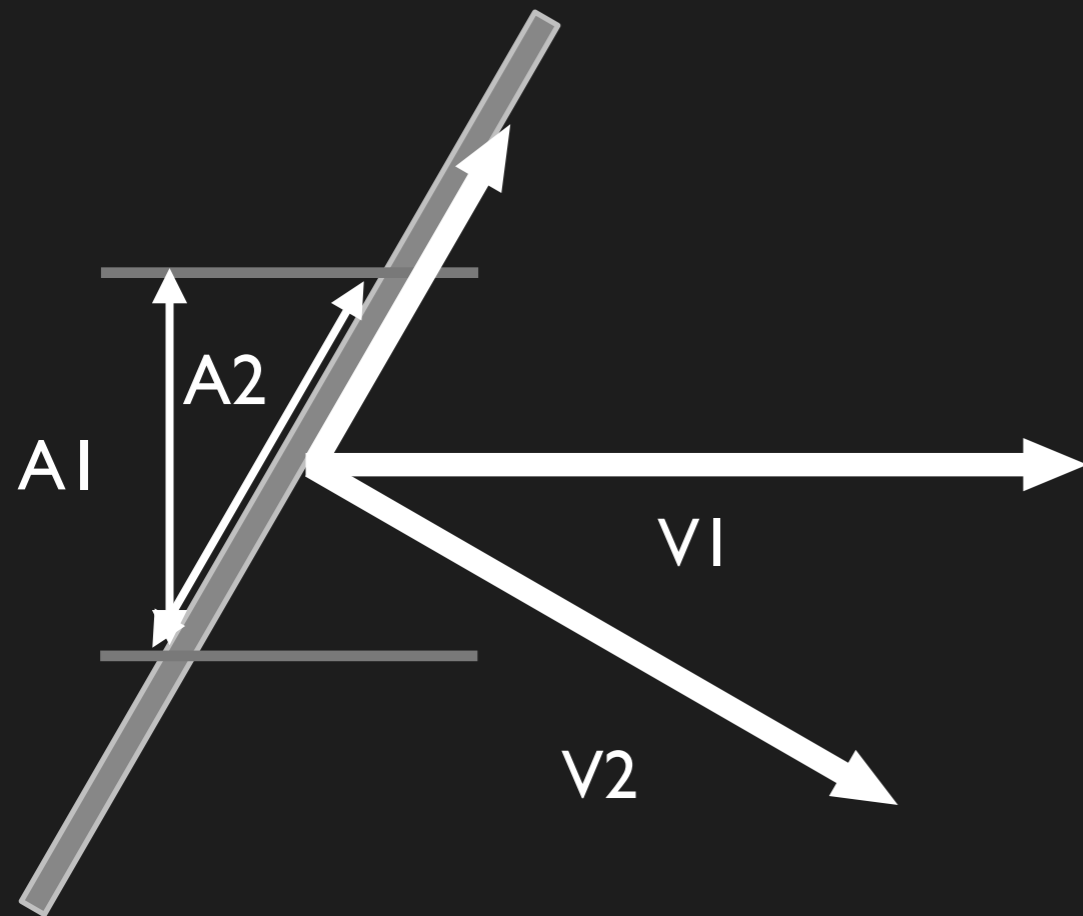

Encoding slice

$$Q = V1 \times A1$$

$$V2 = V1 \times \cos \Phi$$

Does Q go down?

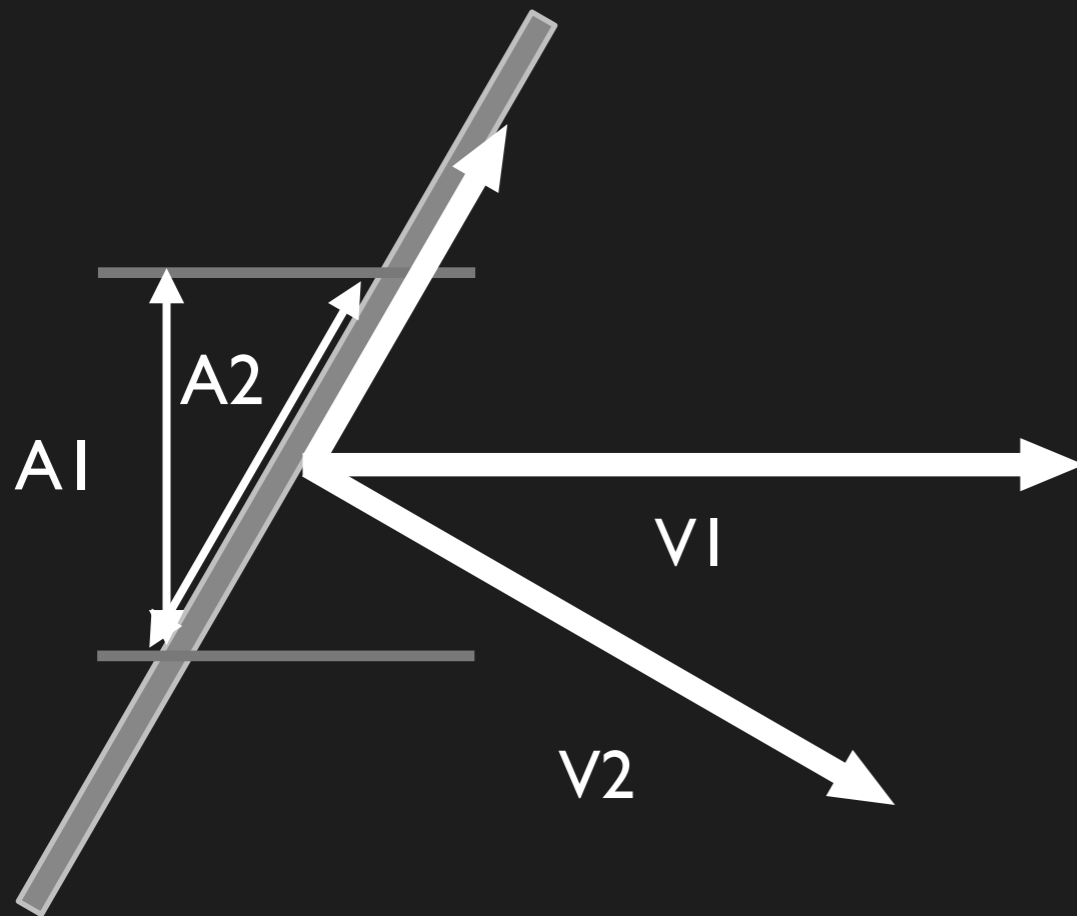

$$Q = V1 \times A1$$

$$V2 = V1 \times \cos \Phi$$

Does Q go down?

$$A2 = A1 / \cos \Phi$$

Angles cancel out

Encoding slice

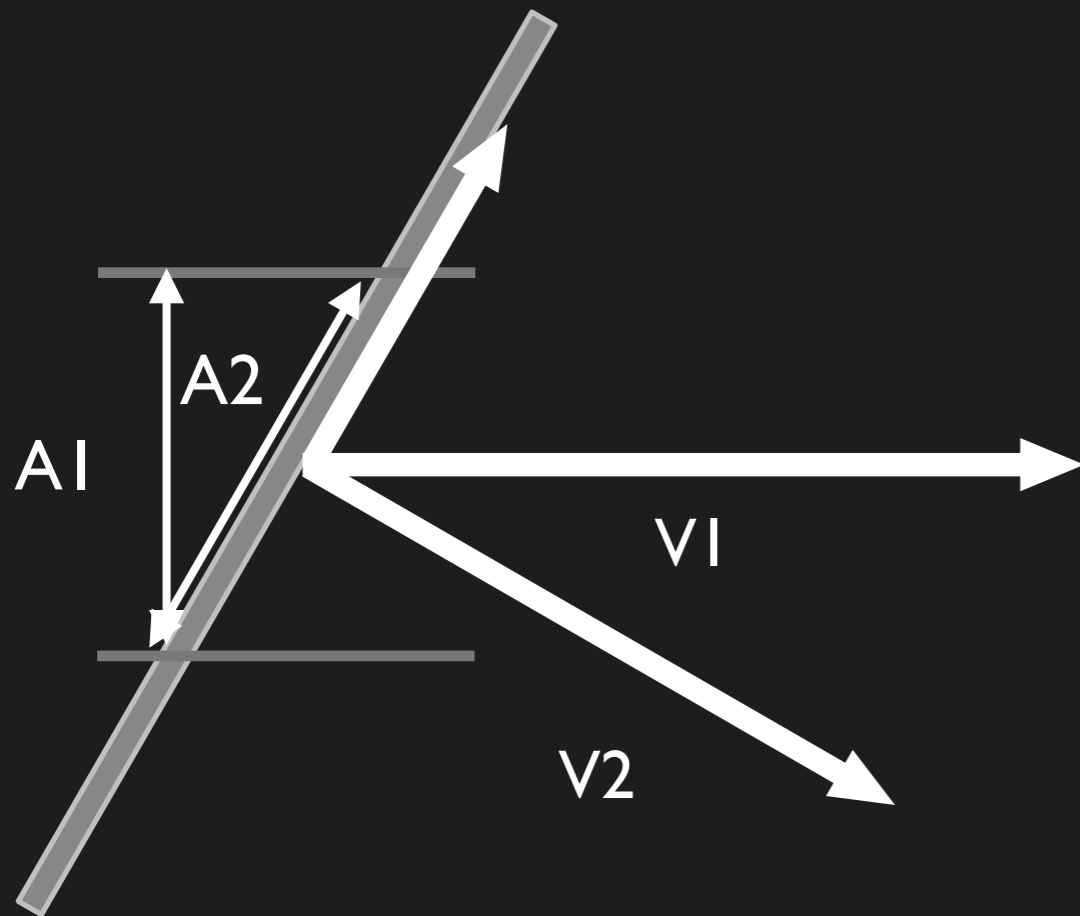

Encoding slice

$$Q = V1 \times A1$$

$$V2 = V1 \times \cos \Phi$$

Does Q go down?

$$A2 = A1 / \cos \Phi$$

Angles cancel out

So does angle matter

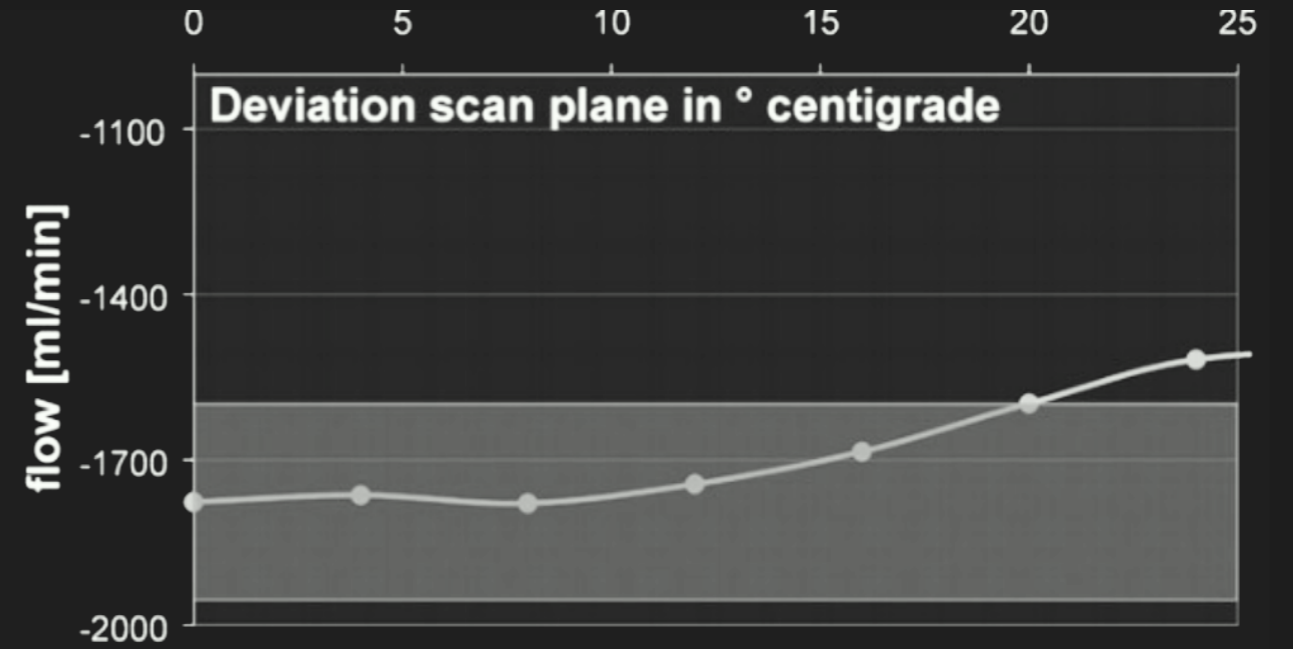
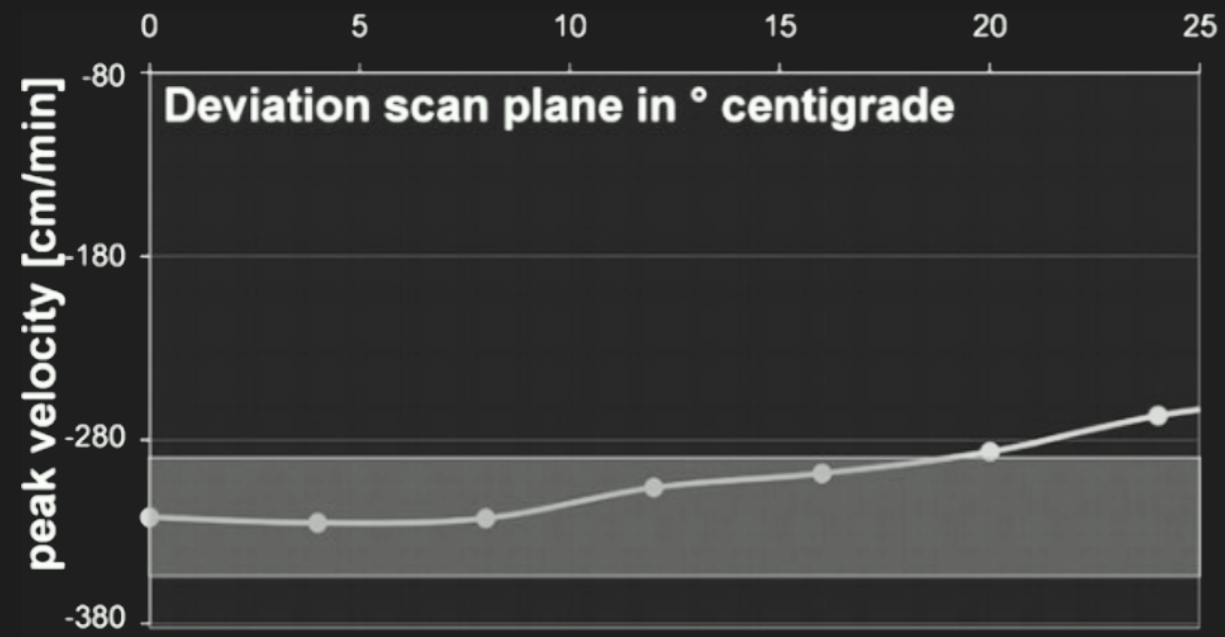

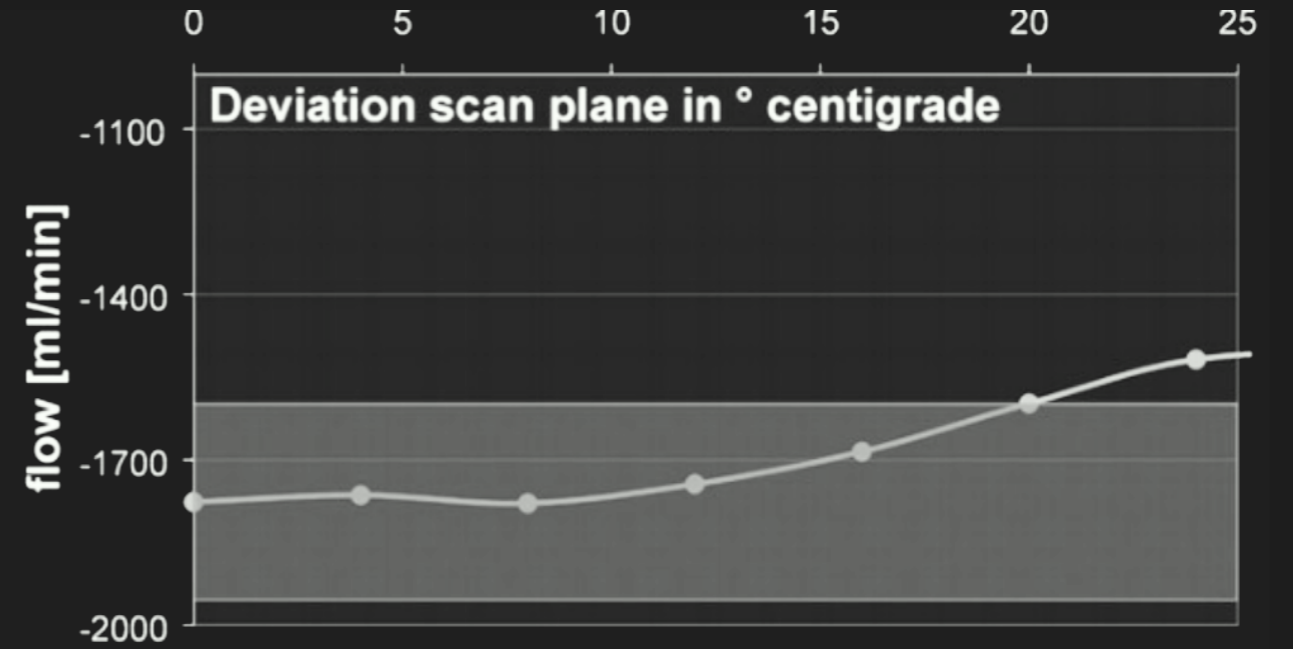
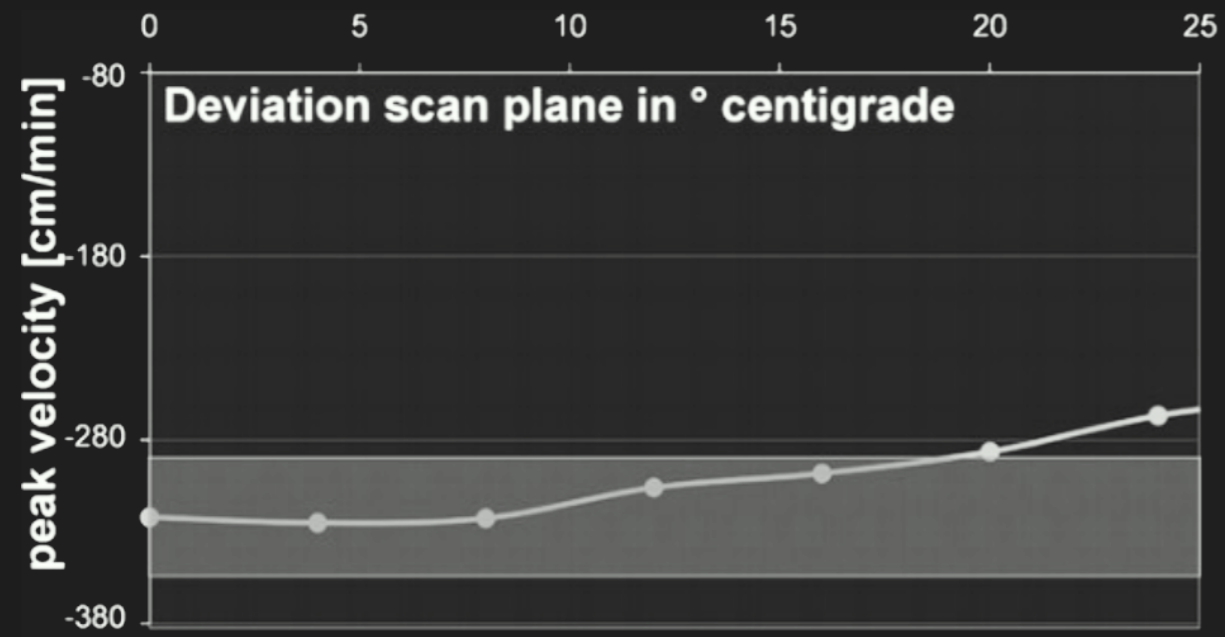



Yes!

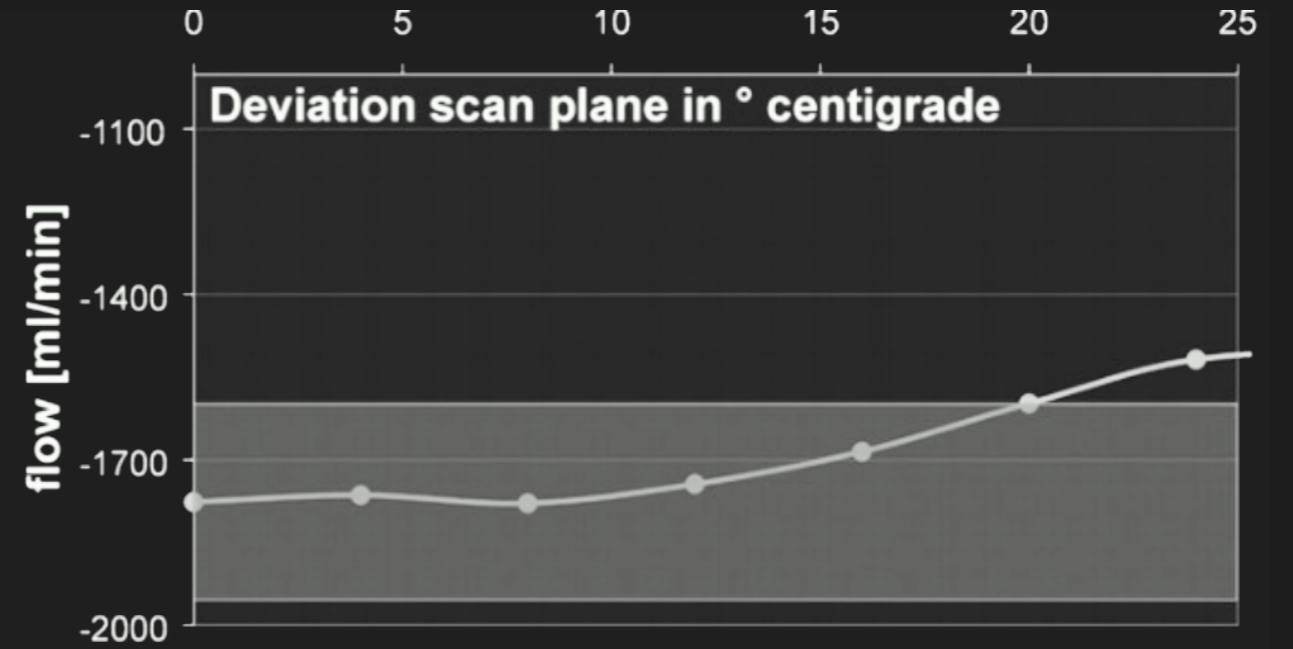
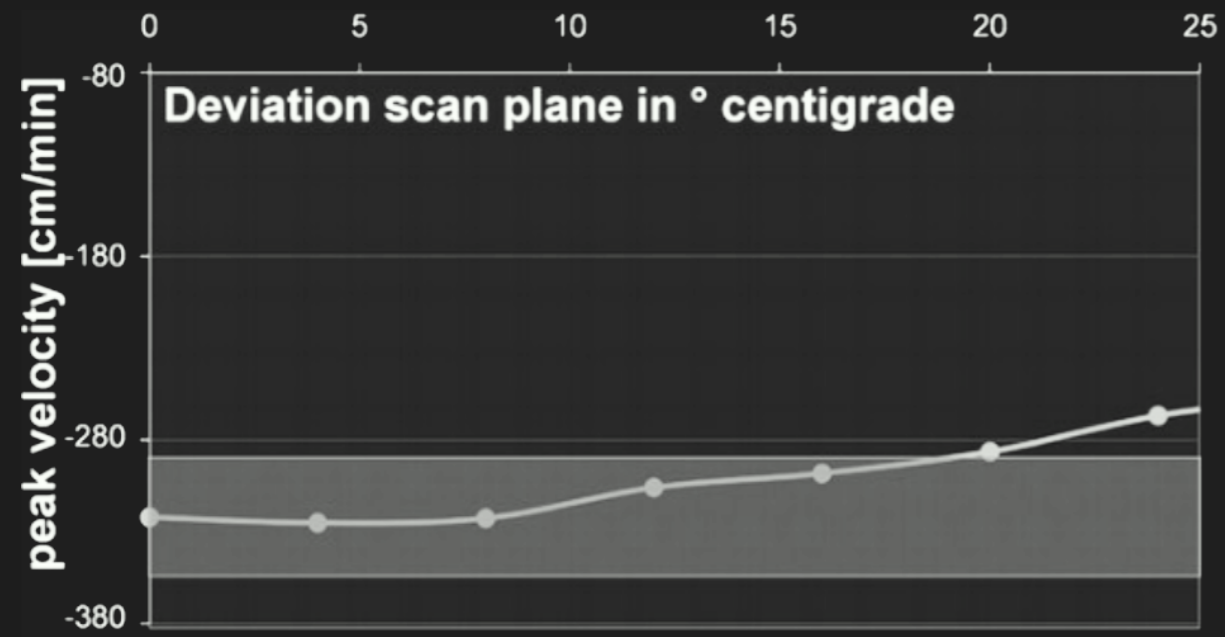

**Yes!**

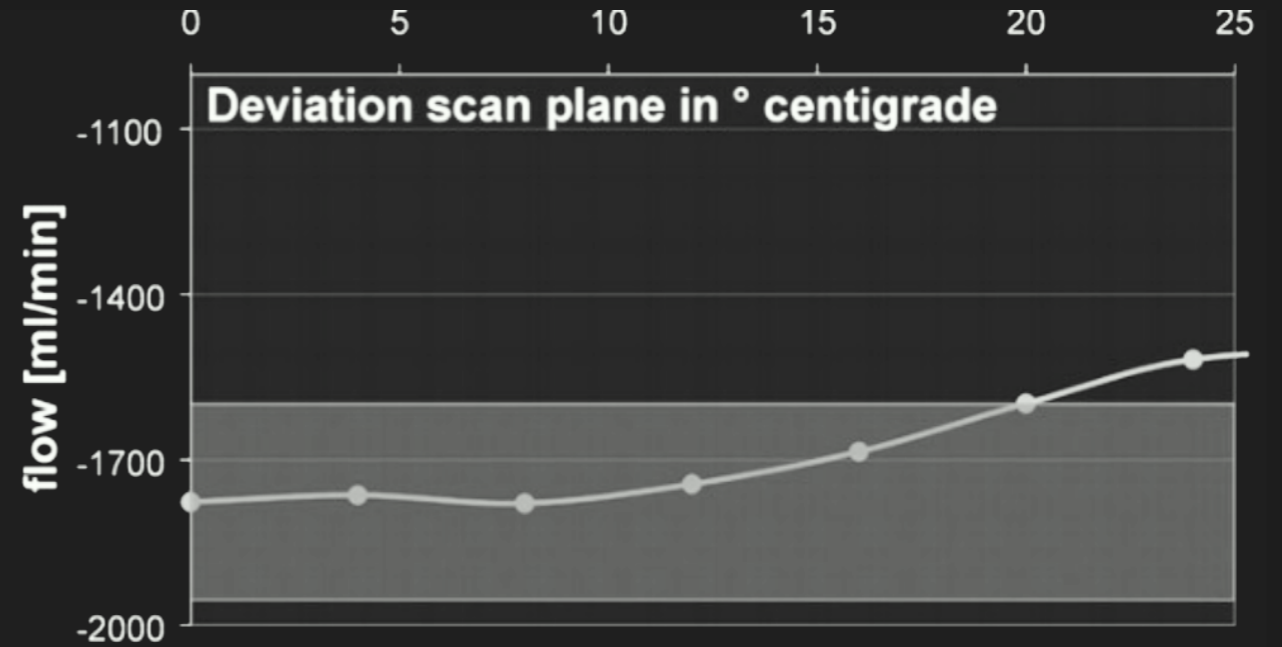
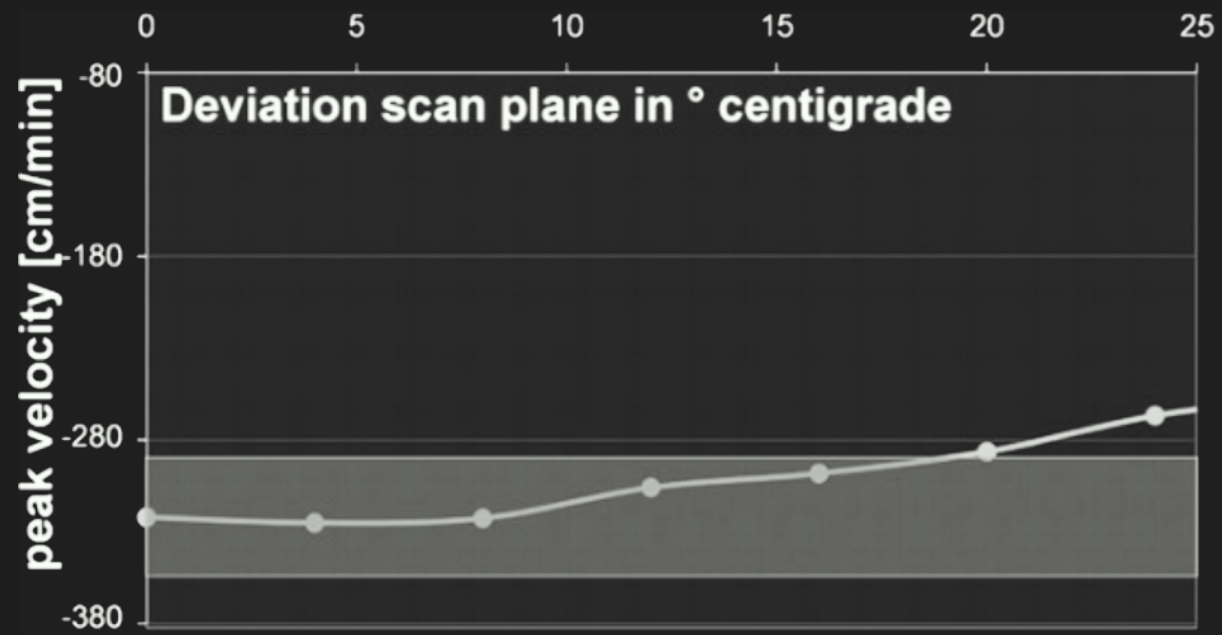

**15 degree rule**

**Yes!**

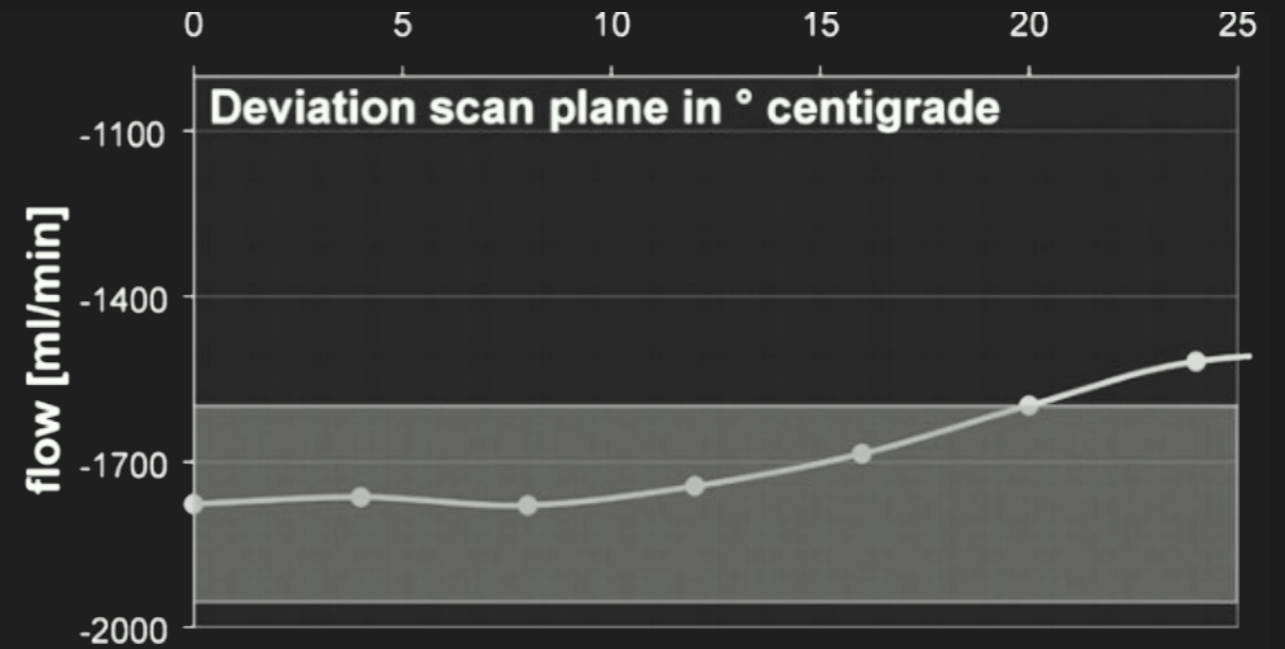
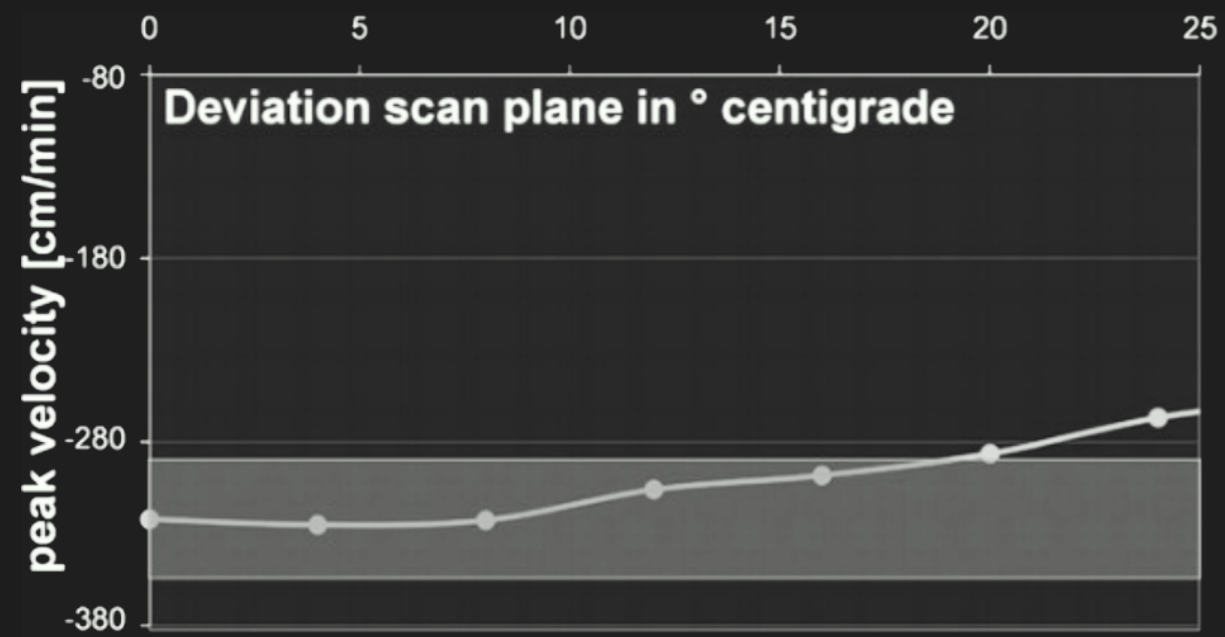

**15 degree rule**

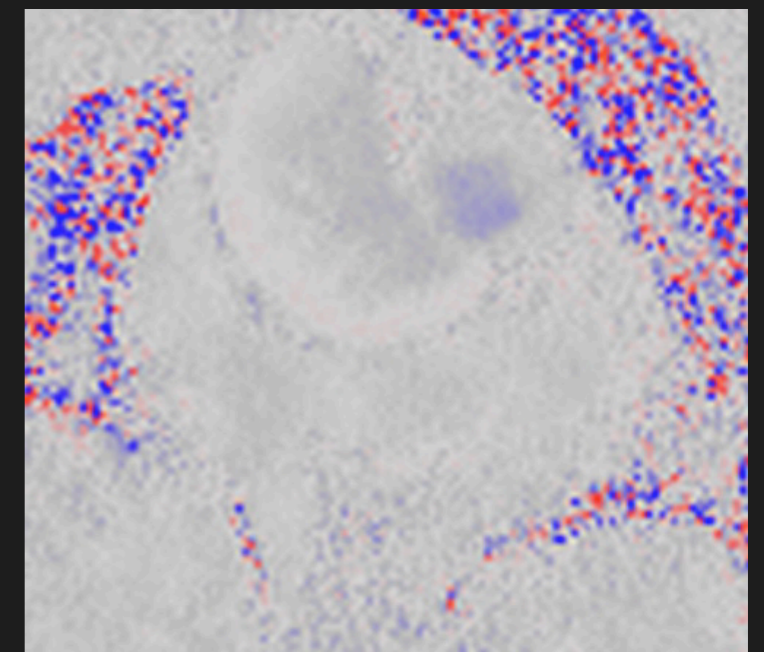
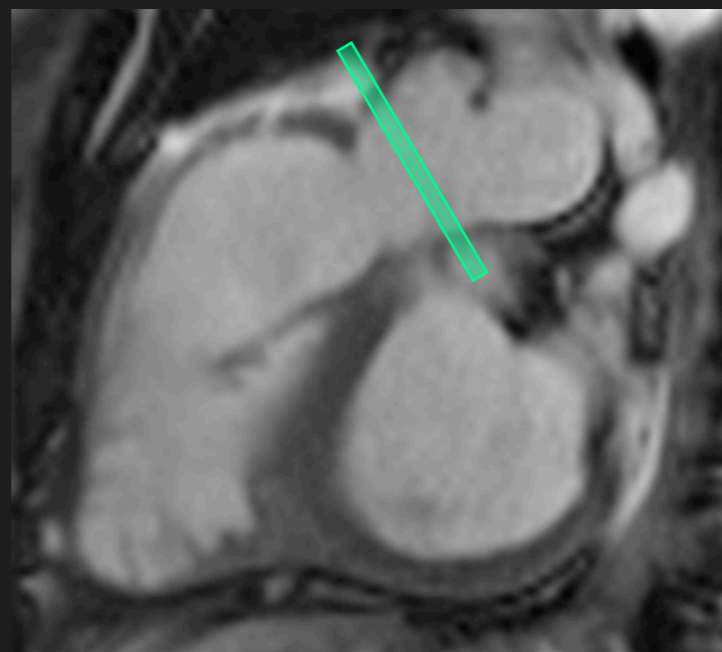
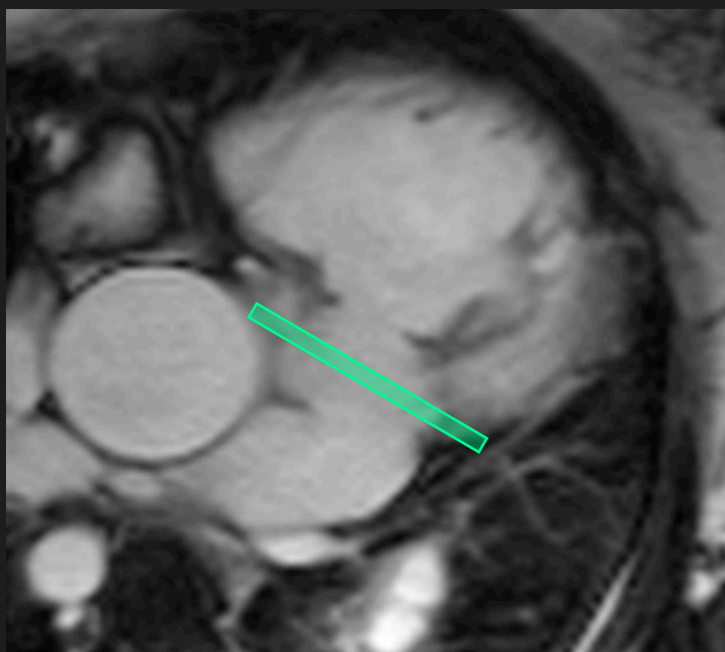

# Spatial resolution

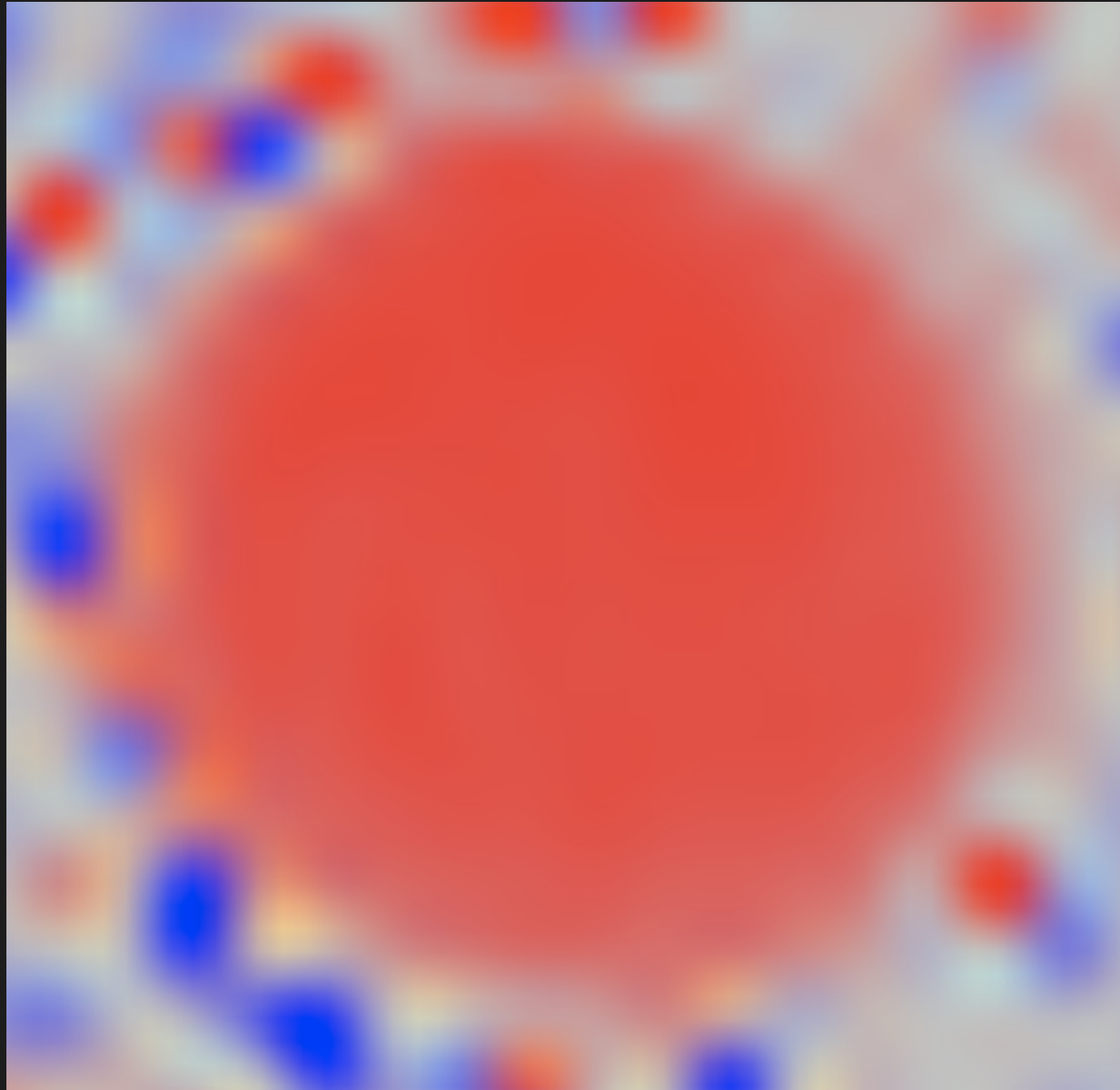

# Spatial resolution

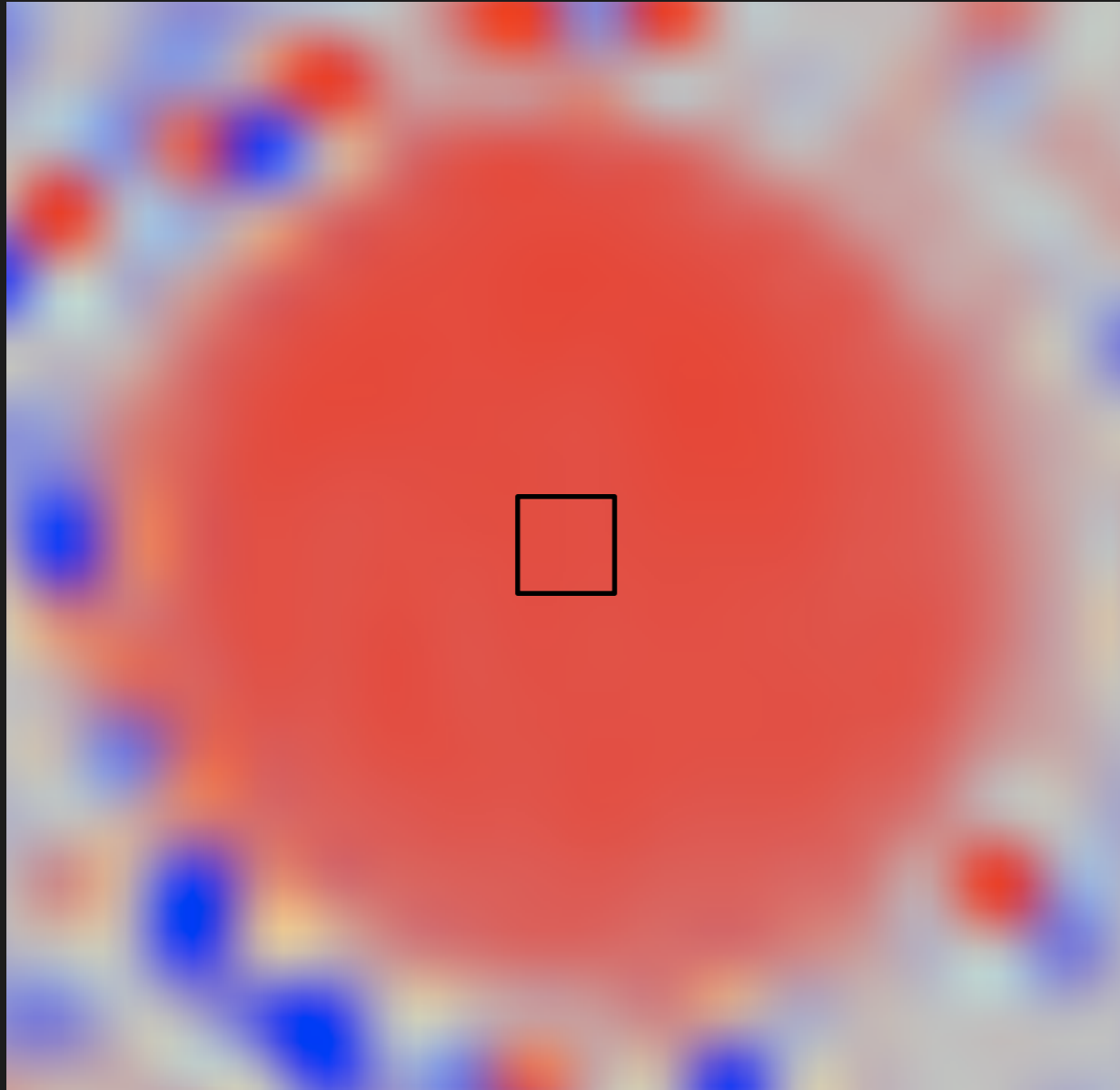

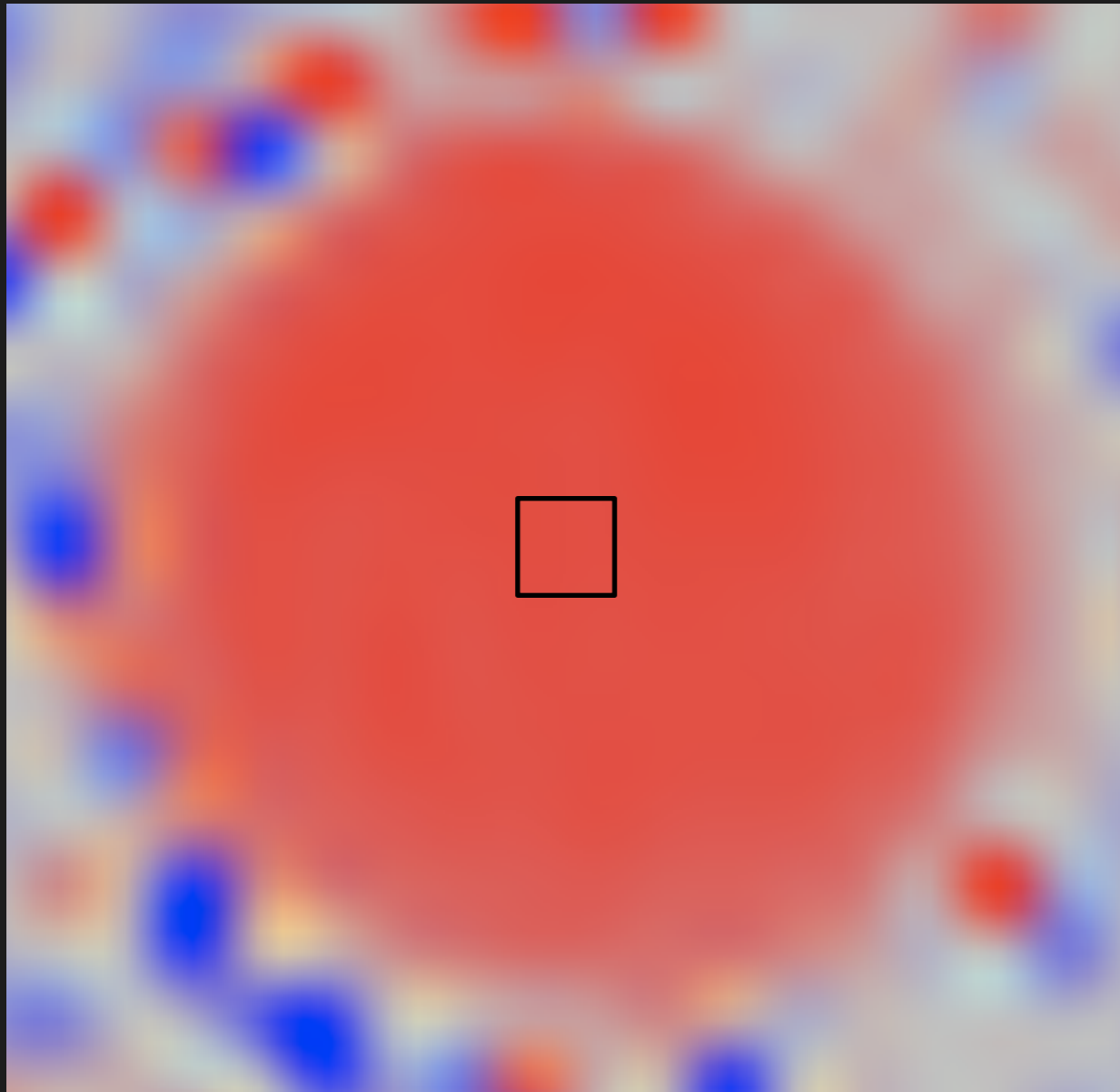

$$Q = V \times A$$

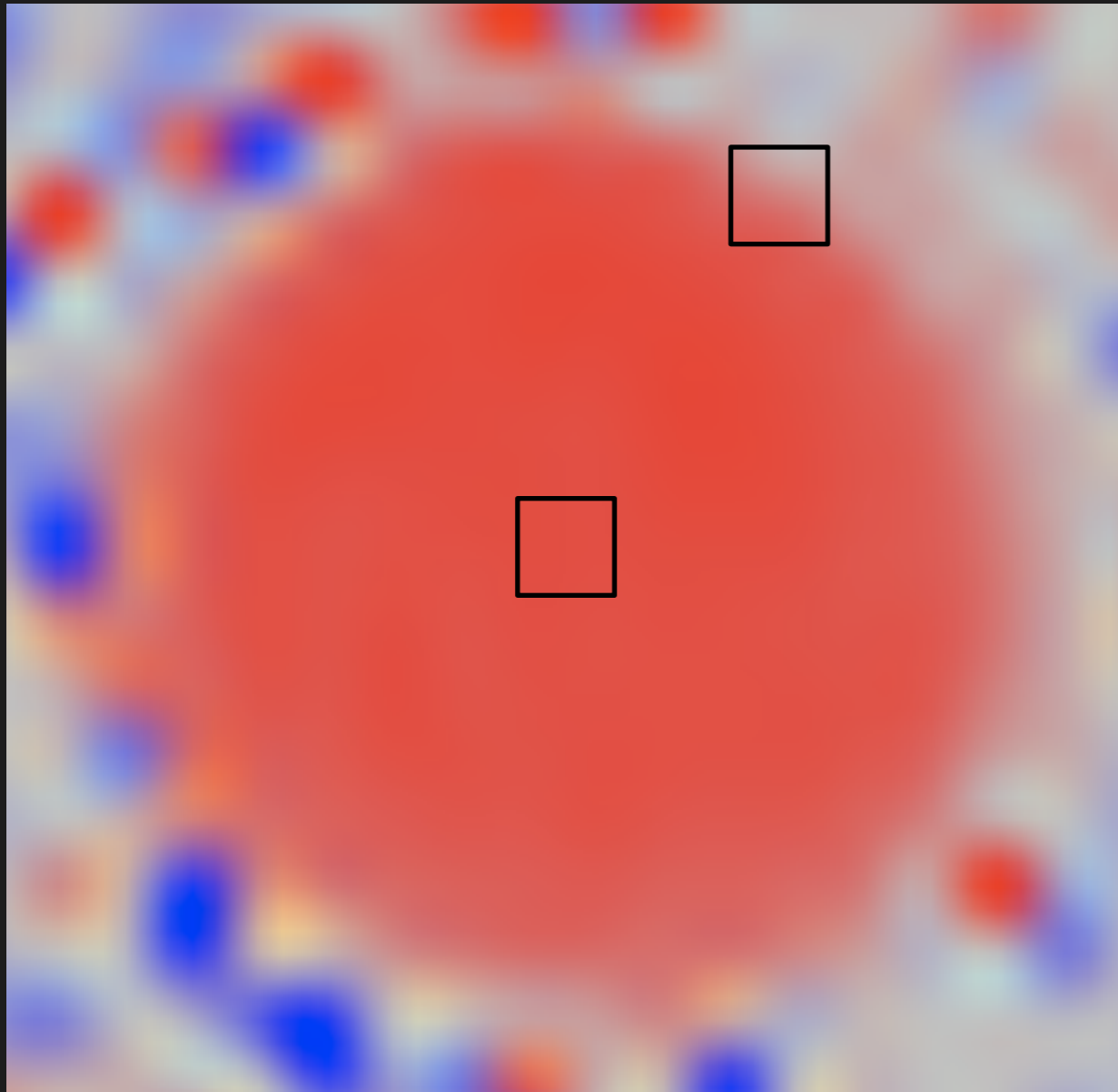

$$Q = V \times A$$

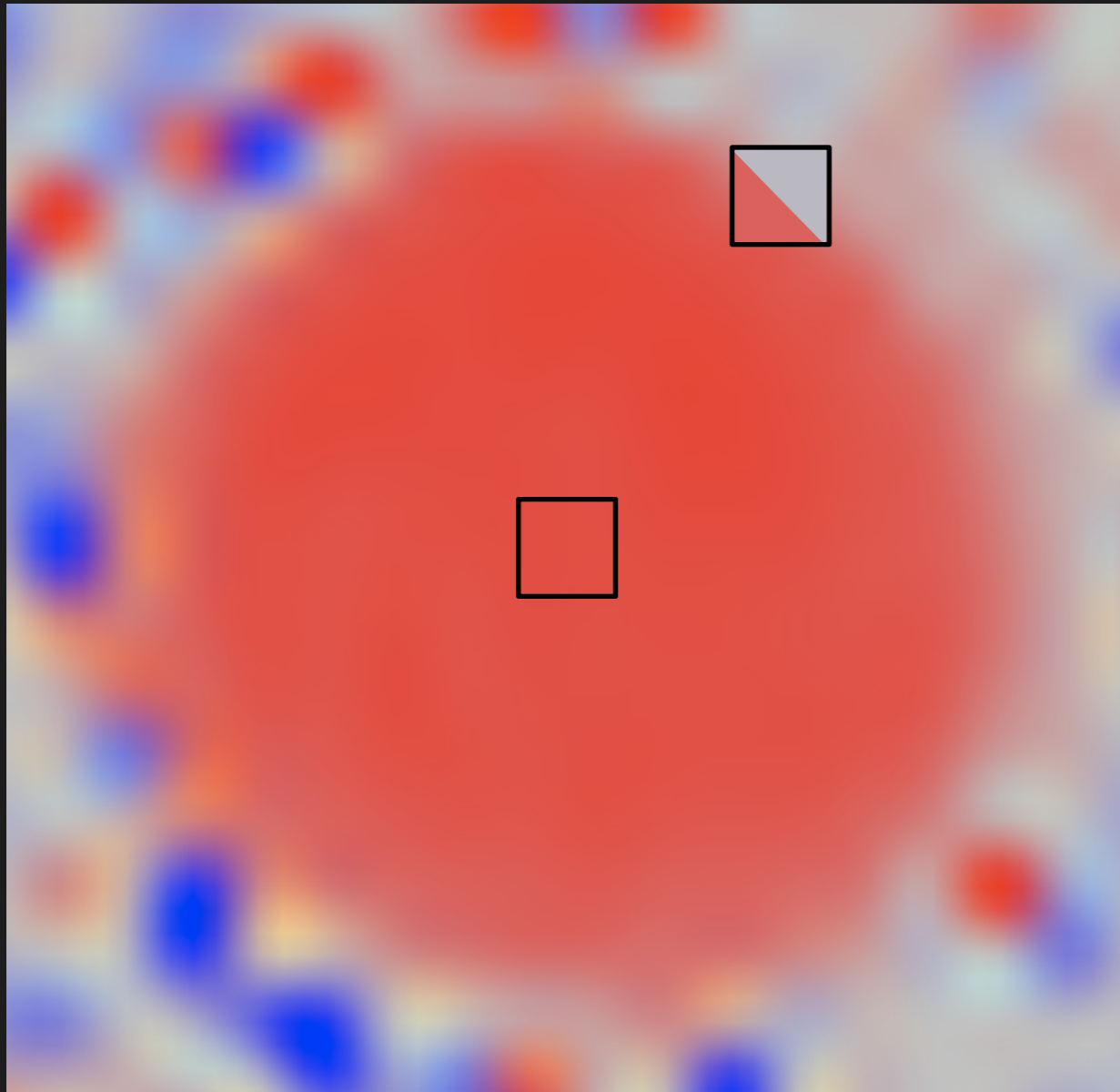

$$Q = V \times A$$

Half pixel moving

Half pixel stationary



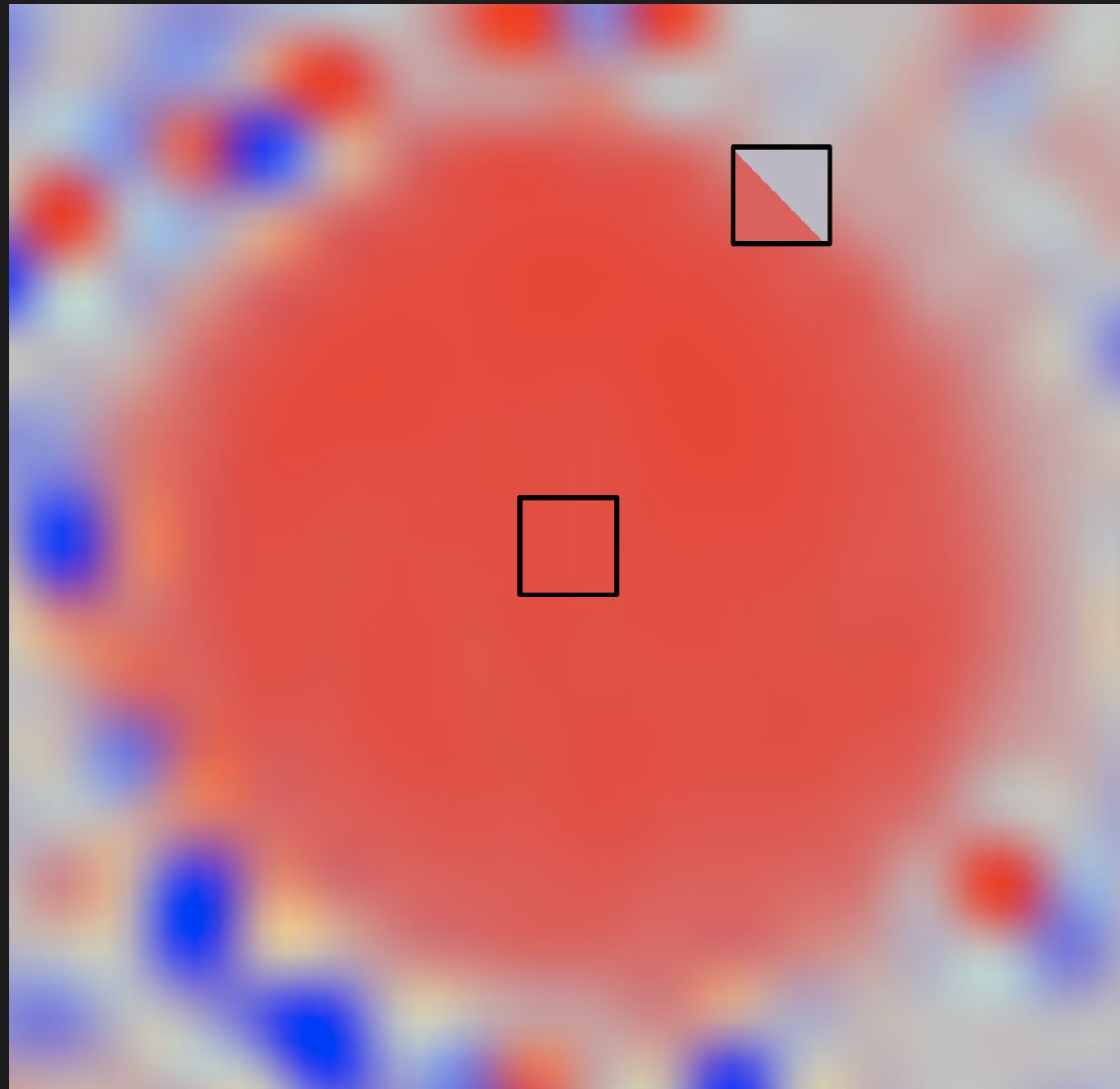

**Whats the flow**

$Q = V \times A$

Half pixel moving

Half pixel stationary

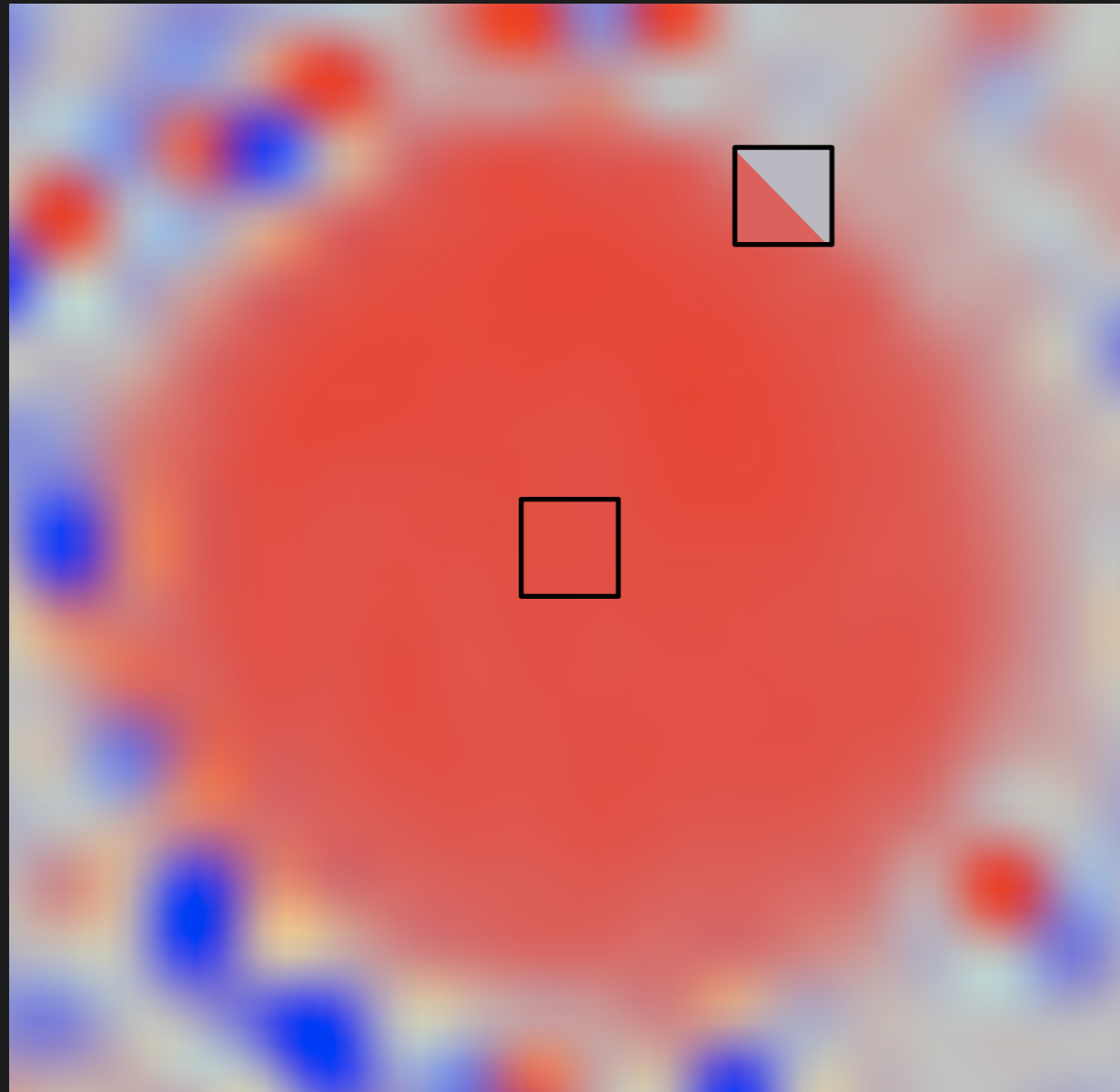

**Whats the flow**

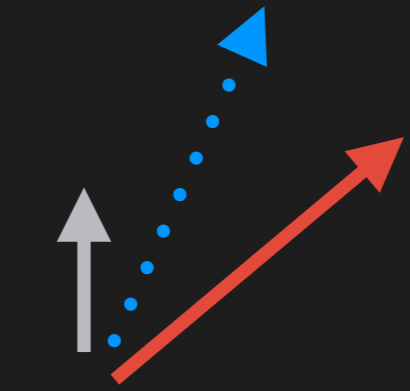

**Simple average**

**$Q = V \times A$**

**Half pixel moving**

**Half pixel stationary**

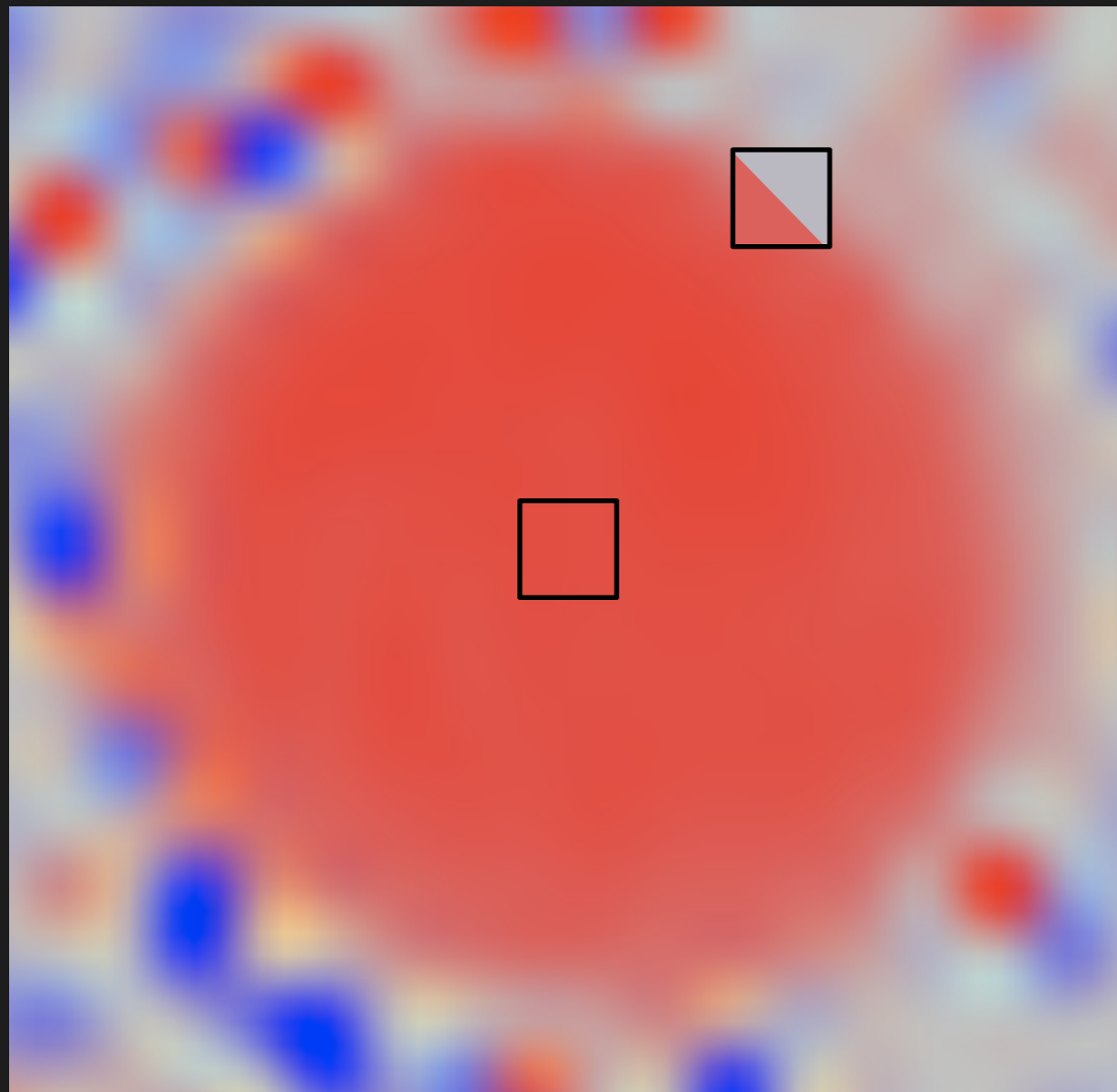

## Whats the flow

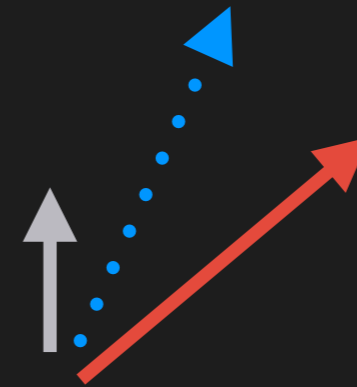

Simple  
average

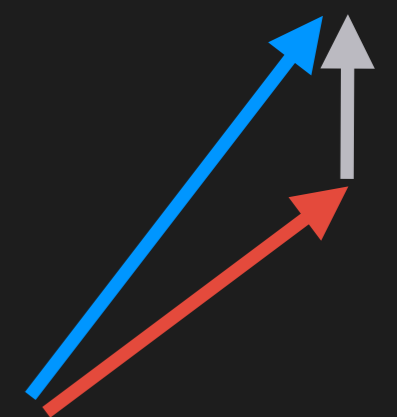

Vectorial  
sum

$$Q = V \times A$$

Half pixel moving

Half pixel stationary

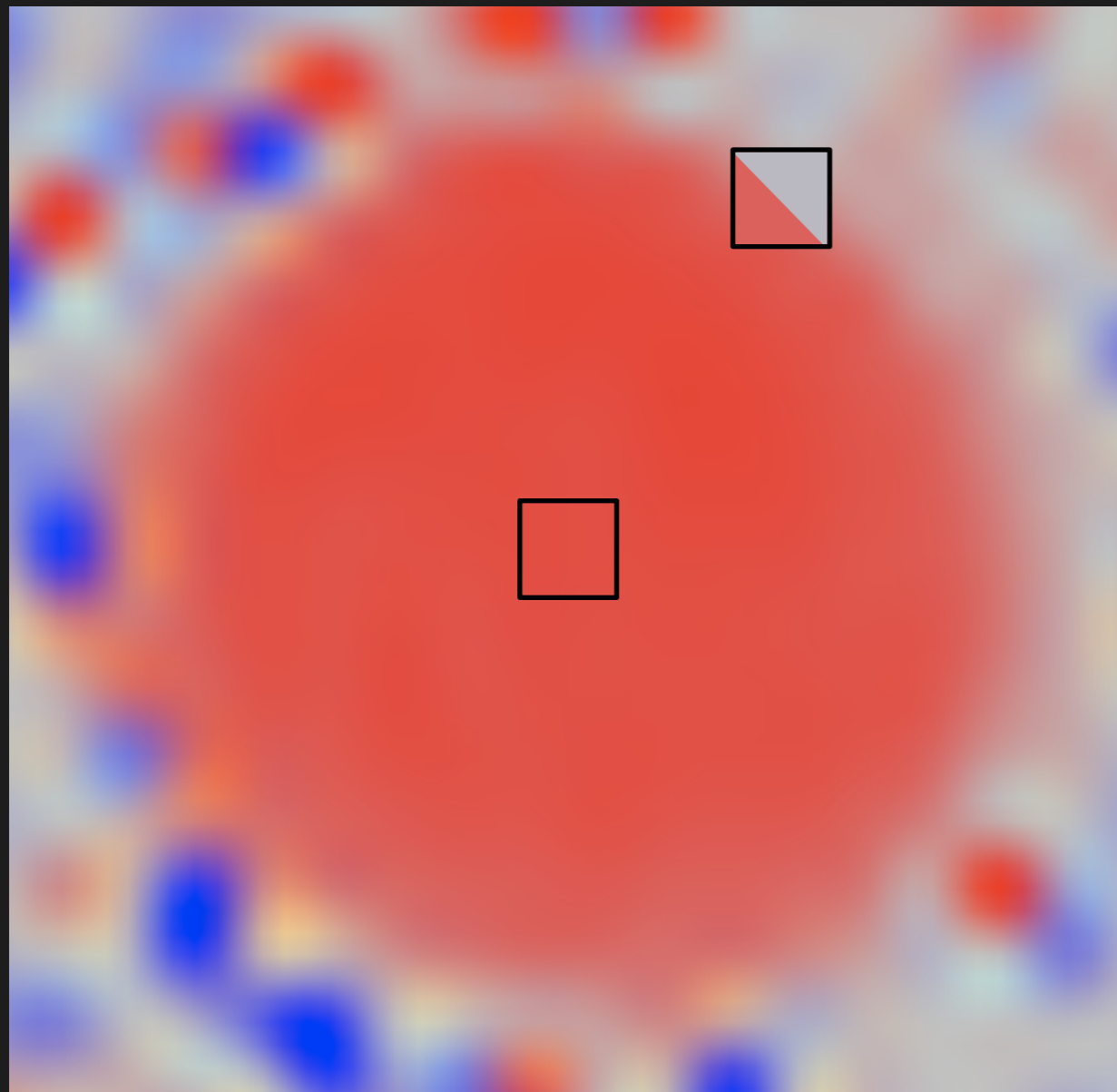

## Whats the flow

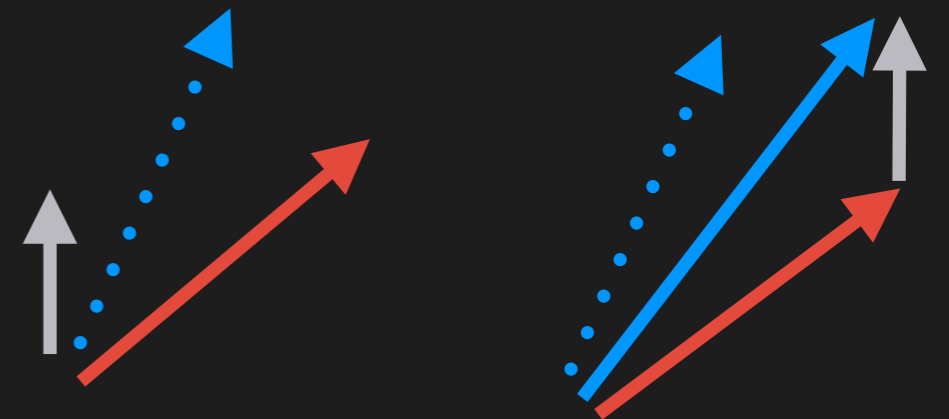

Simple  
average

Vectorial  
sum

$$Q = V \times A$$

Half pixel moving

Half pixel stationary

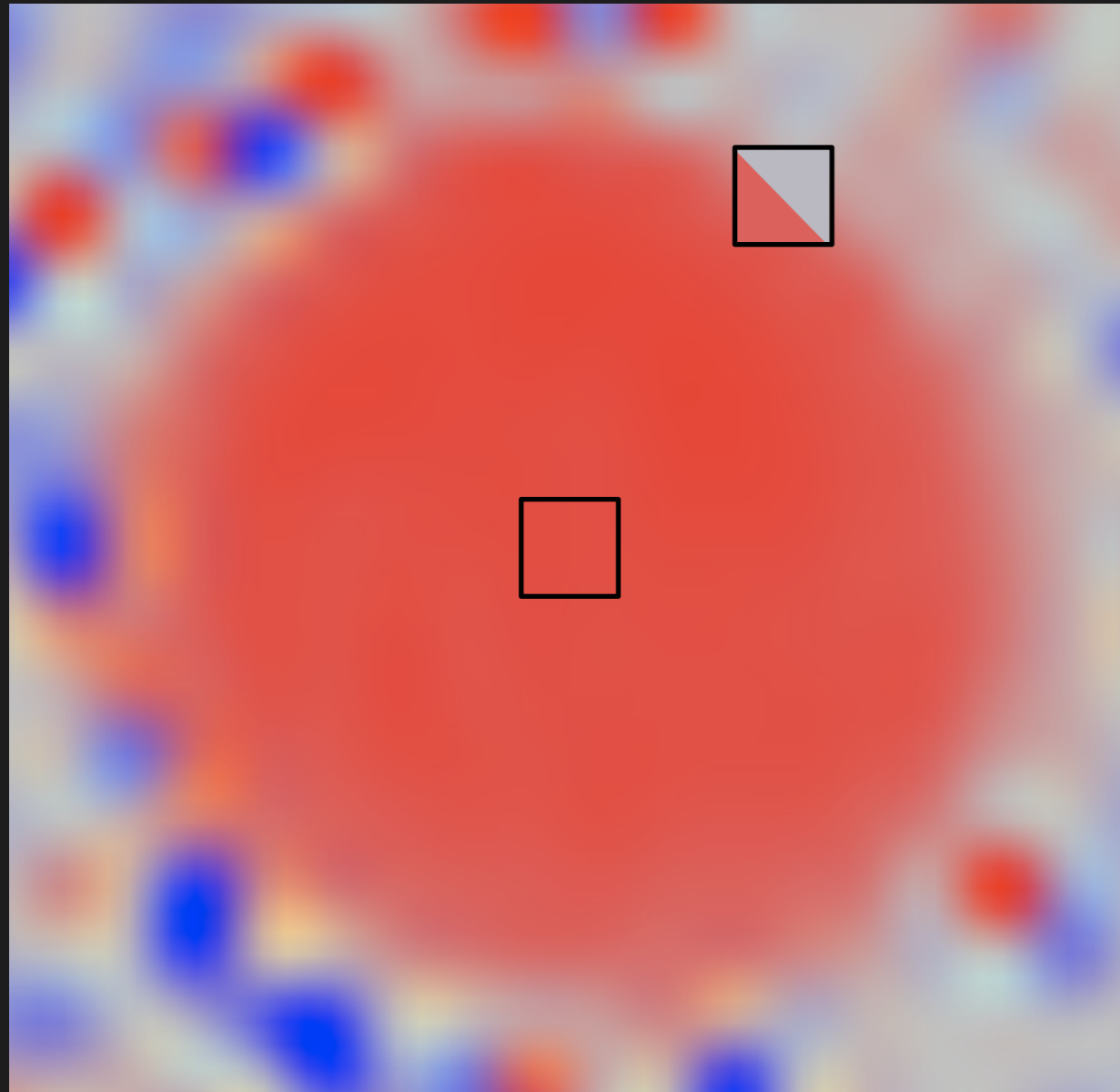

## Whats the flow

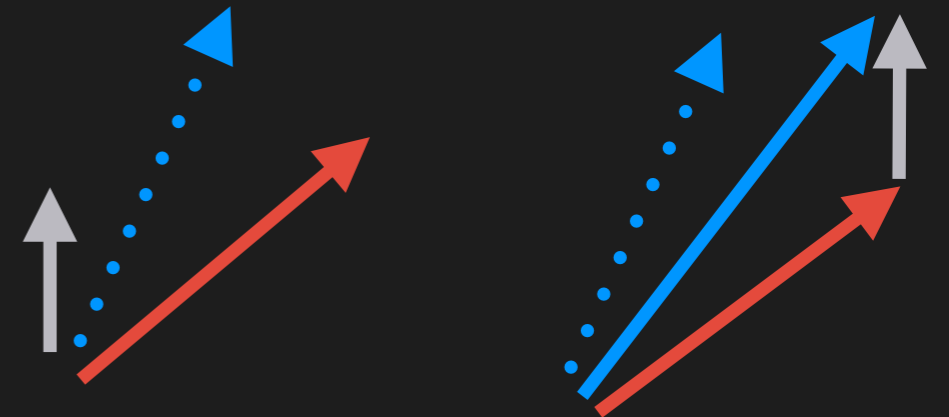

Simple  
average

Vectorial  
sum

## Edge pixels

$$Q = V \times A$$

Half pixel moving

Half pixel stationary

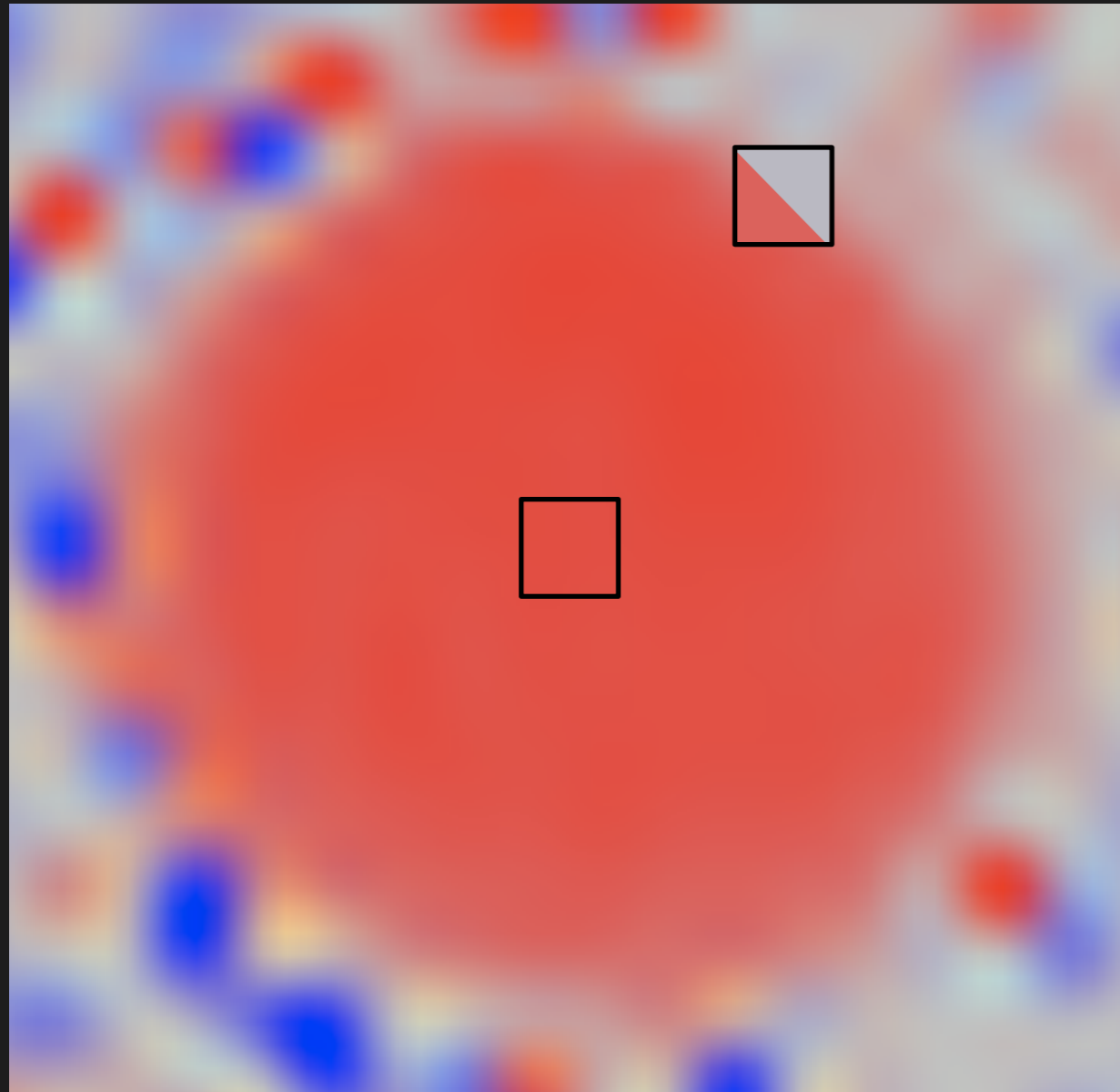

## Whats the flow

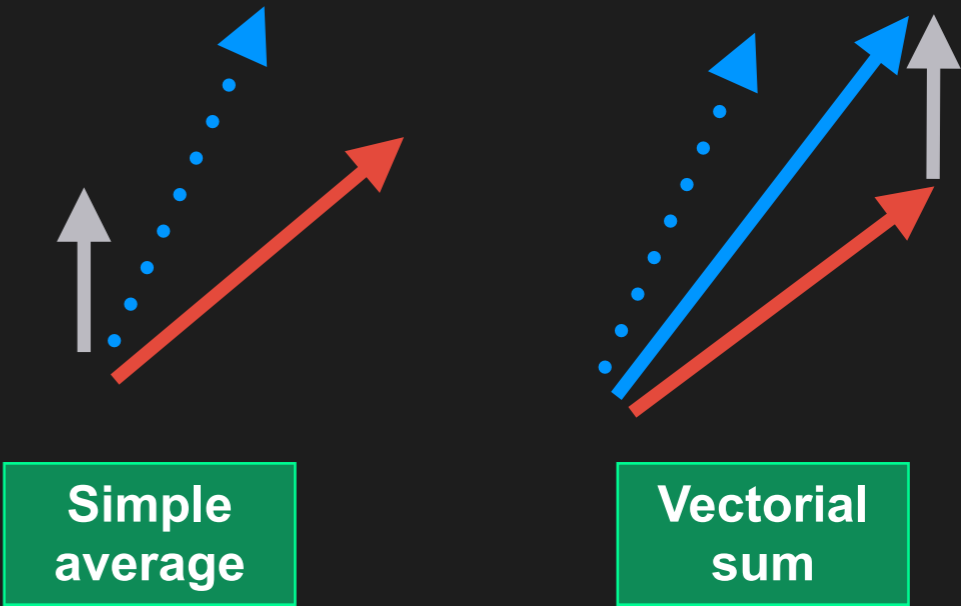

Simple average

Vectorial sum

## Edge pixels

Overestimate flow

$Q = V \times A$

Half pixel moving

Half pixel stationary

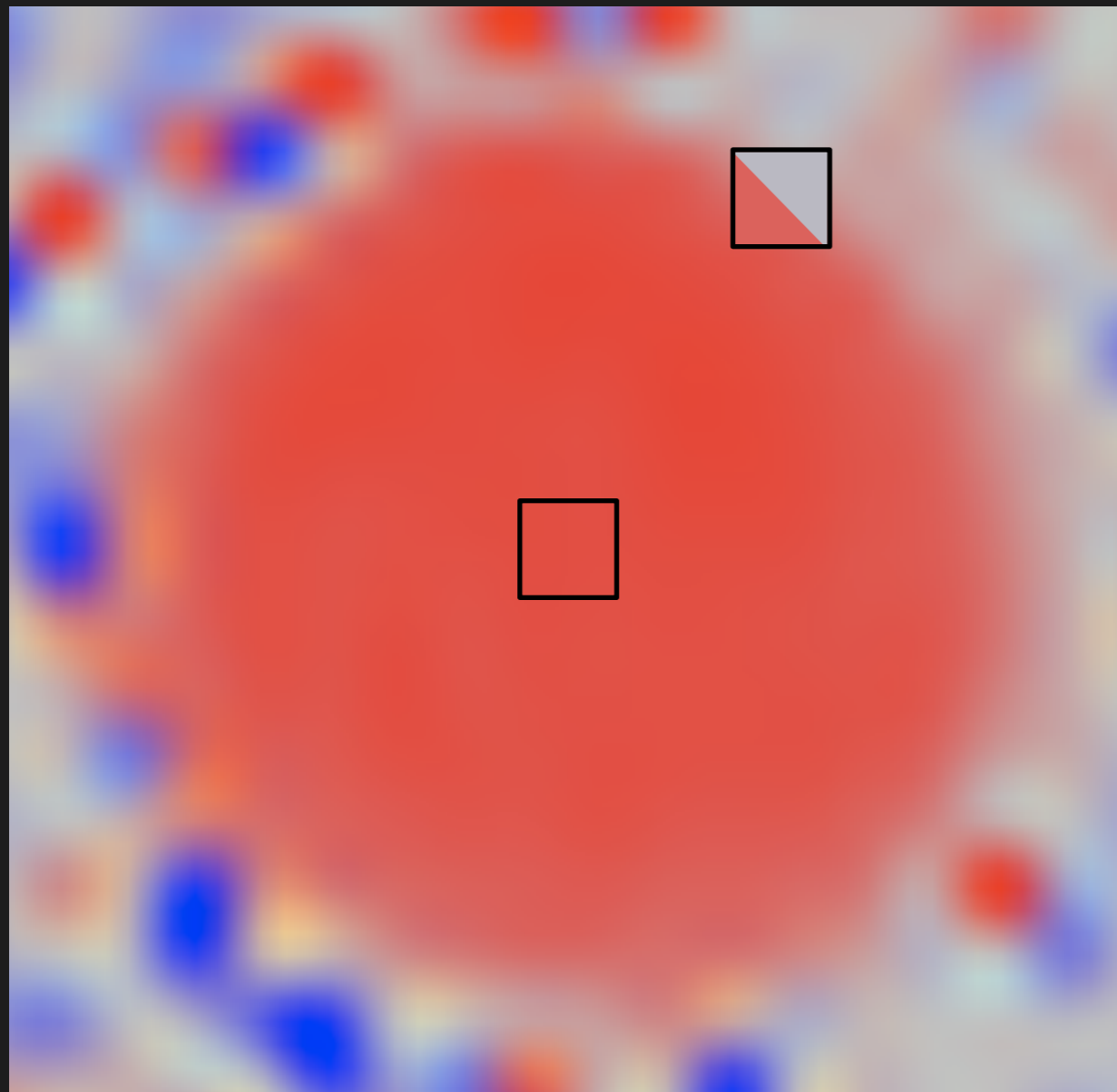

## Whats the flow

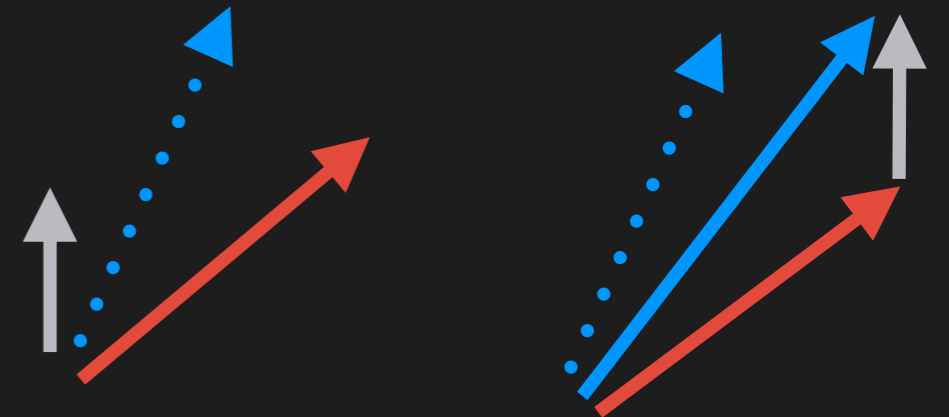

Simple  
average

Vectorial  
sum

## Edge pixels

Overestimate flow

16 pixels minimum

$$Q = V \times A$$

Half pixel moving

Half pixel stationary





**No. of frames**

No. of frames

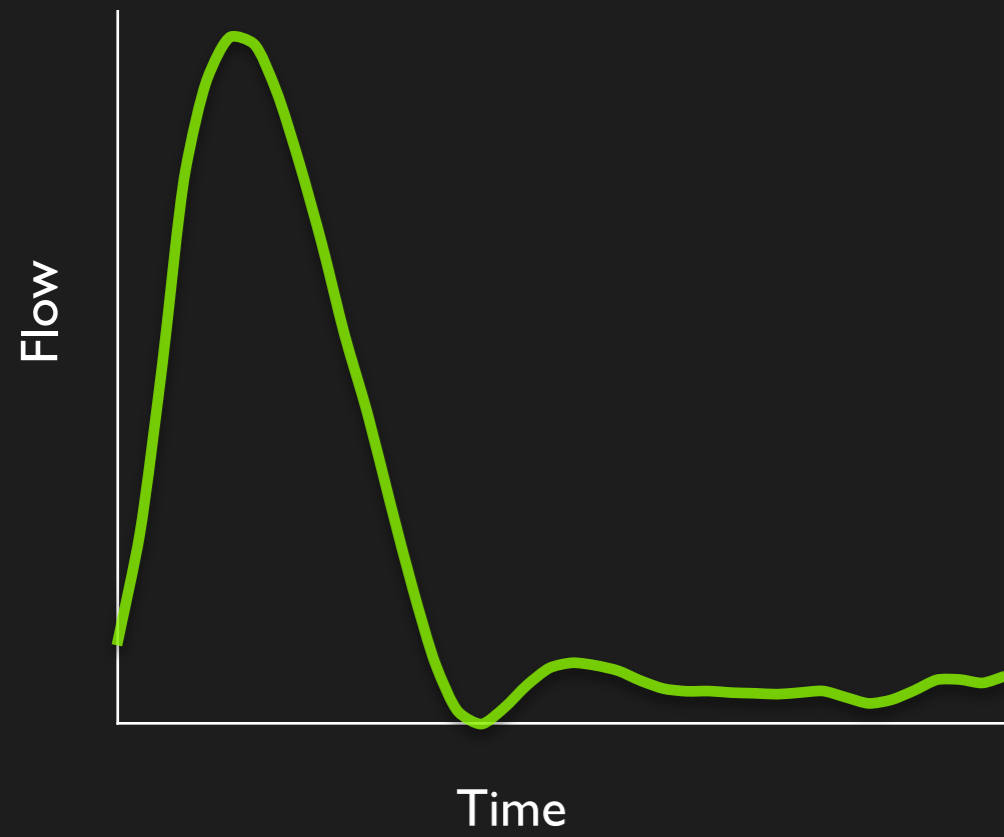

No. of frames

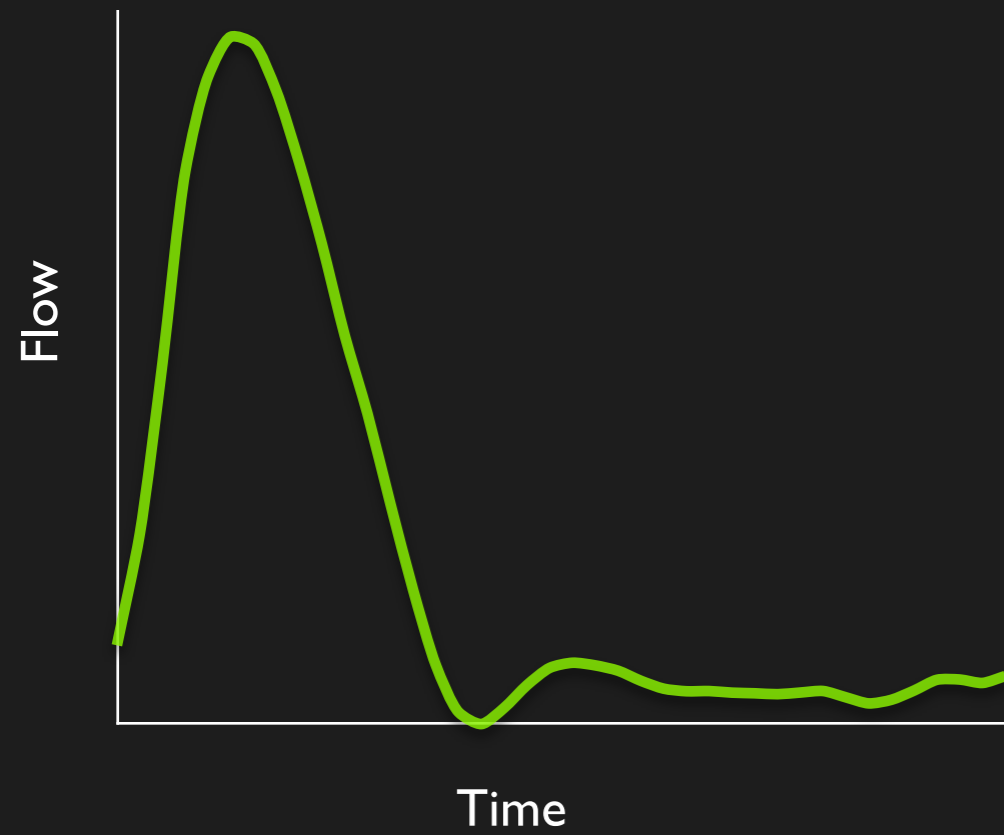

Accuracy of features

No. of frames

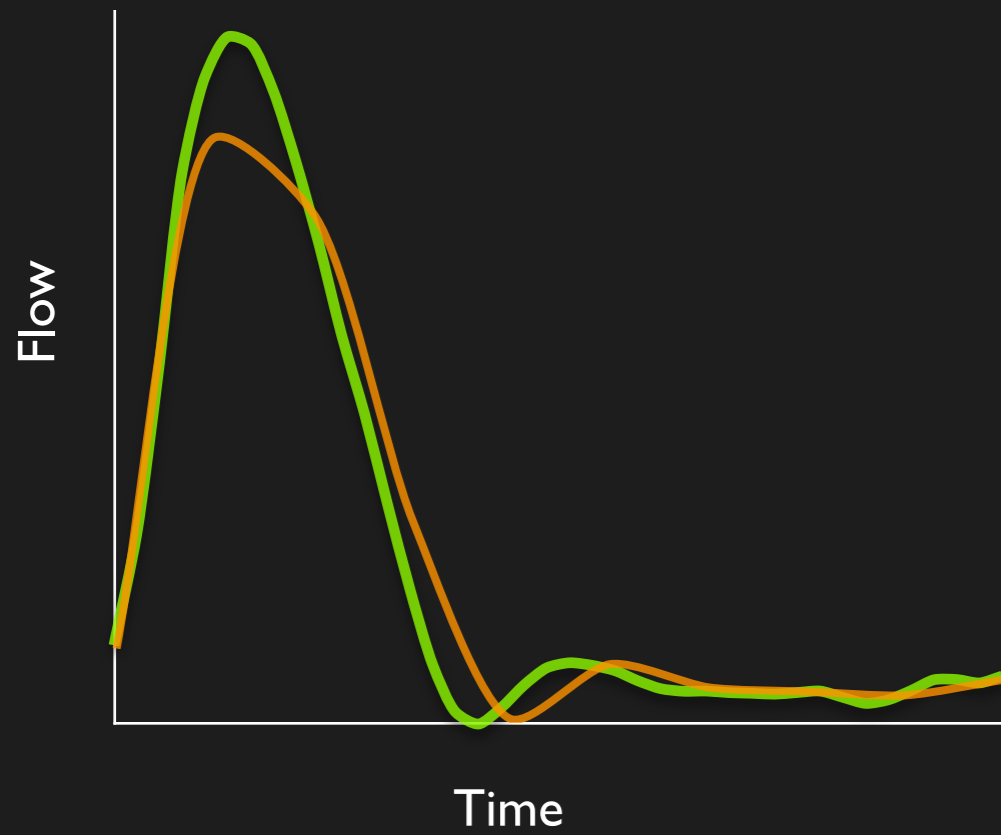

Accuracy of features

Blurred curve

No. of frames

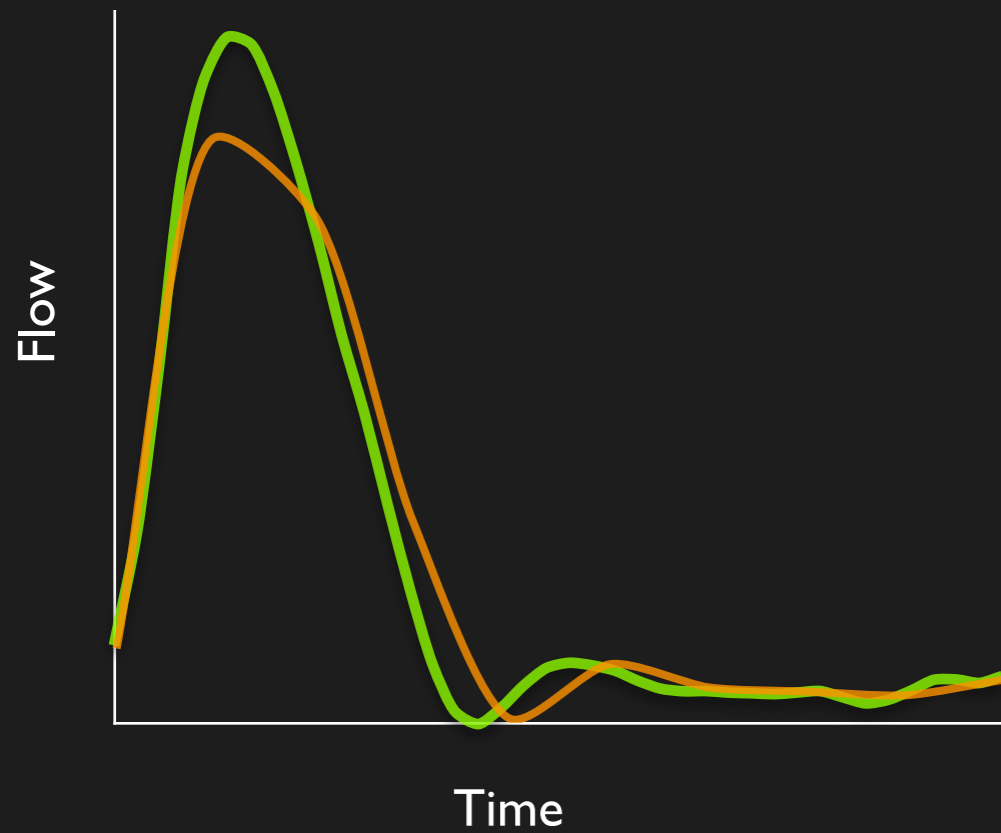

Accuracy of features

Blurred curve

Does it matter

No. of frames

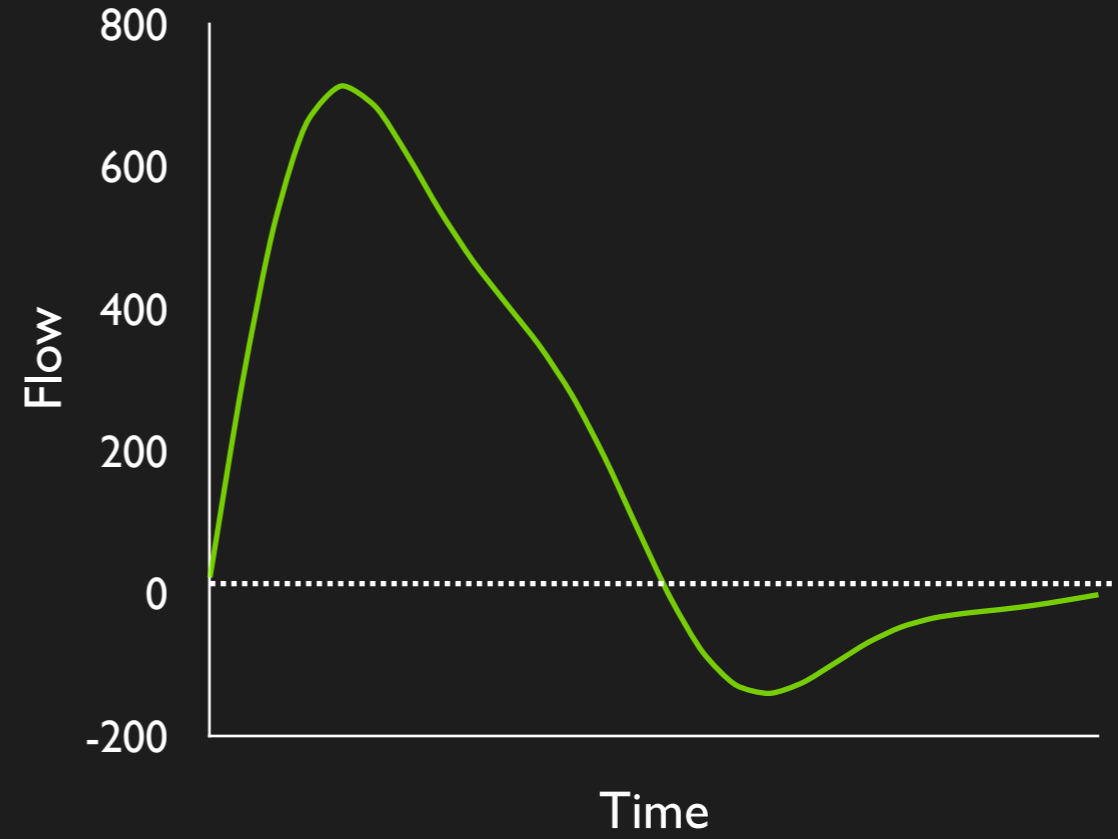
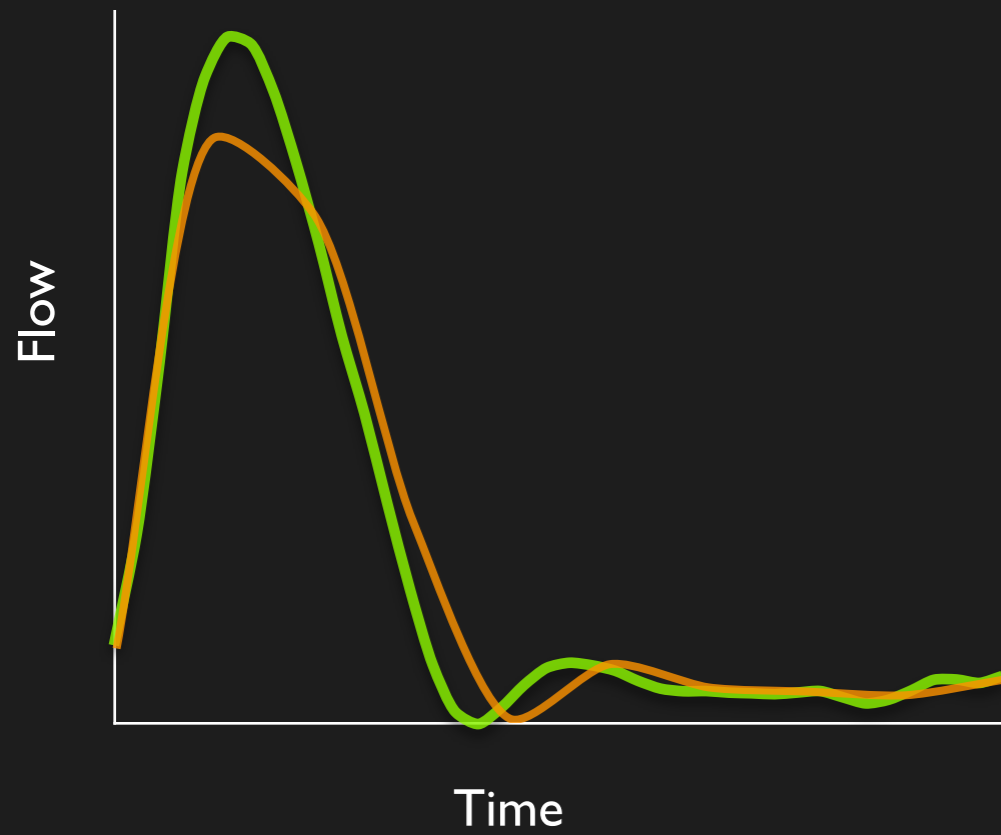

Accuracy of features

Blurred curve

Does it matter

No. of frames

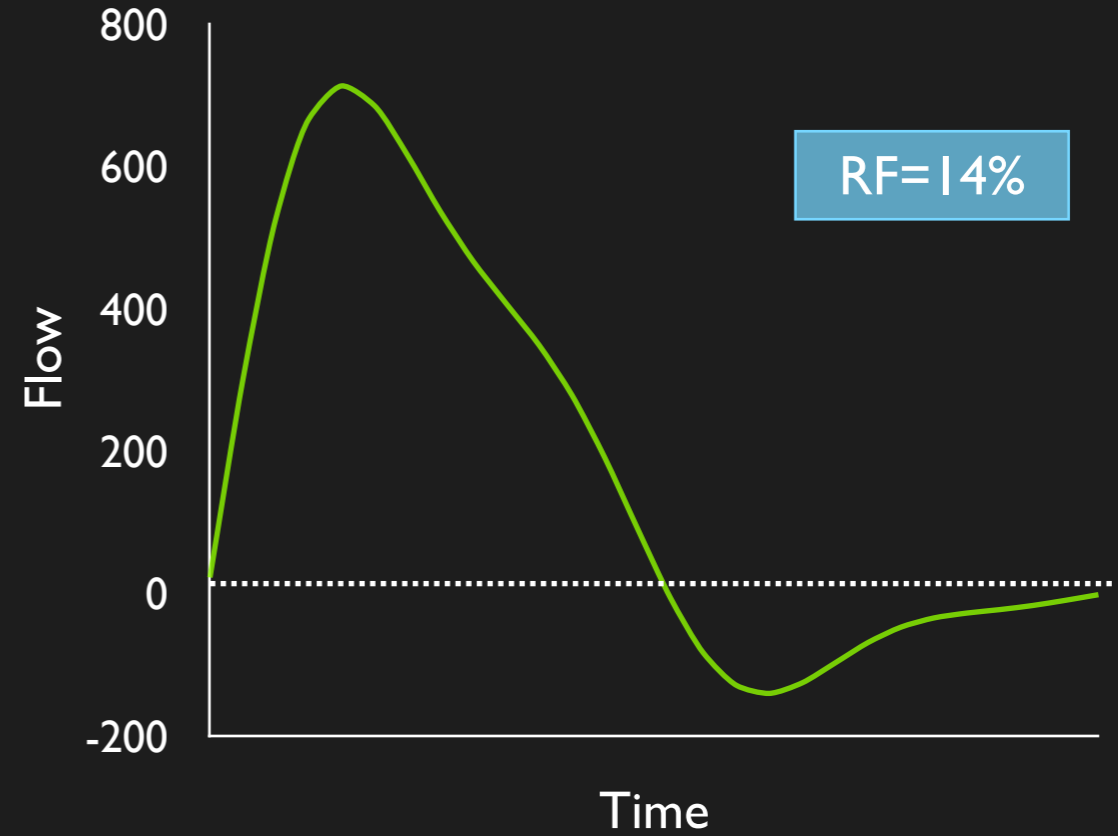
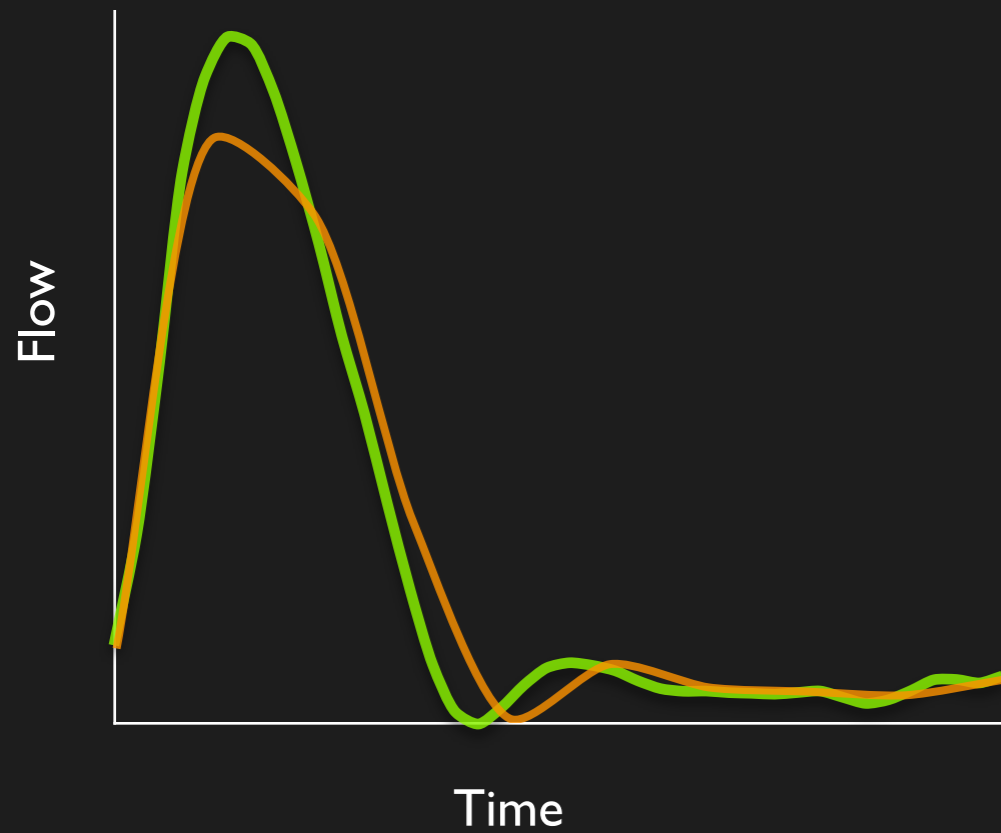

Accuracy of features

Blurred curve

Does it matter

No. of frames

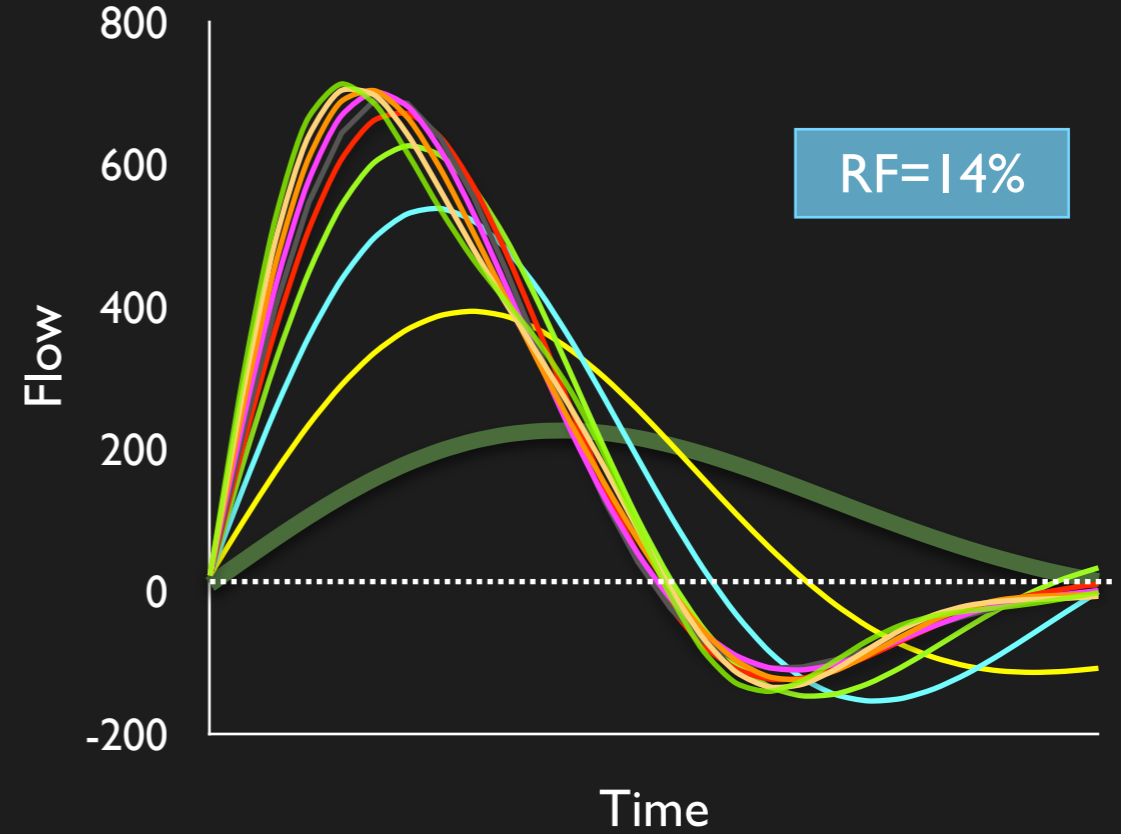
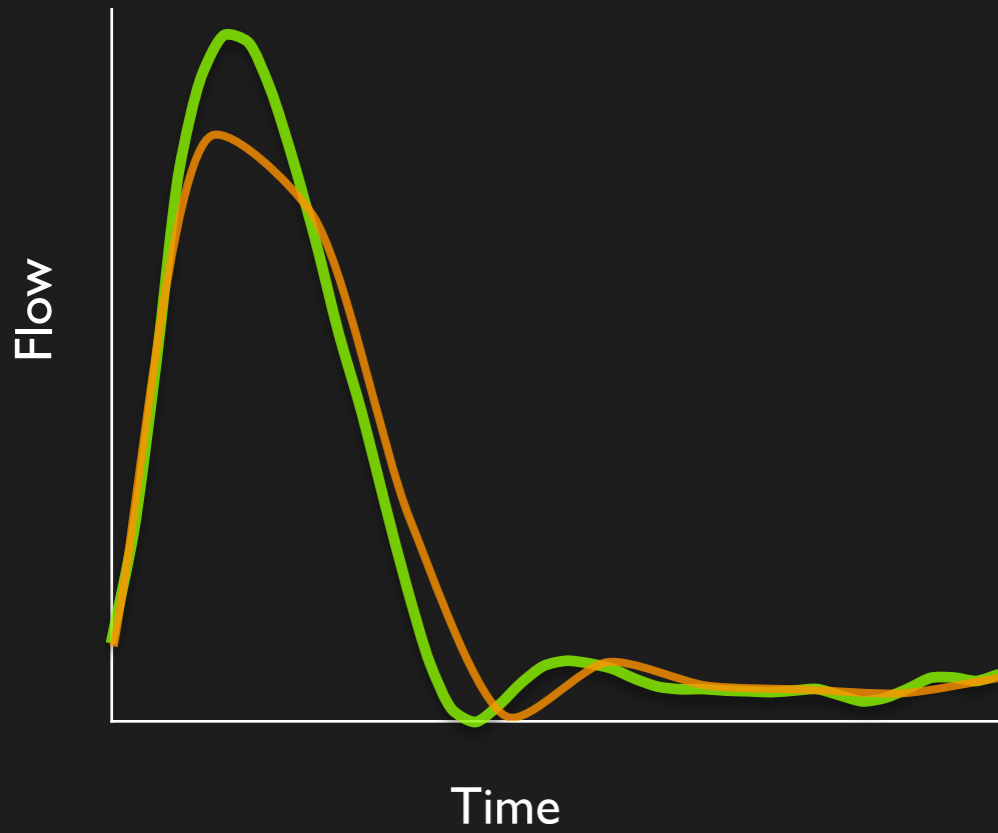

Accuracy of features

Blurred curve

Does it matter



No. of frames

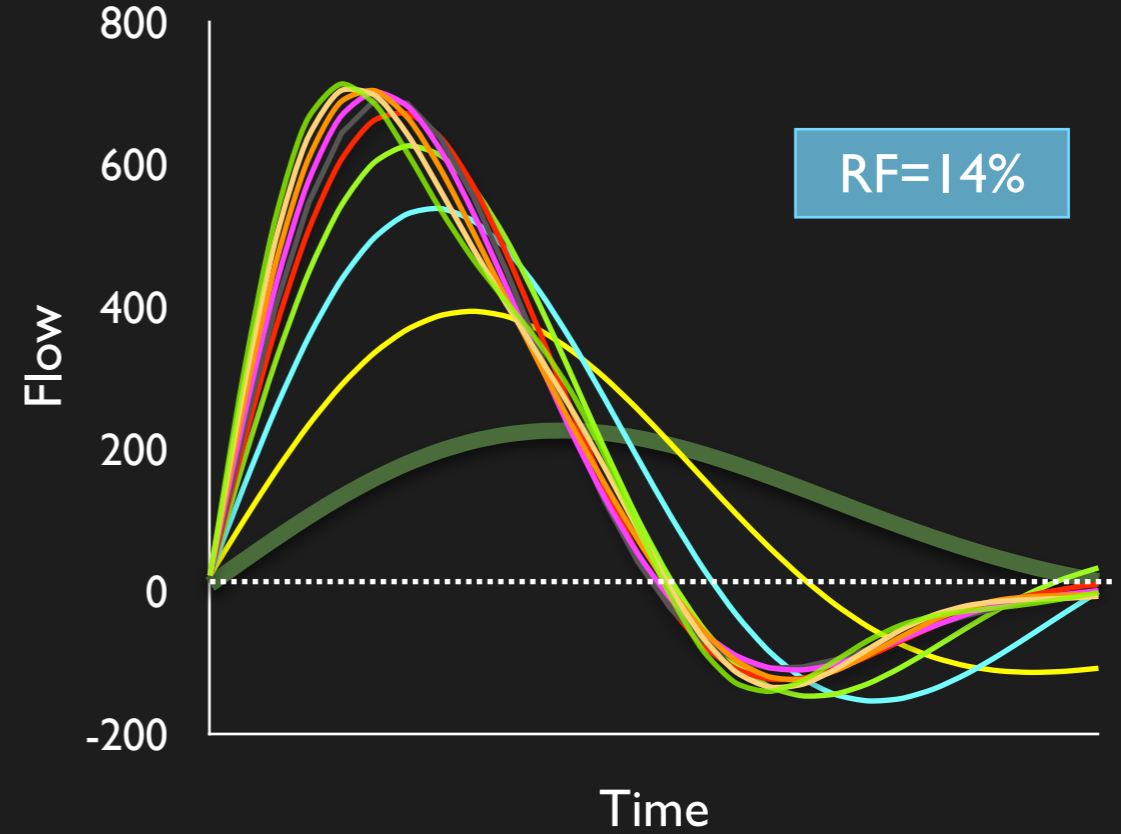
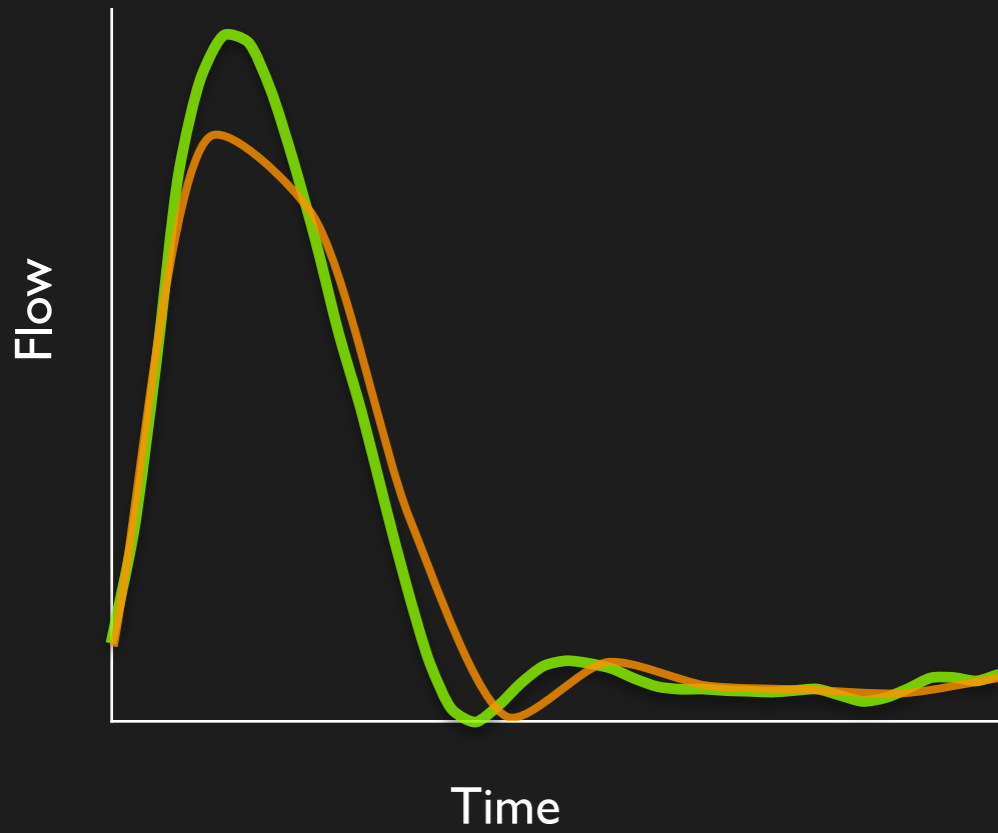

Accuracy of features

Blurred curve

Does it matter

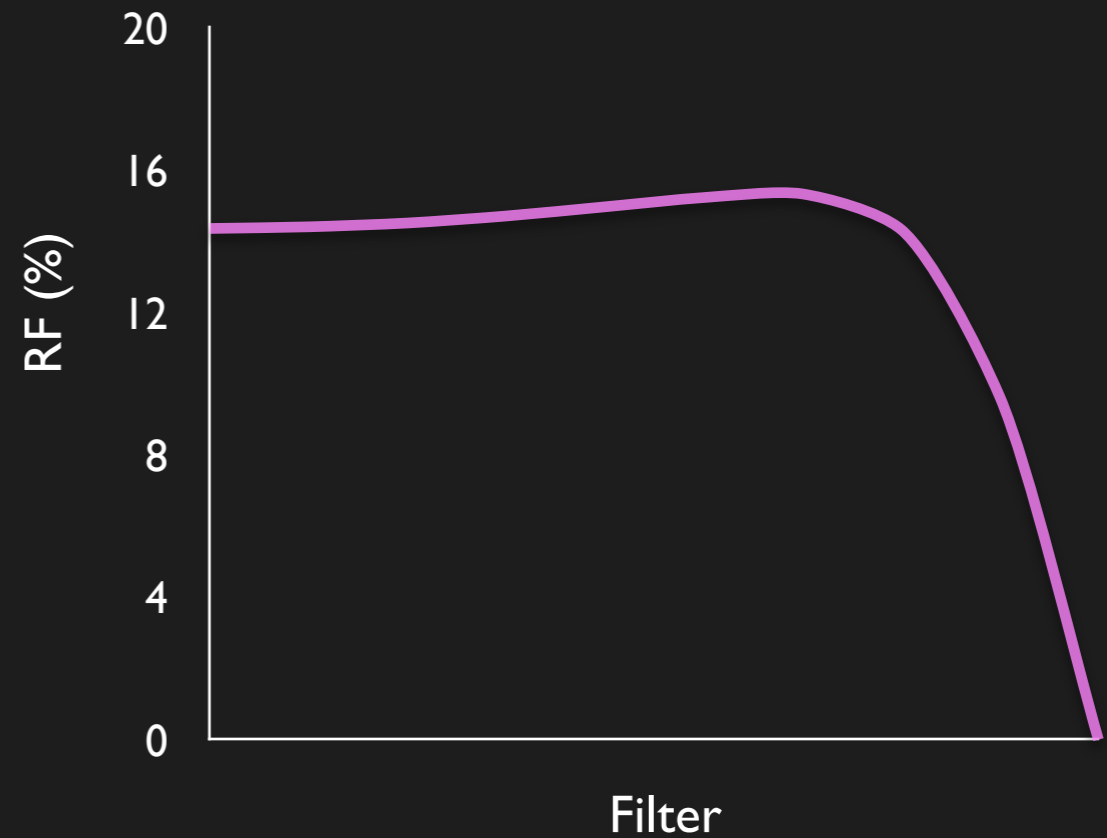

In silico model

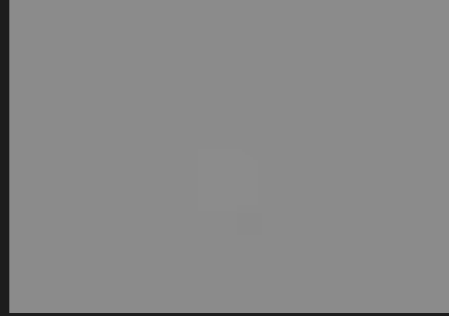

In silico model



In silico model



50 fps

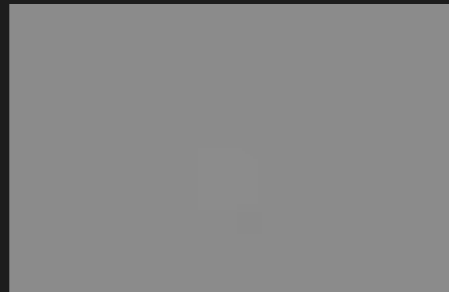

In silico model



50 fps

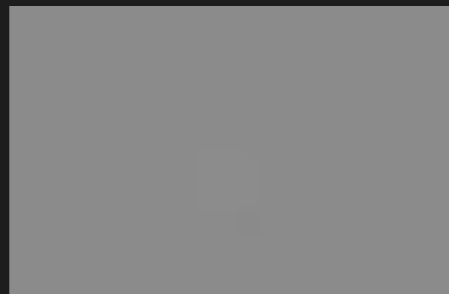

10 fps



In silico model

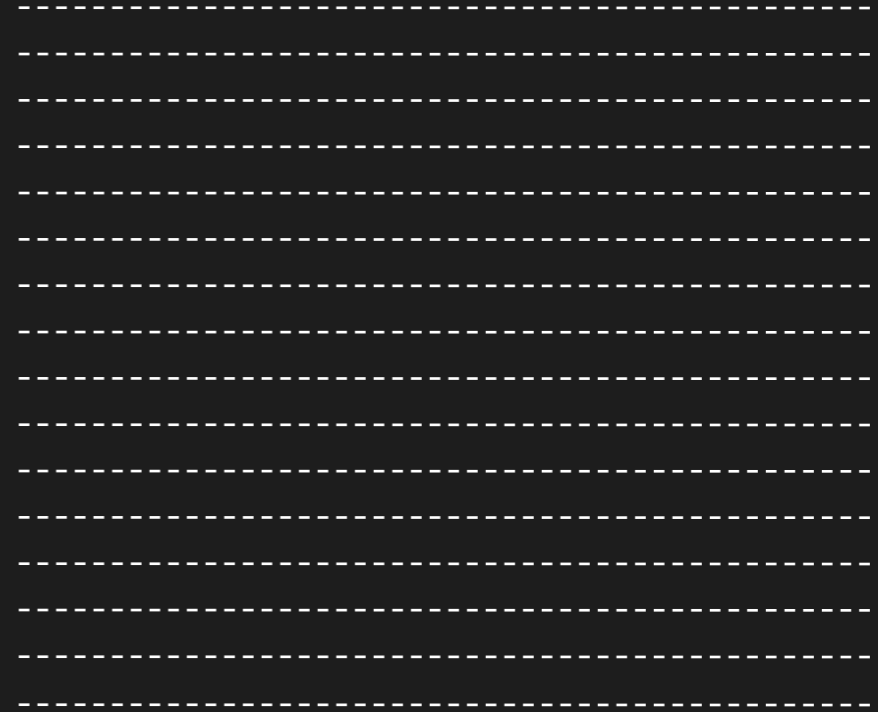

50 fps

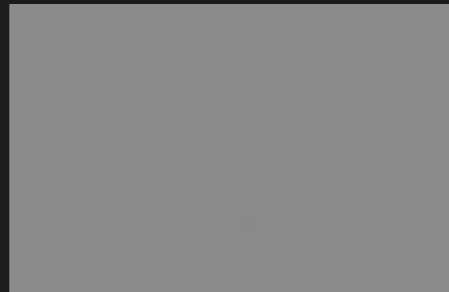

10 fps

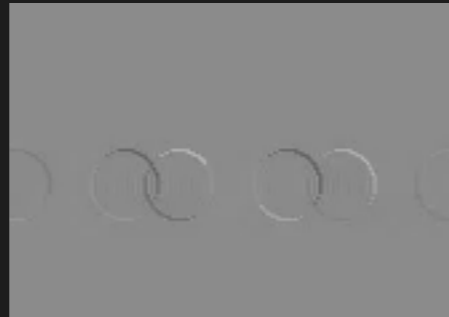

In silico model

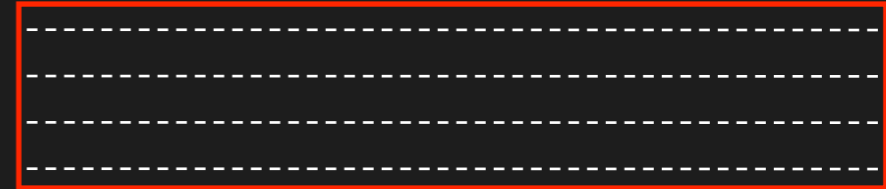

50 fps



1 segment per RR

10 fps

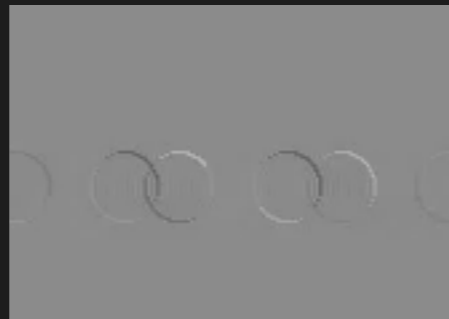

In silico model



50 fps

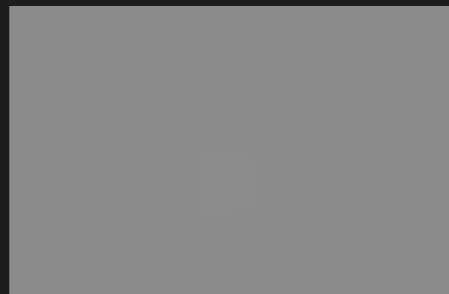

10 fps



1 segment per RR



In silico model



50 fps



10 fps



1 segment per RR

$LPS \times TR$ - temporal res

In silico model



50 fps



10 fps



1 segment per RR

$LPS \times TR$ - temporal res

Acquisition time

In silico model



50 fps

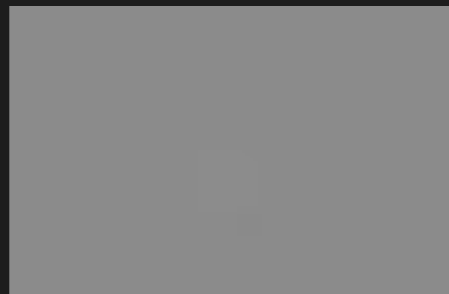

10 fps



1 segment per RR

$LPS \times TR$ - temporal res

Acquisition time

Retrospective gating

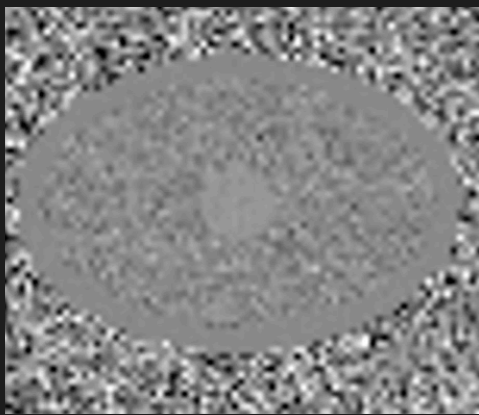
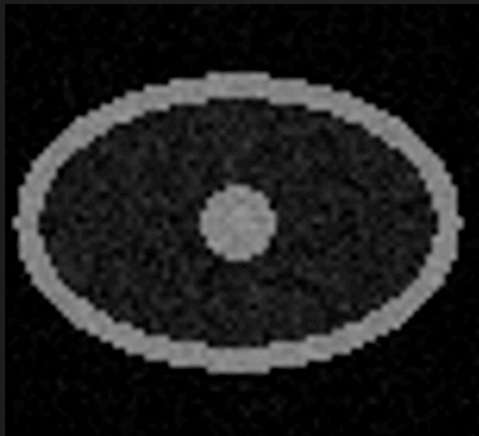
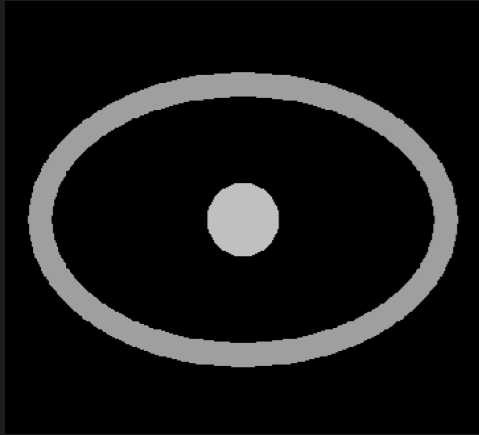

**No artefact**

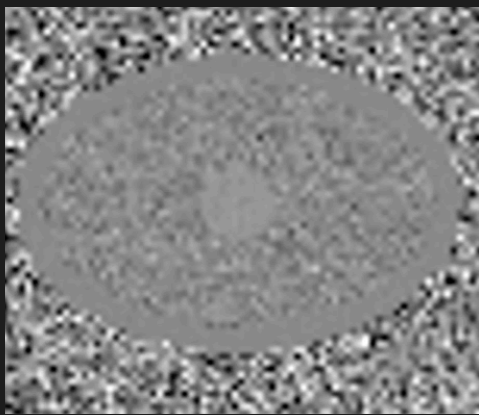
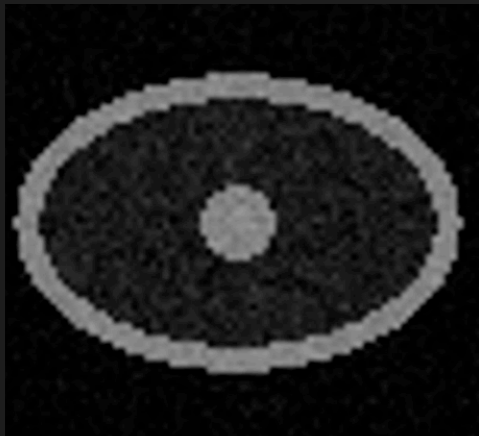
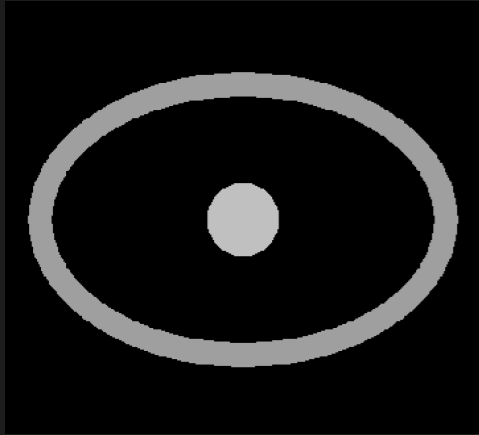

**No artefact**

# Breathing

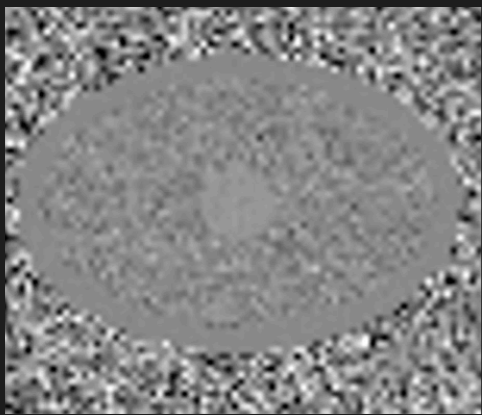
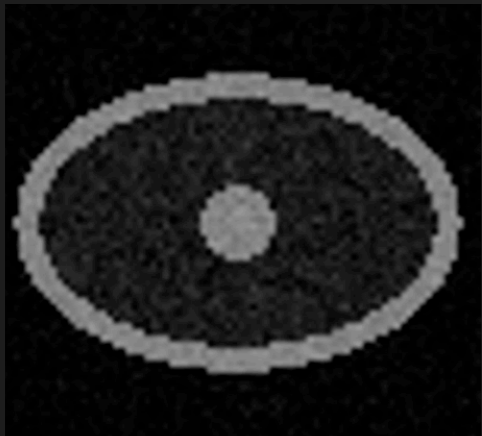
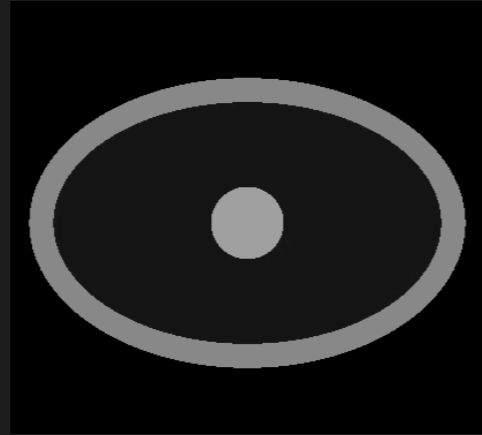
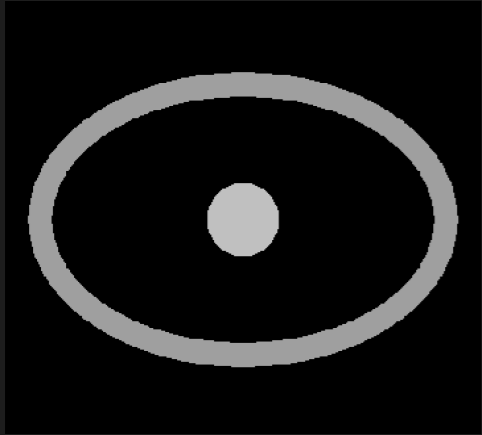

**No artefact**

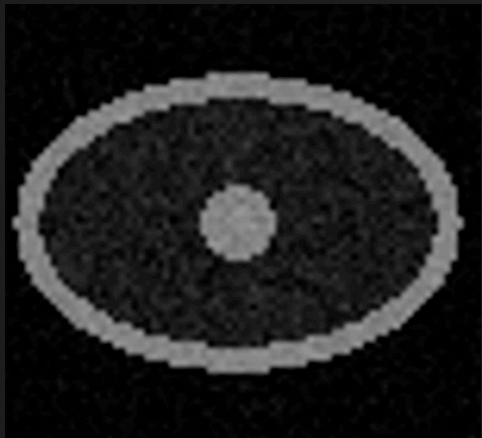
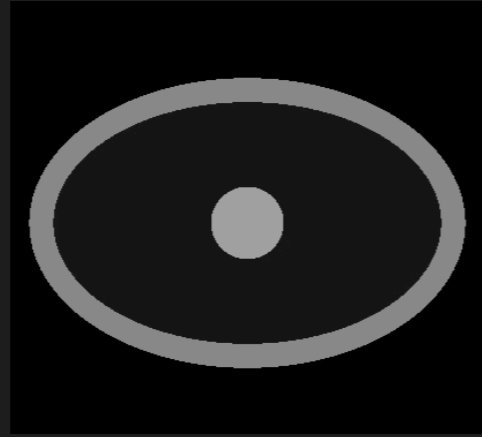
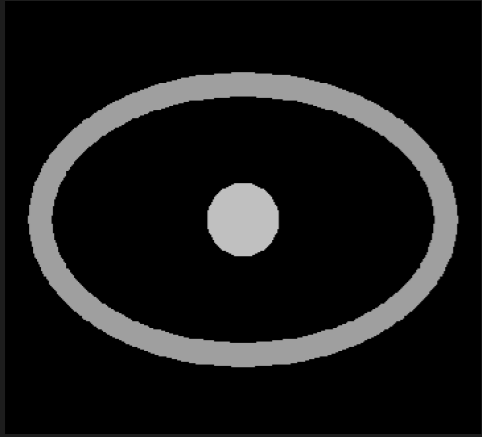

**No artefact**

**Ghosting**

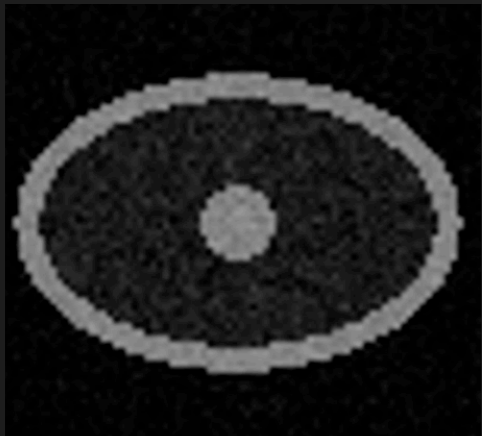
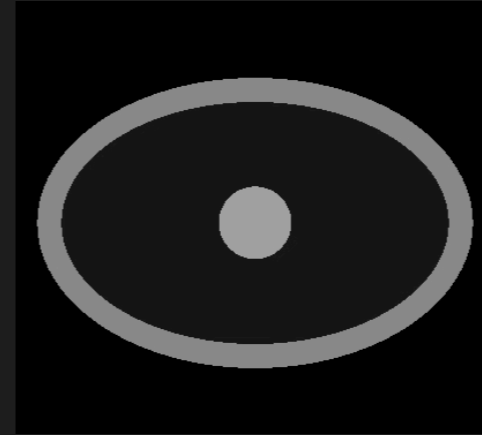
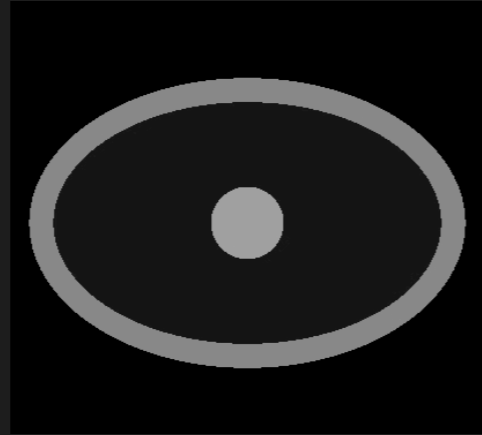
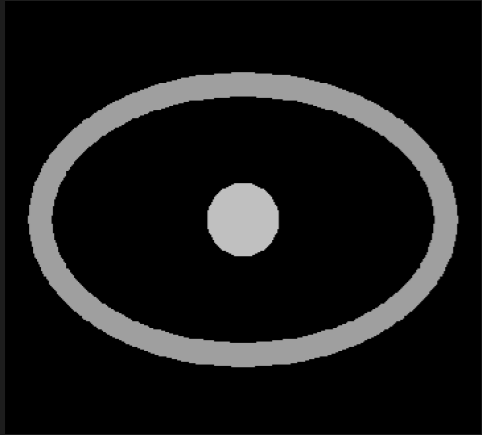

**No artefact**

**Ghosting**



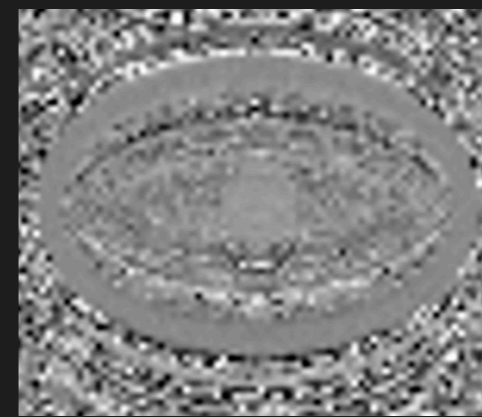
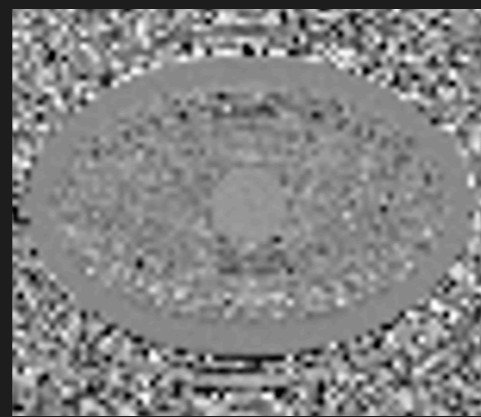
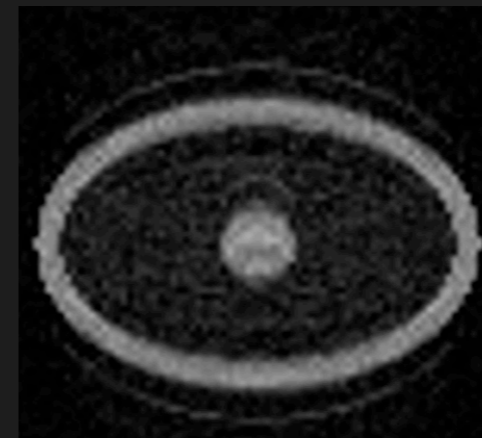
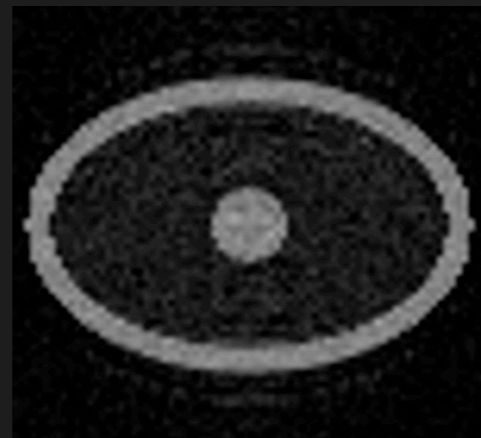
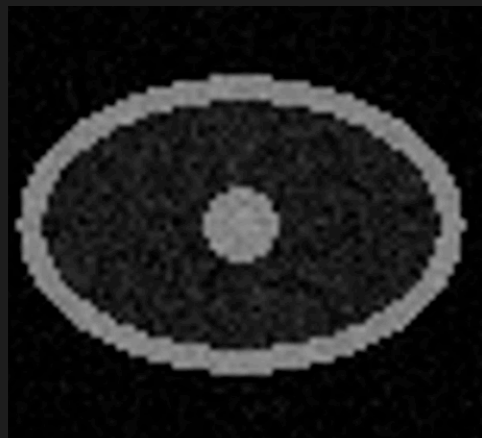
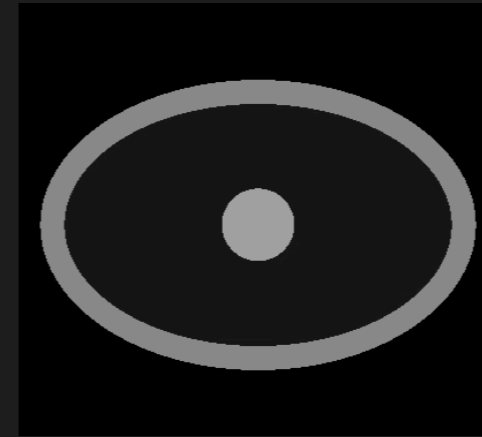
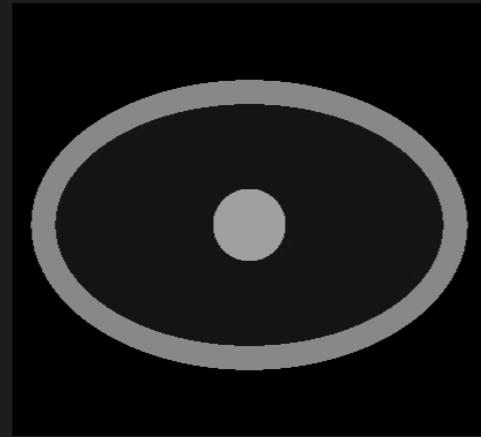
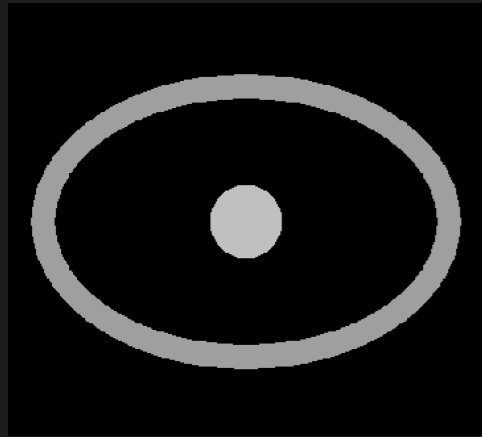

**No artefact**

**Ghosting**

**Worse artefact**

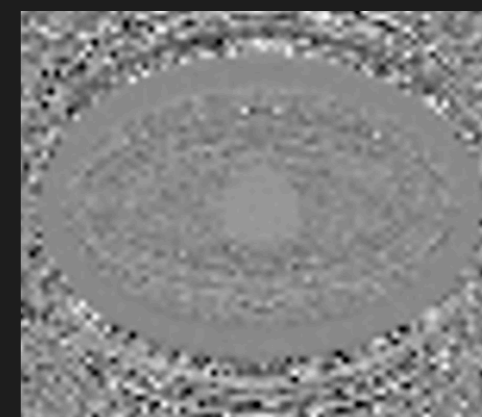
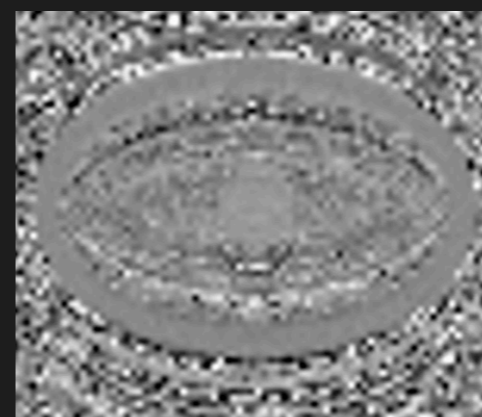
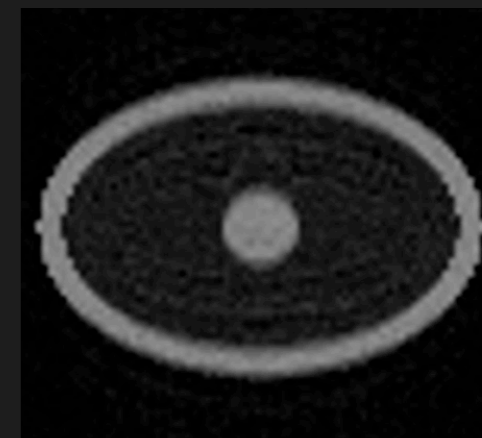
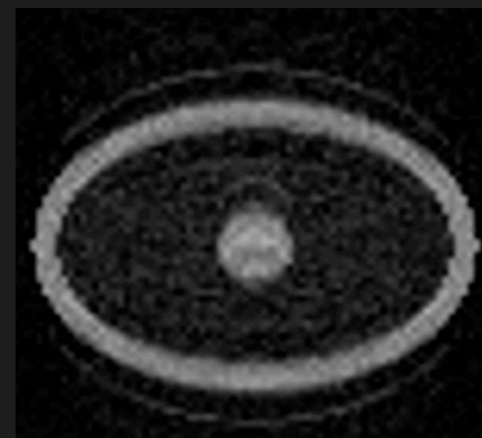
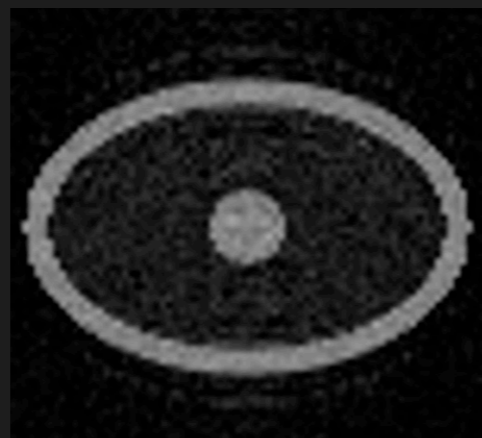
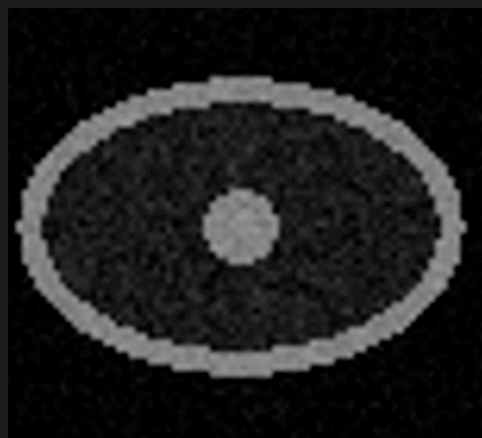
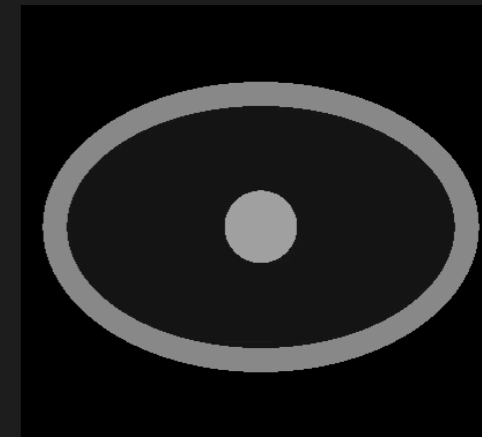
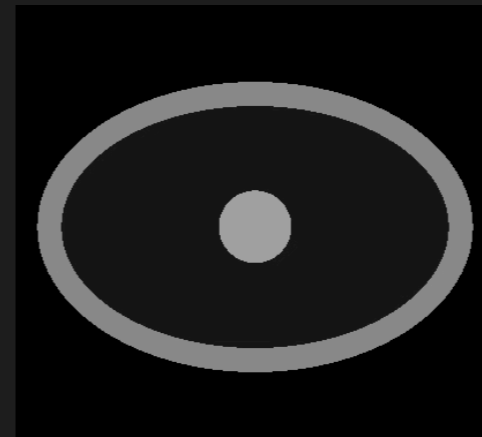
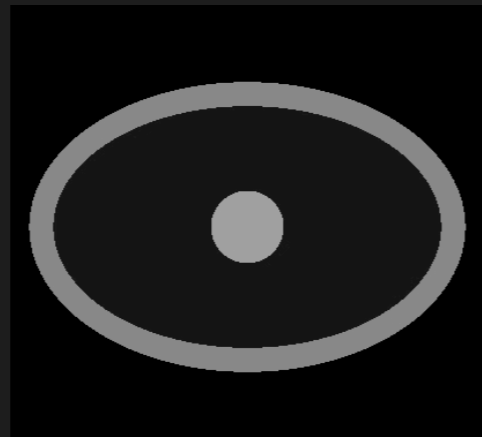
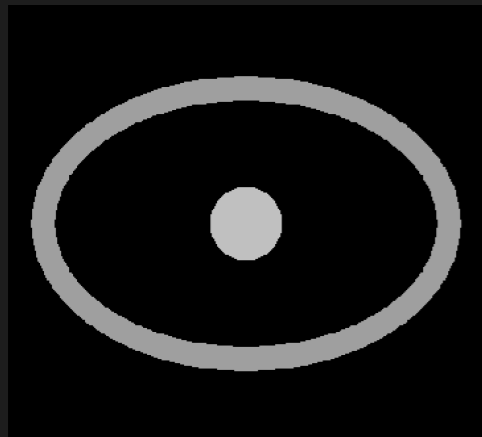

**No artefact**

**Ghosting**

**Worse artefact**

**Signal Average**



**Optimisation**



16 pixels

15 degree

Optimisation

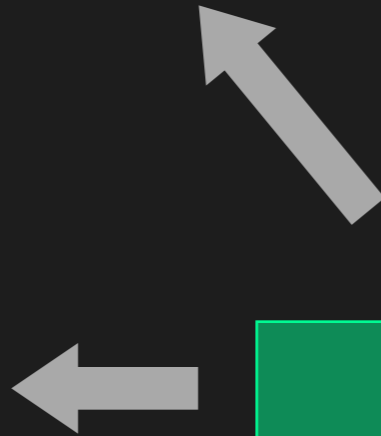

16 pixels

30 frames

15 degree

Optimisation

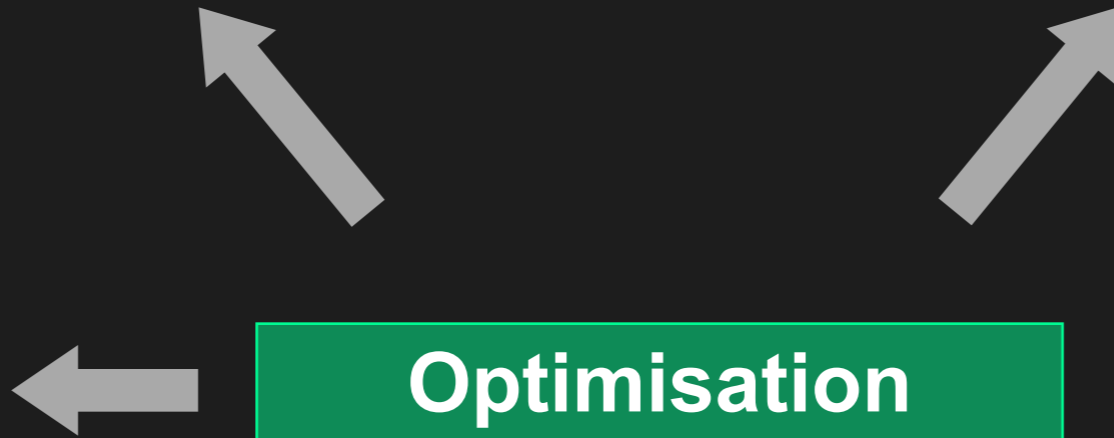

16 pixels

30 frames

15 degree

Optimisation

Free breathing

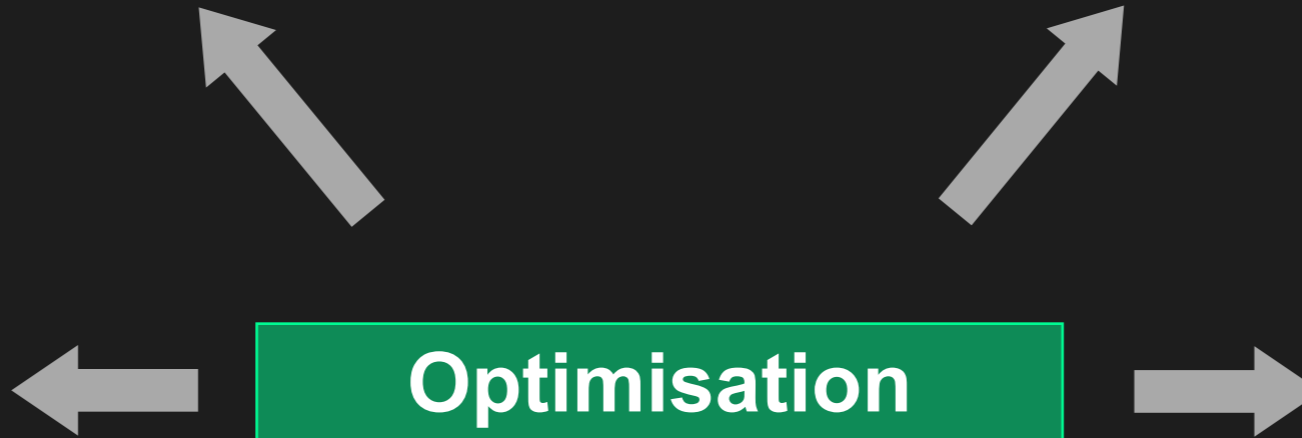



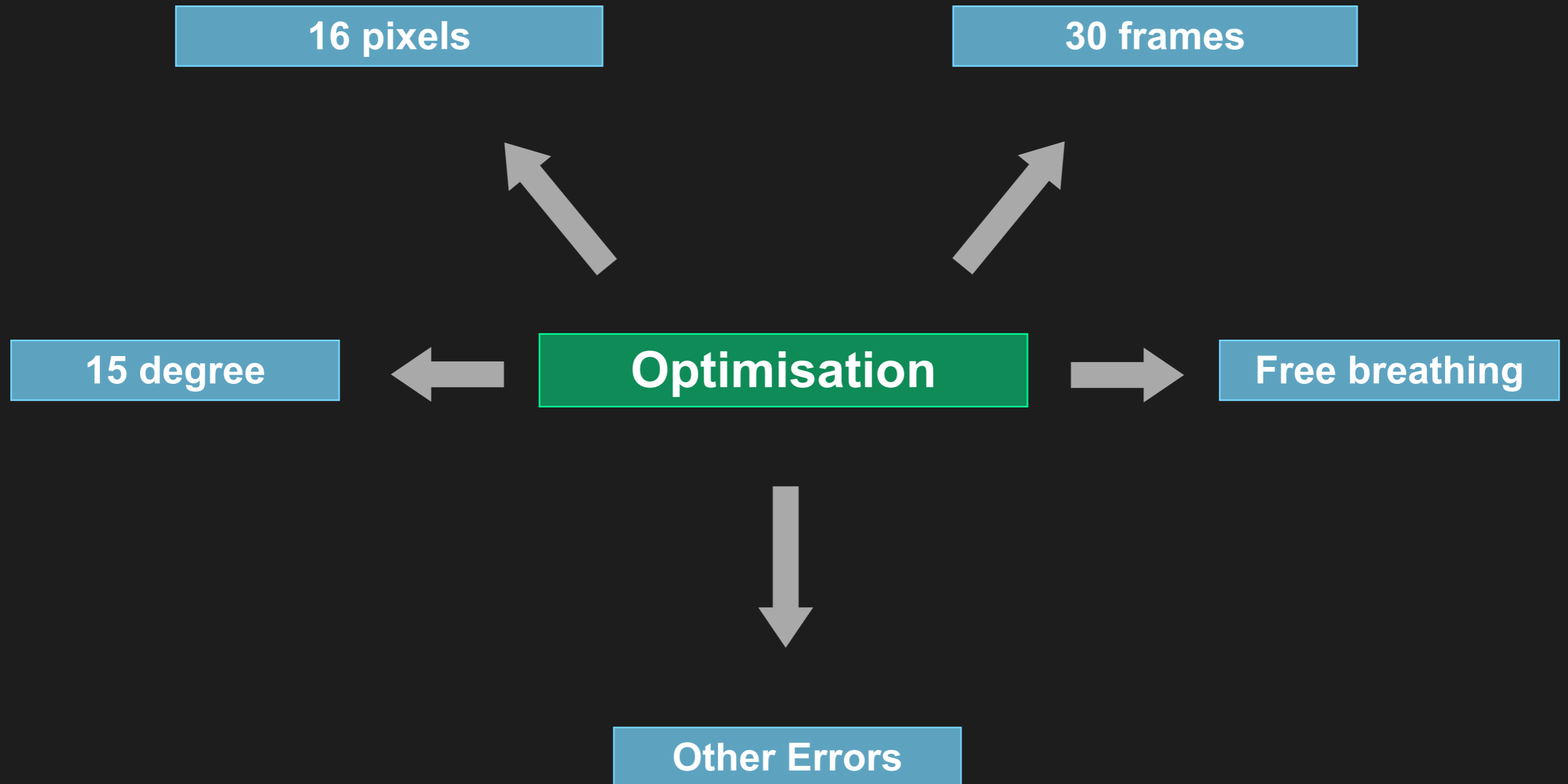

Gradients are not perfect

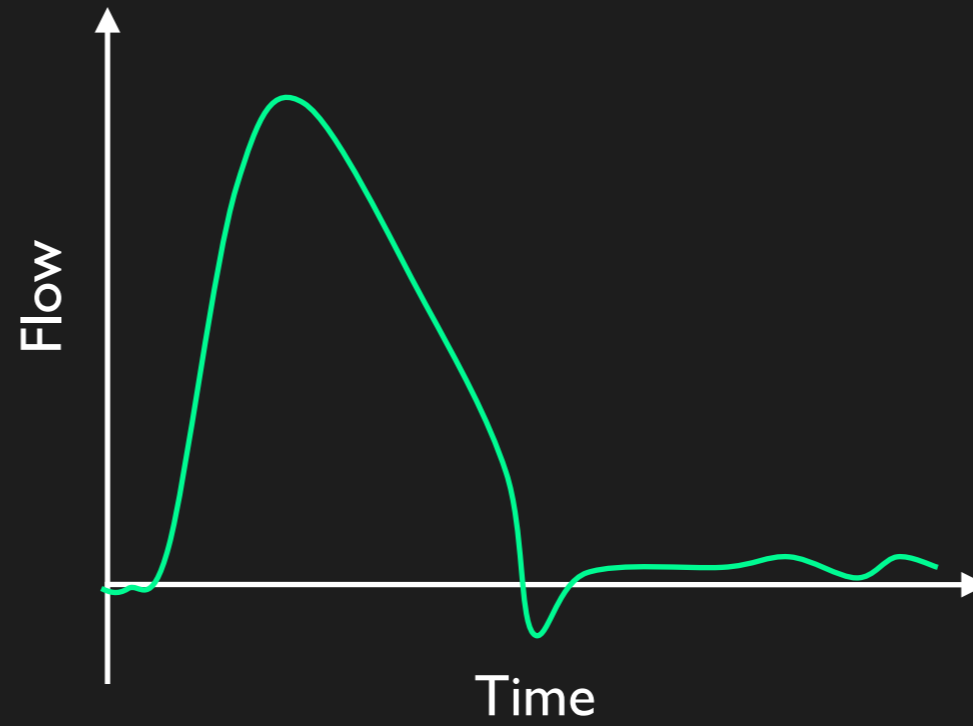

Gradients are not perfect

Maxwell terms

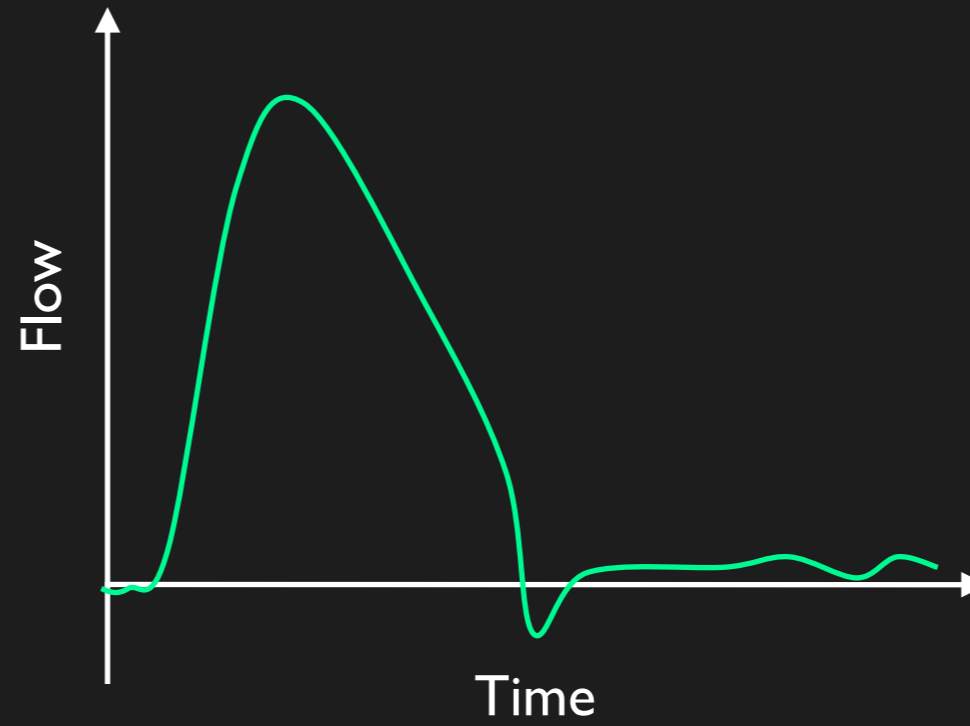

Gradients are not perfect

Maxwell terms

Eddy currents

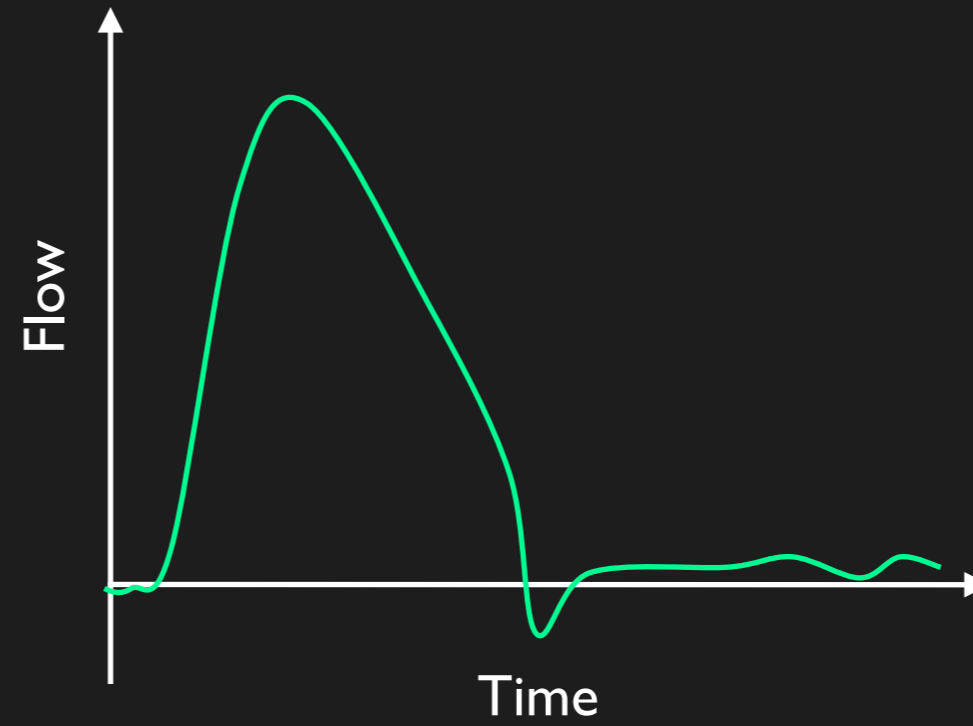

**Gradients are not perfect**

**Maxwell terms**

**Eddy currents**

**Encoding errors**

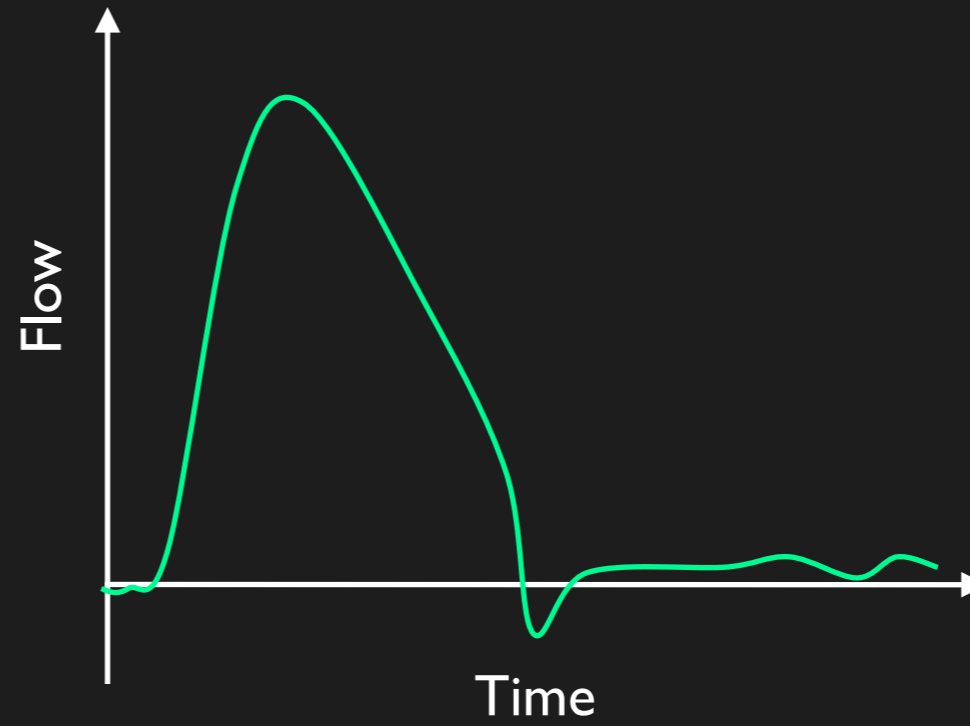

Gradients are not perfect

Maxwell terms

Eddy currents

Encoding errors

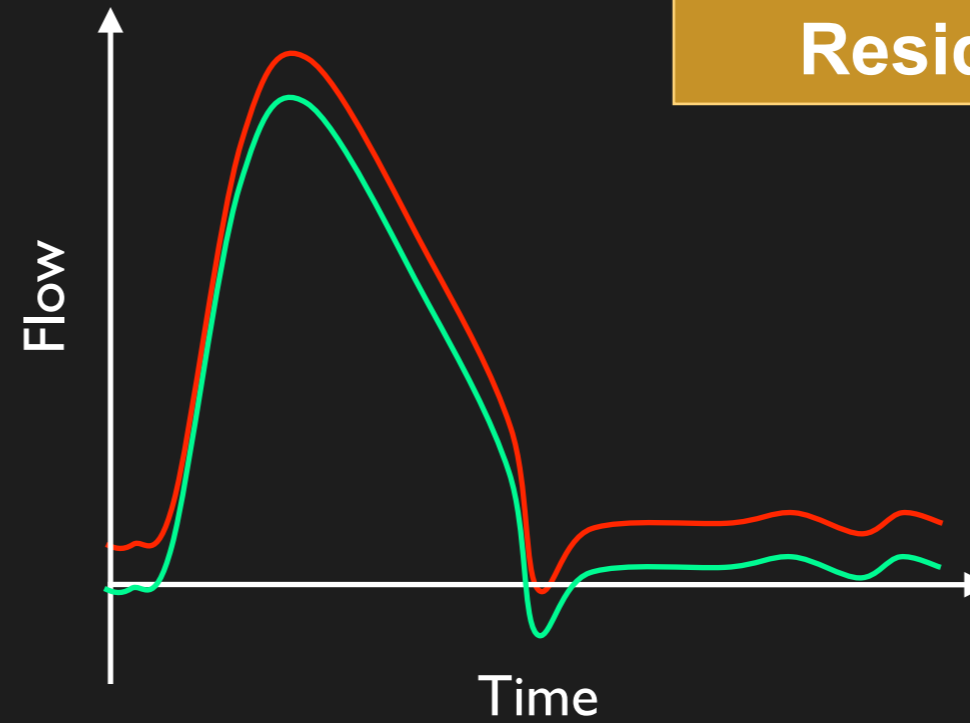

Residual offsets

Gradients are not perfect

Maxwell terms

Eddy currents

Encoding errors

Residual offsets

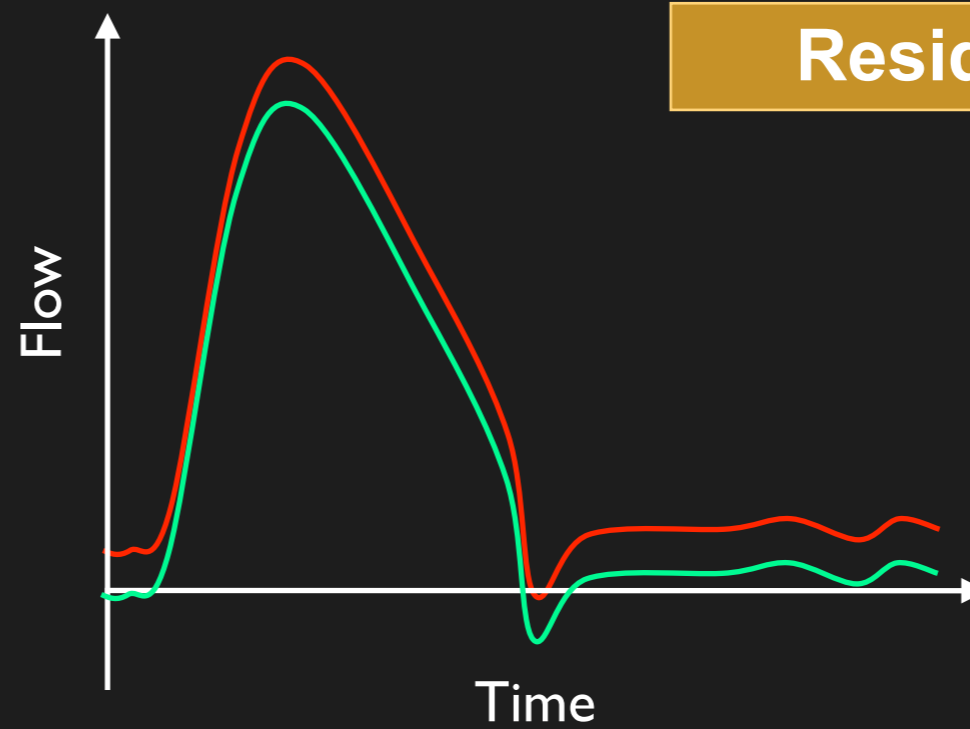

Phantom

Gradients are not perfect

Maxwell terms

Eddy currents

Encoding errors

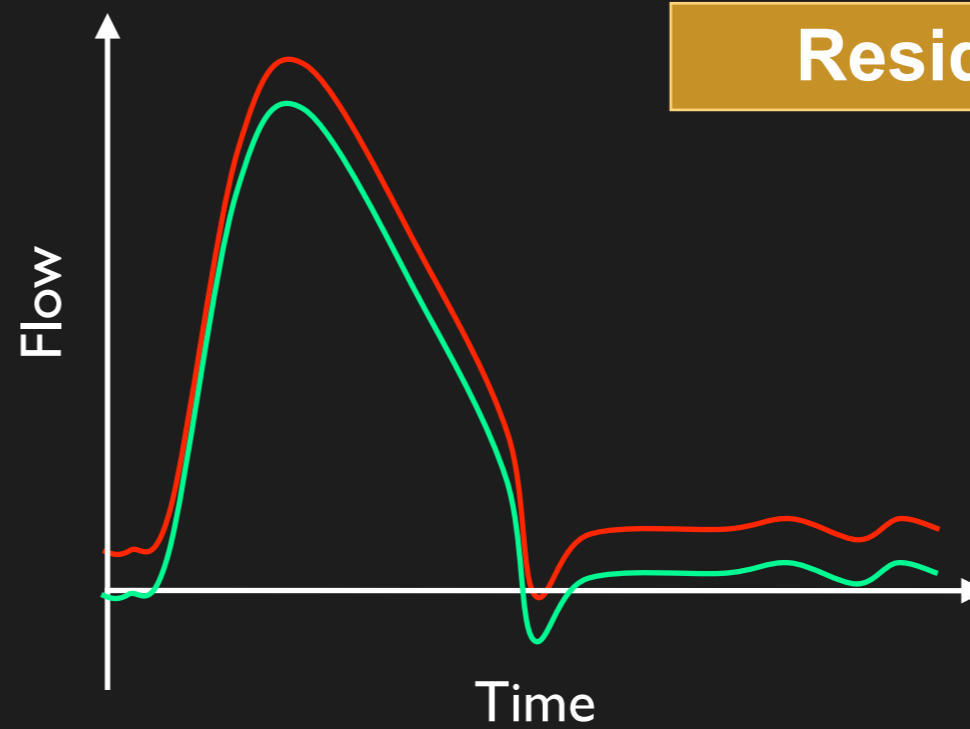

Residual offsets

Phantom

Software



Gradients are not perfect

Maxwell terms

Eddy currents

Encoding errors

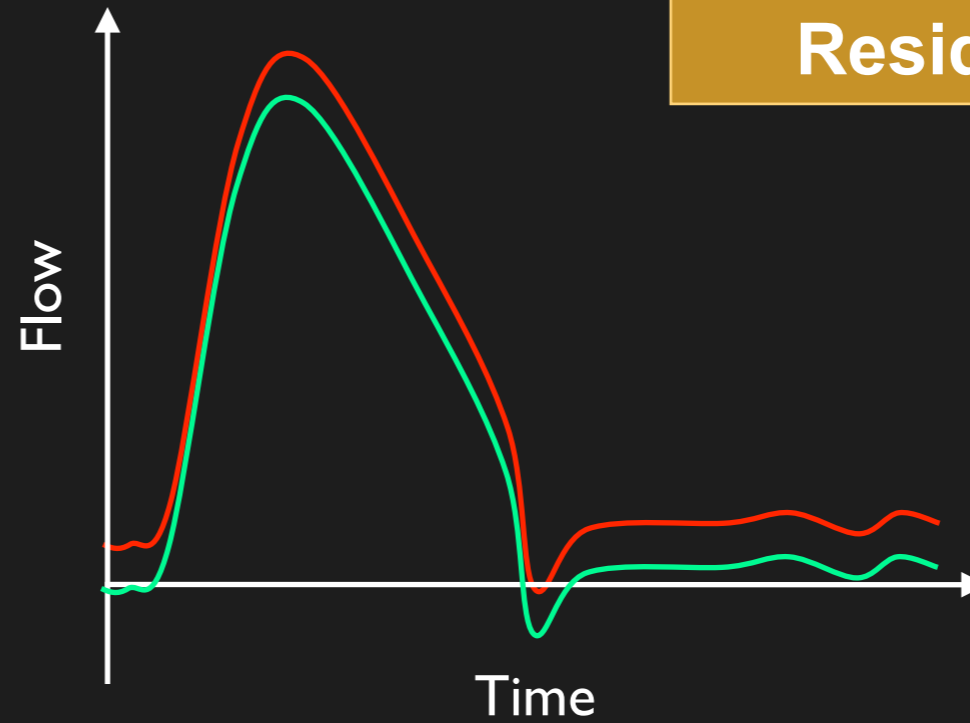

Residual offsets

Phantom

Software

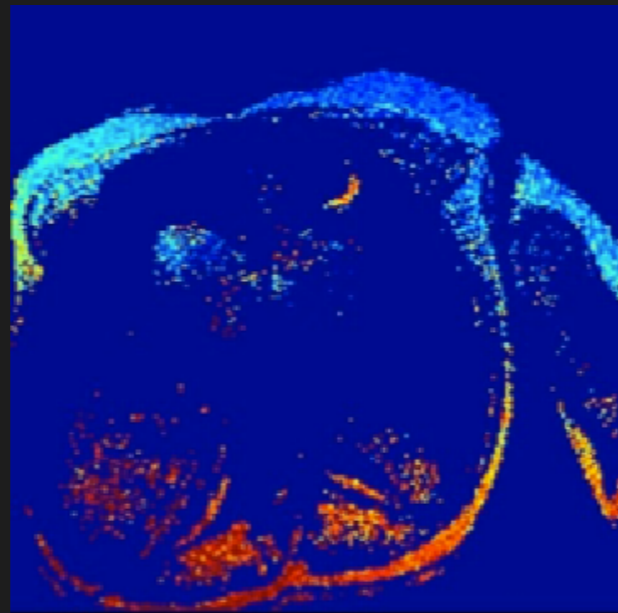

Gradients are not perfect

Maxwell terms

Eddy currents

Encoding errors

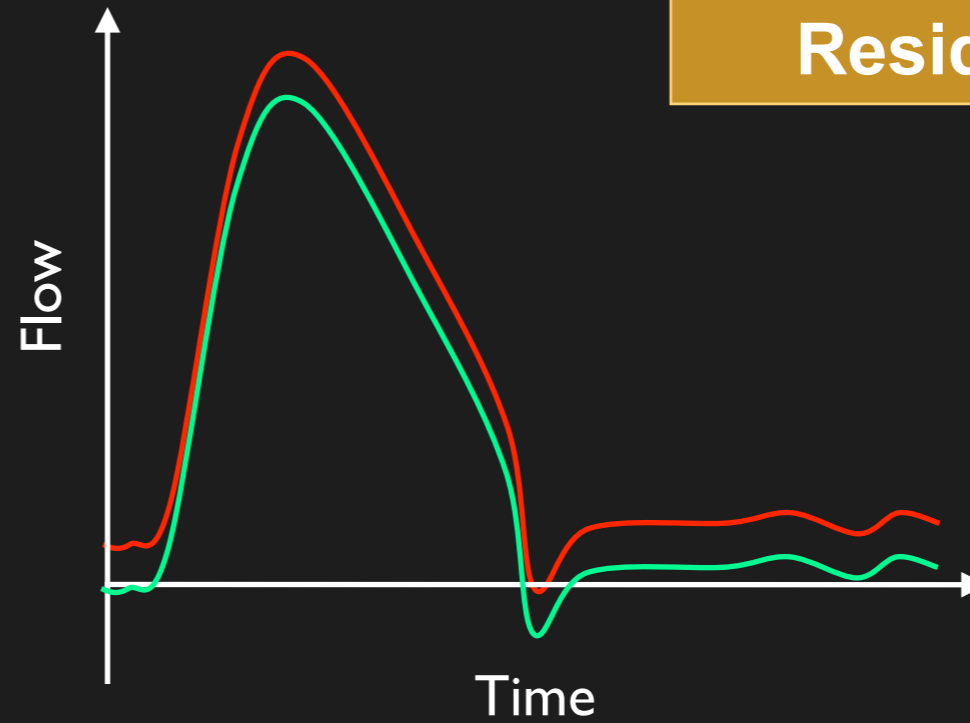

Residual offsets

Phantom

Software

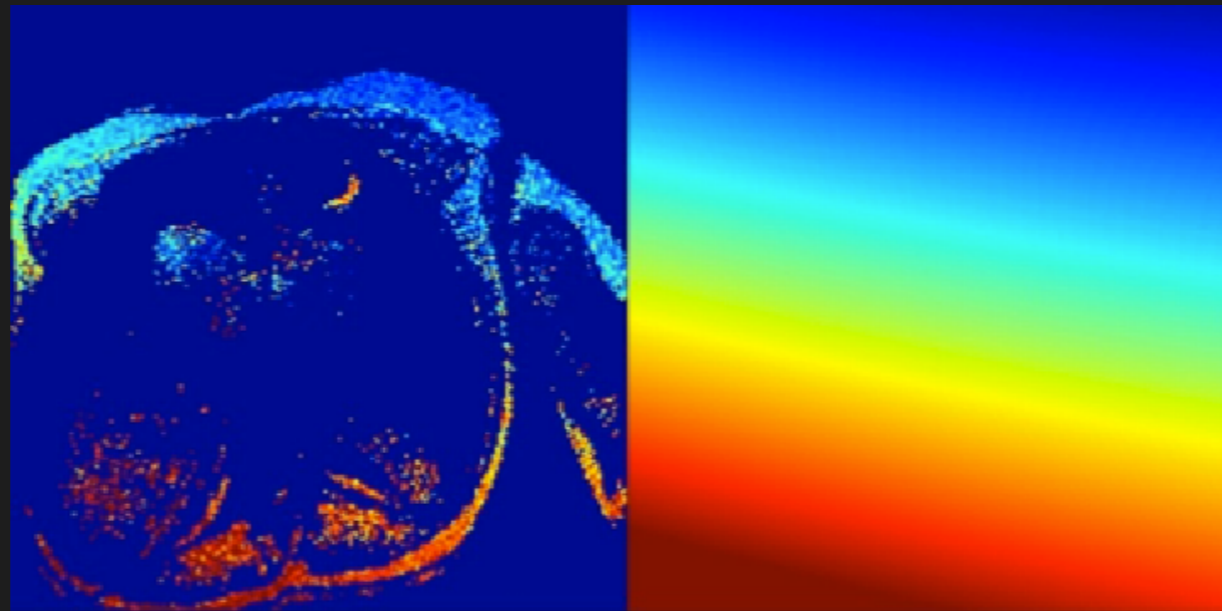

Gradients are not perfect

Maxwell terms

Eddy currents

Encoding errors

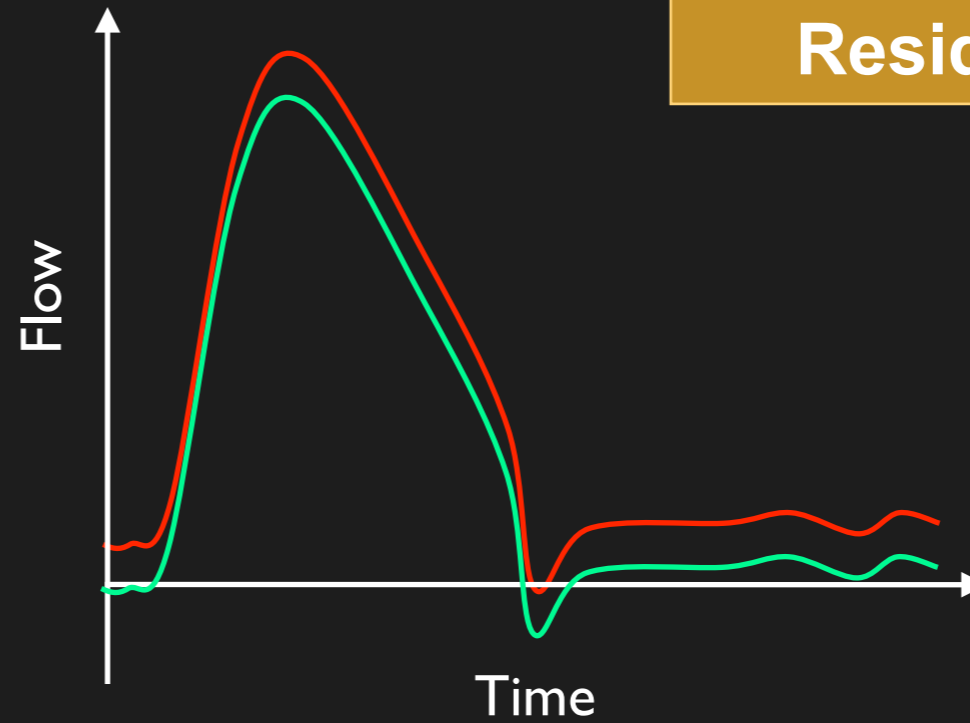

Residual offsets

Phantom

Software

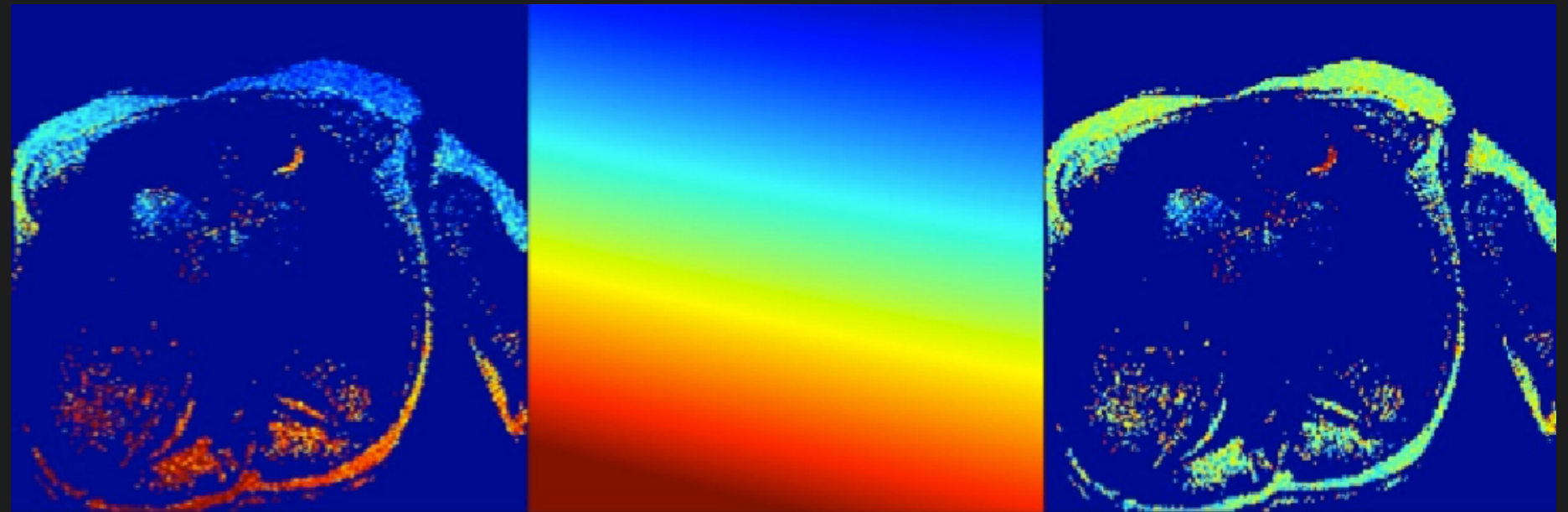

# Peak Velocity

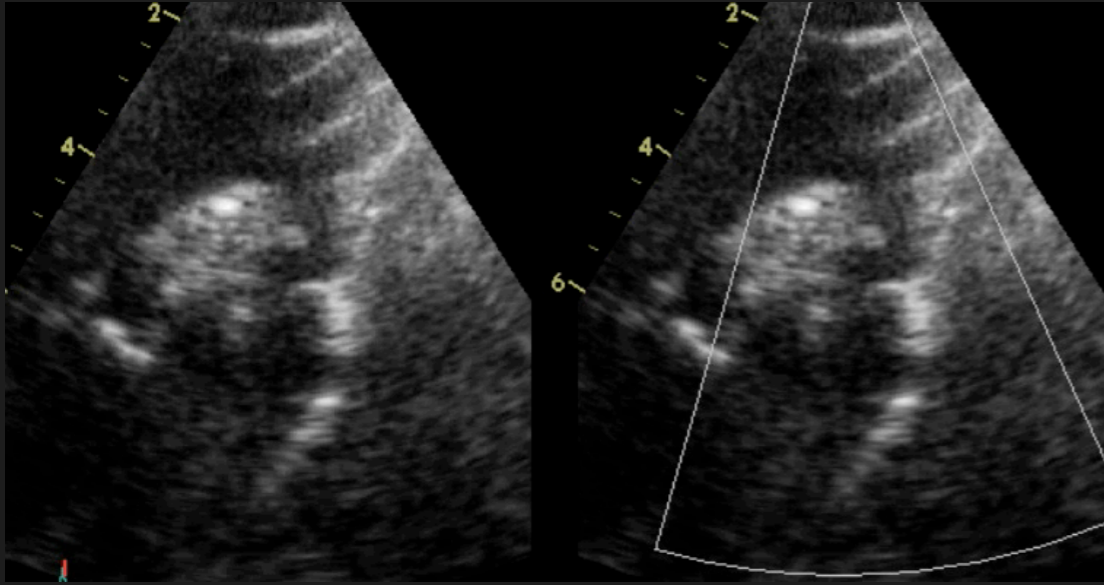

# Peak Velocity

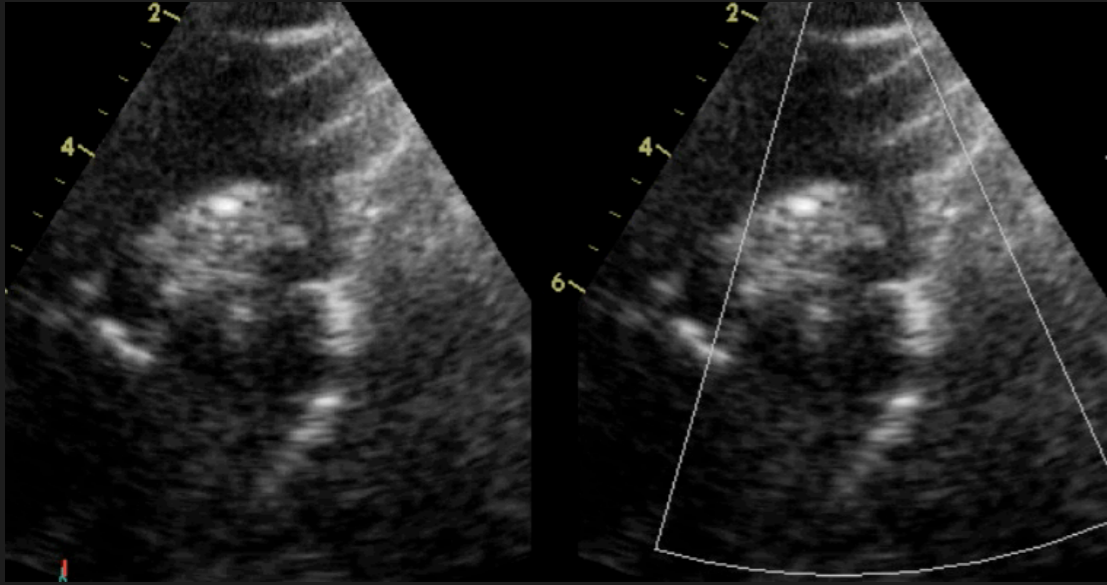

# Peak Velocity

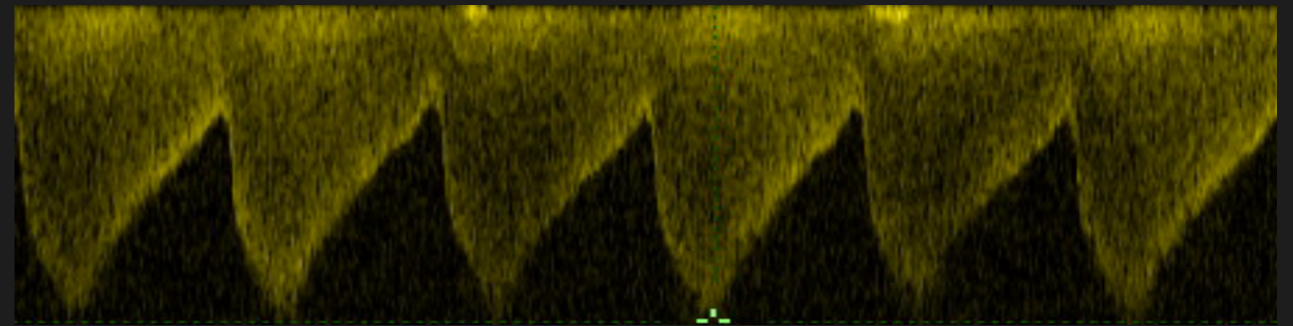
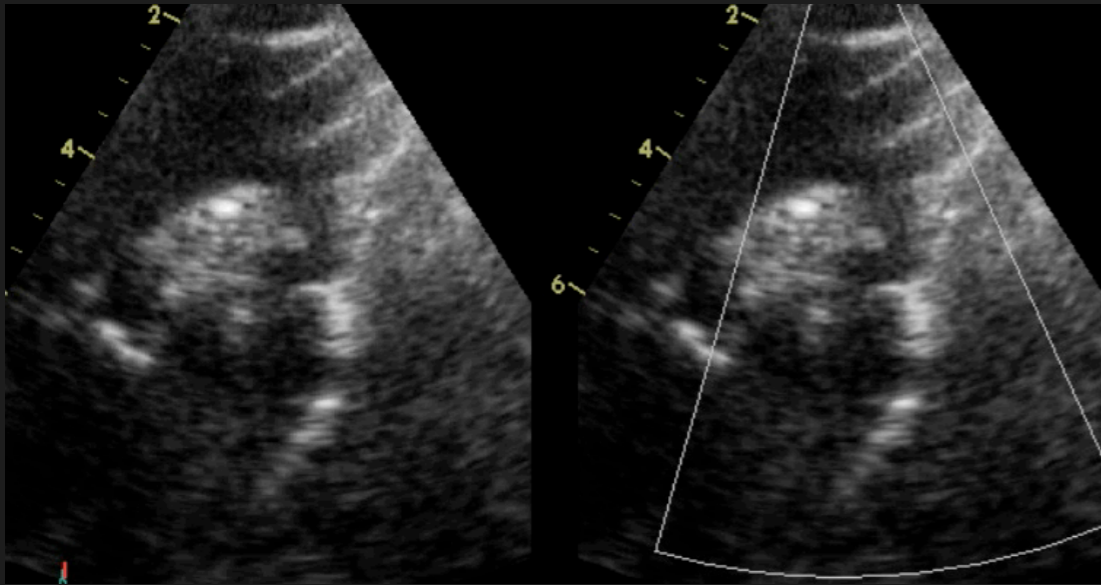

**Doppler Reference**

# Peak Velocity

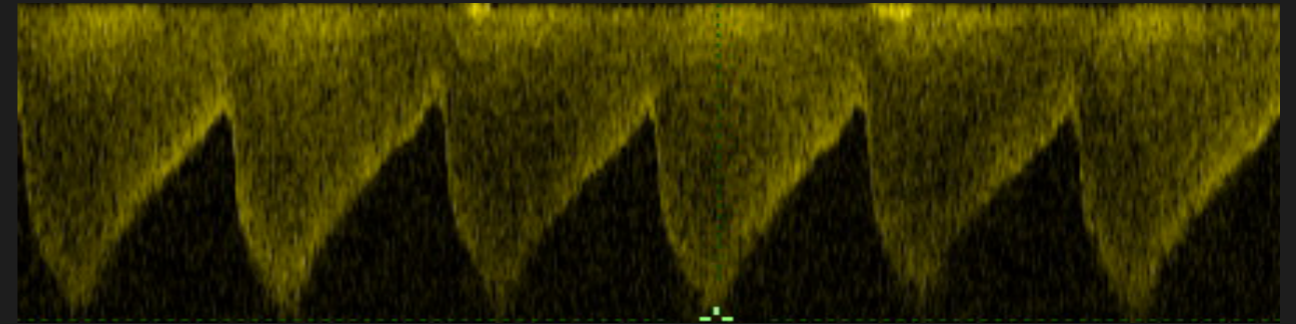
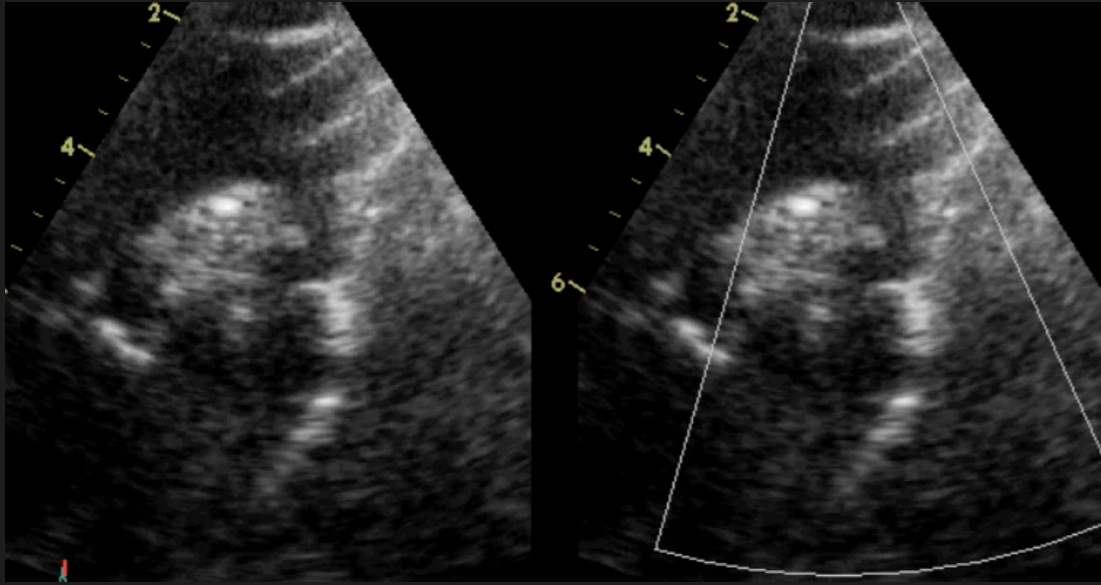

**Doppler Reference**

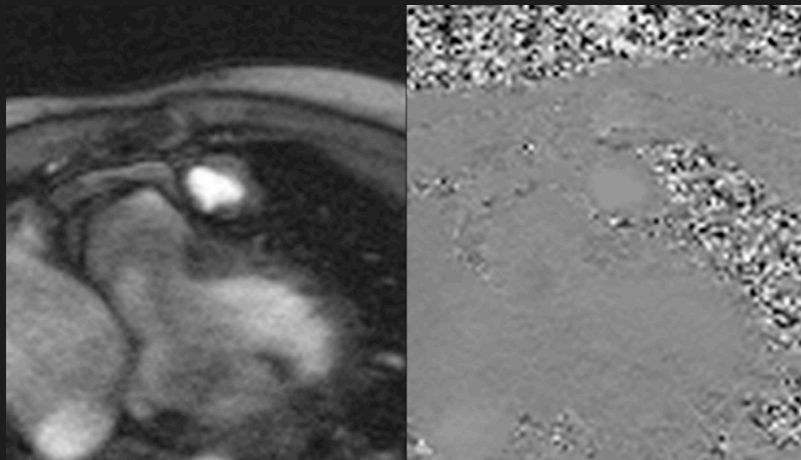

# Peak Velocity

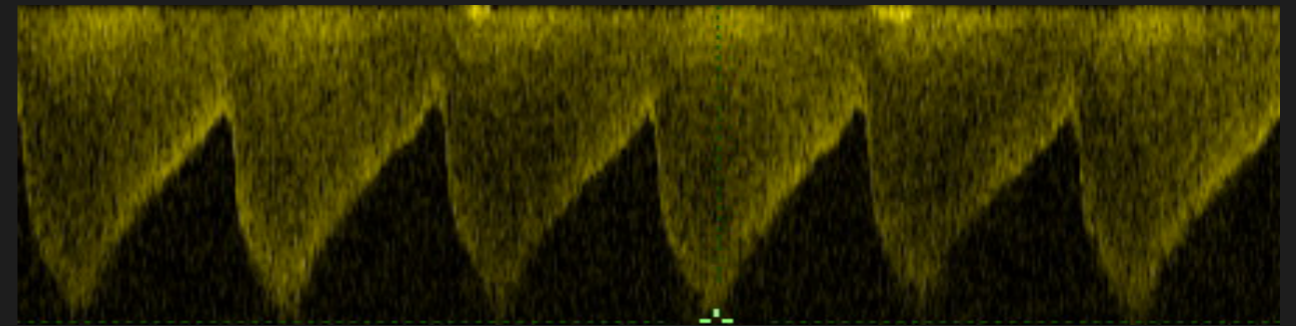
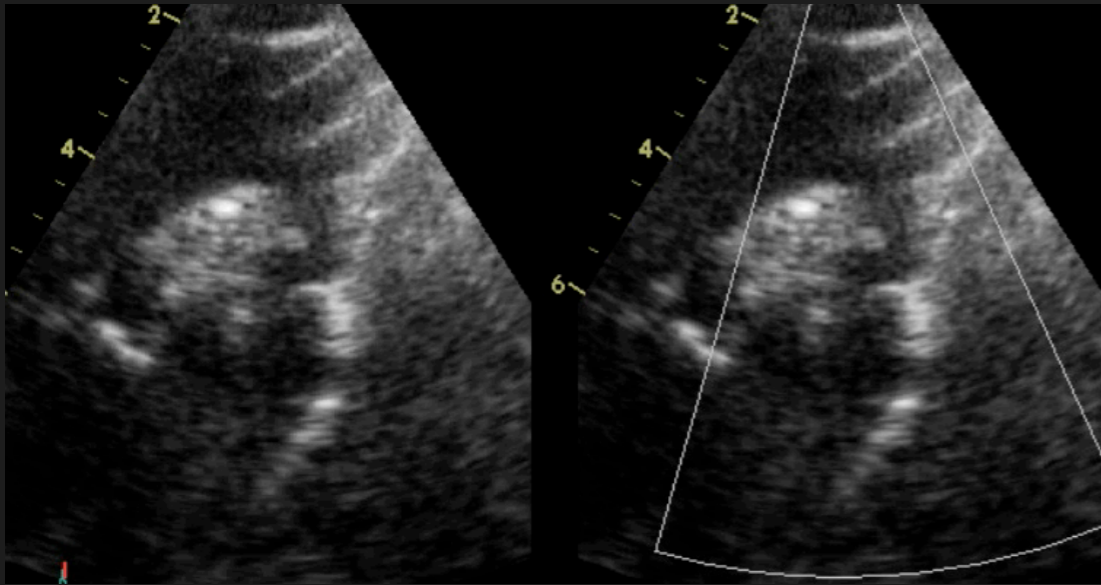

Doppler Reference

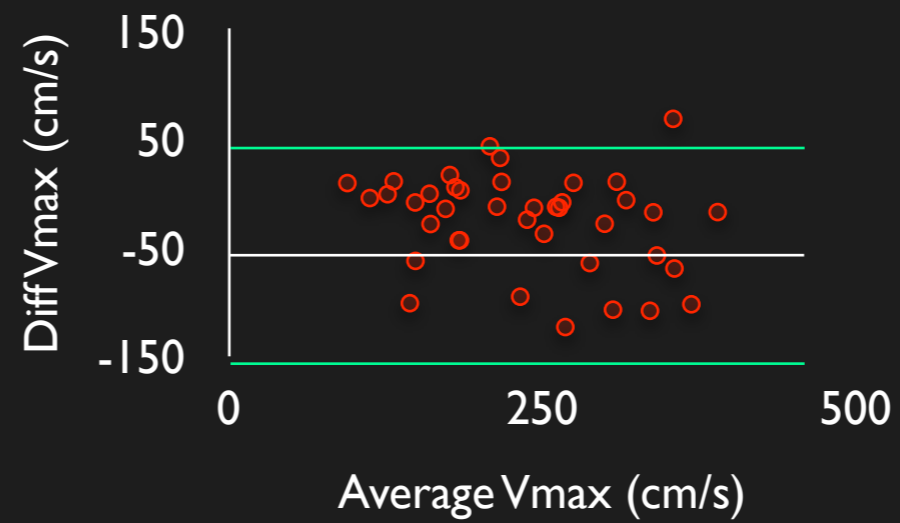
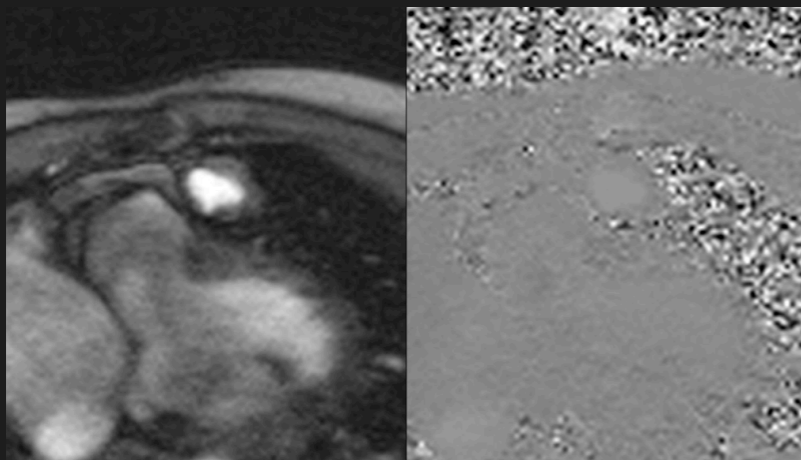

Bias 0.4m/s



# Peak Velocity

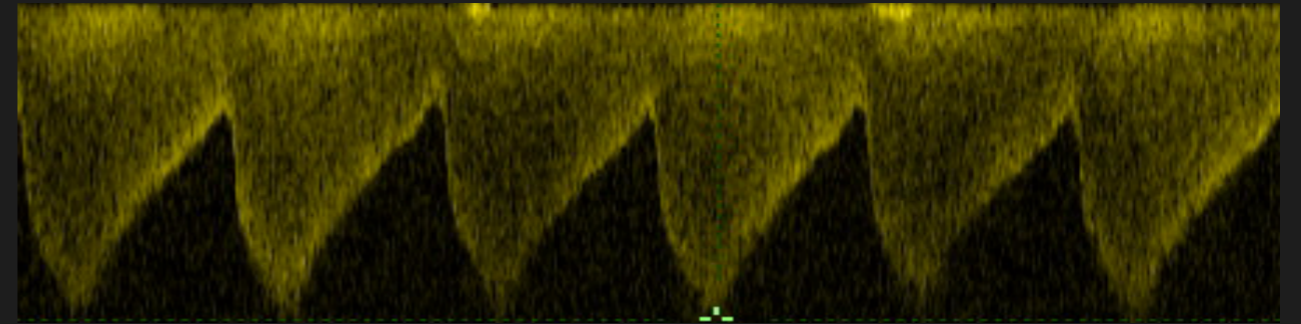
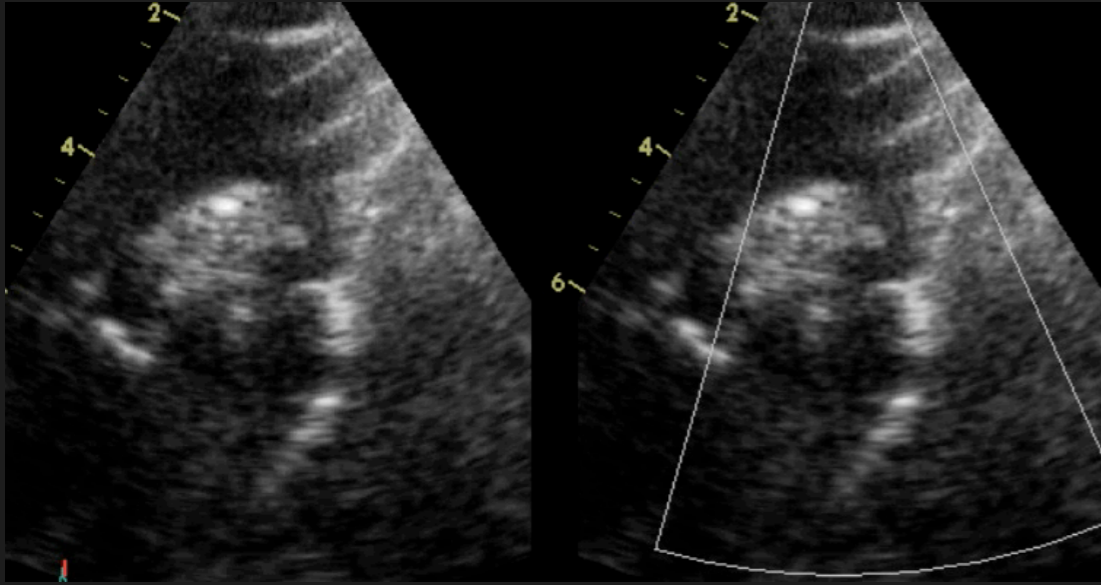

**Doppler Reference**

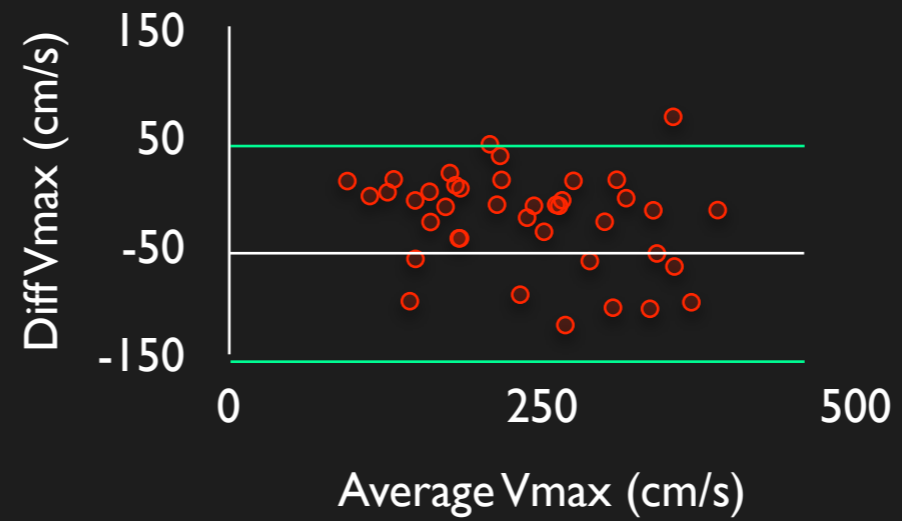
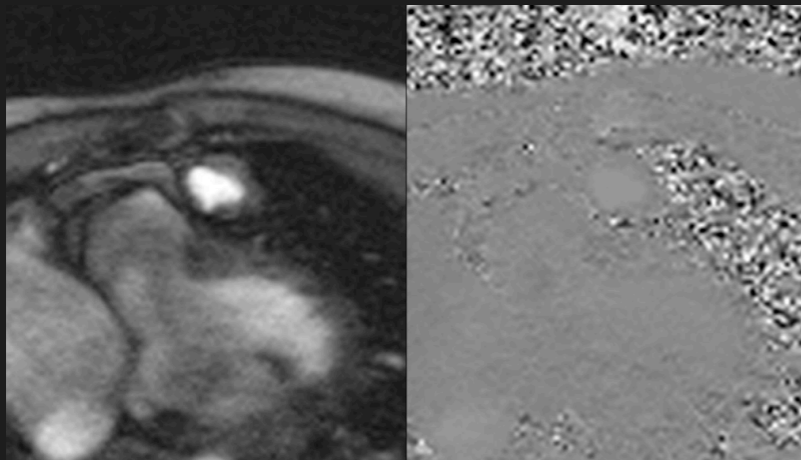

**Bias 0.4m/s**

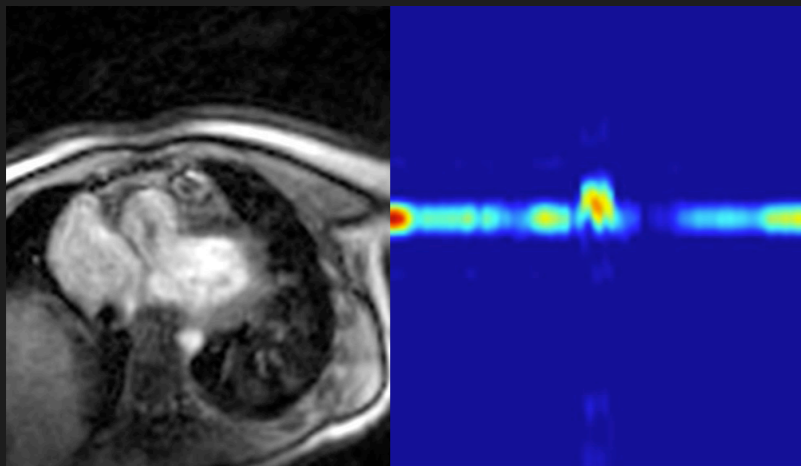

# Peak Velocity

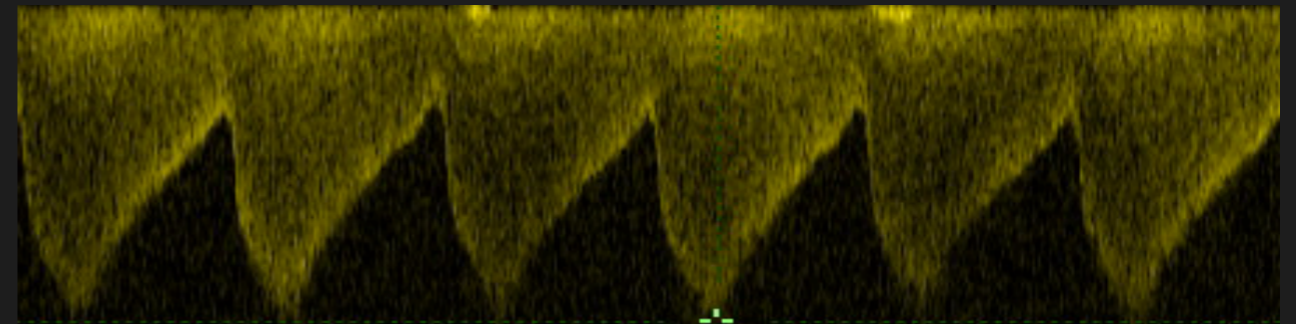
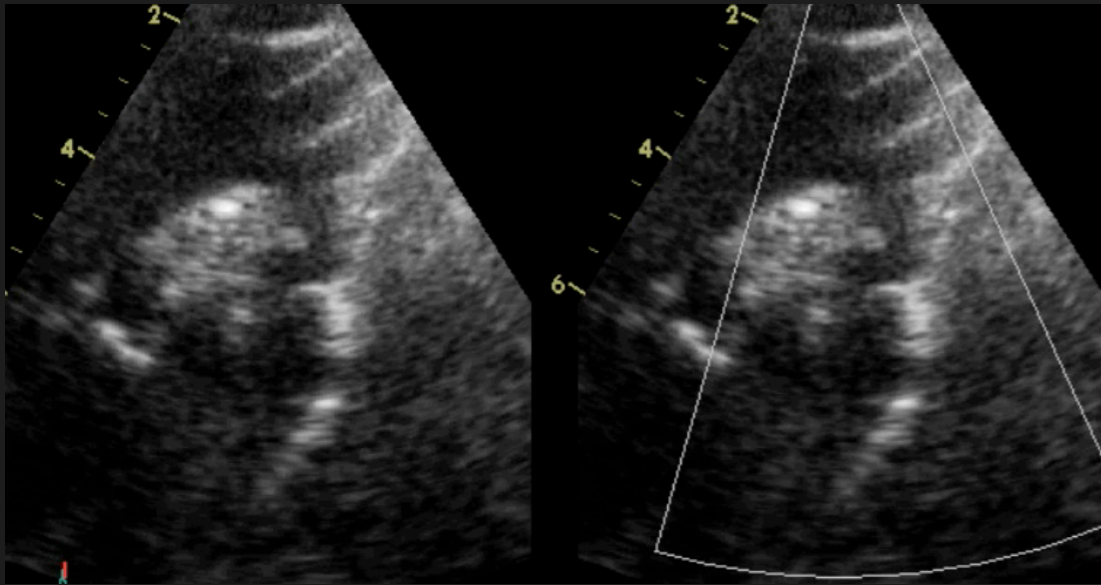

**Doppler Reference**

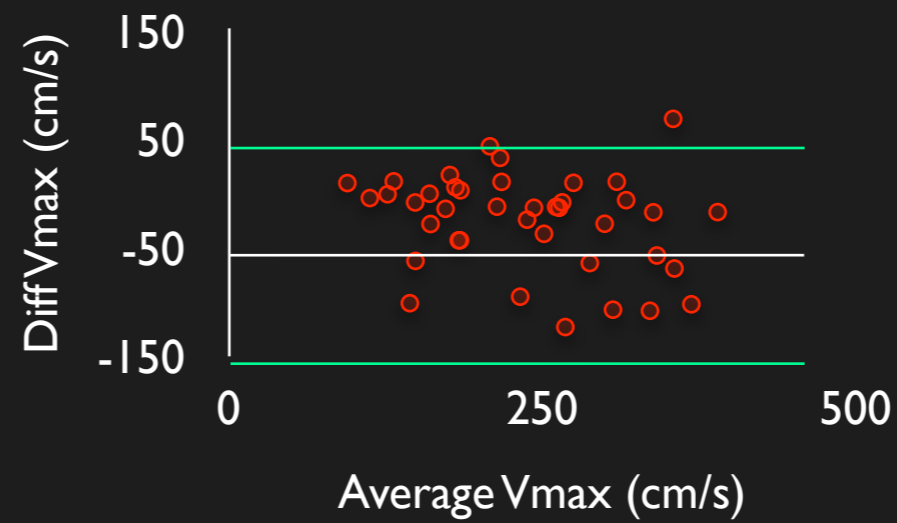
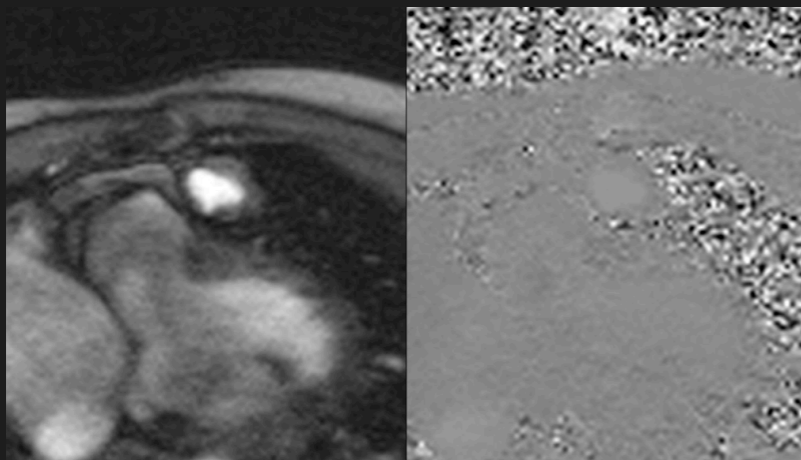

**Bias 0.4m/s**

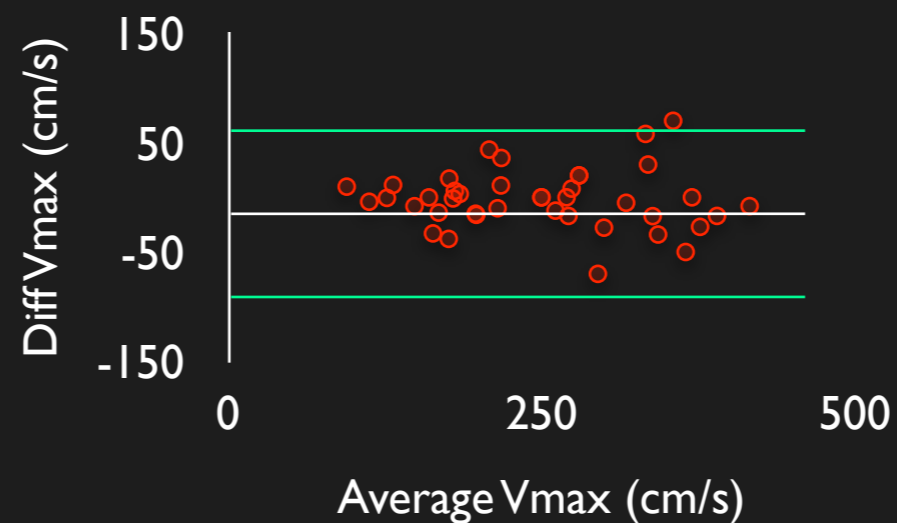
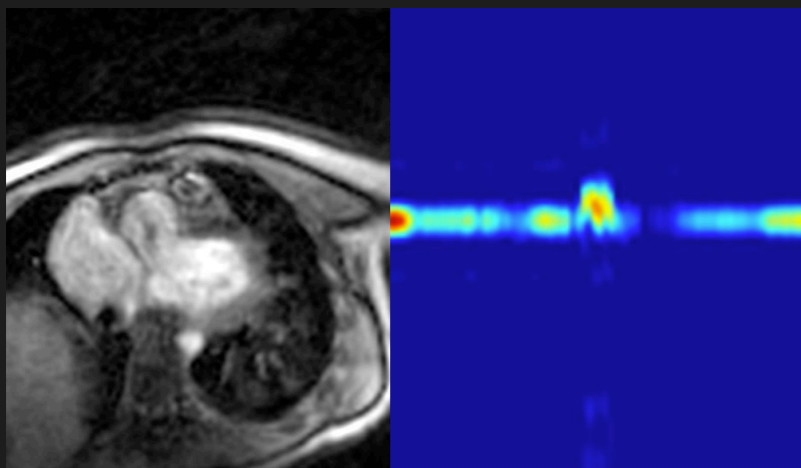

**No bias**

# Large vessels

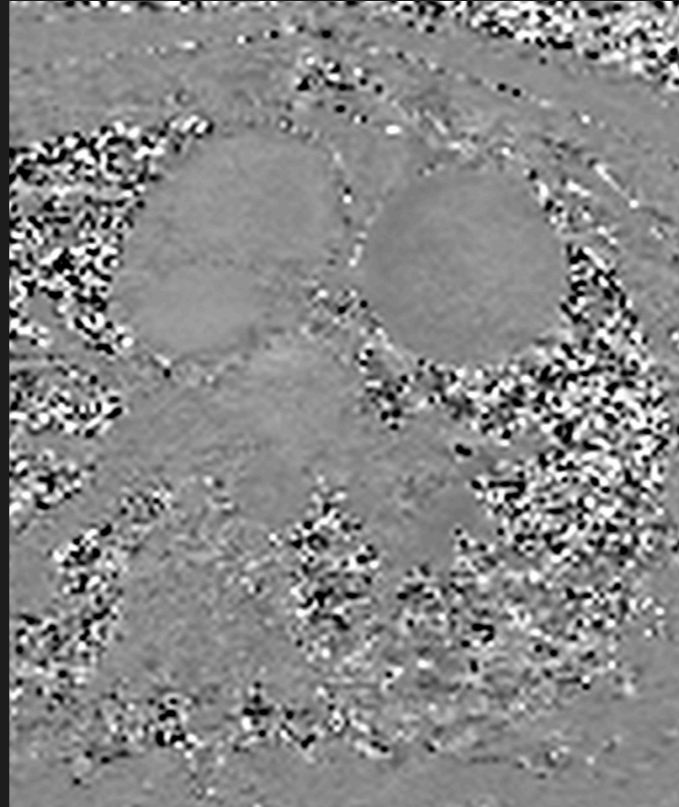
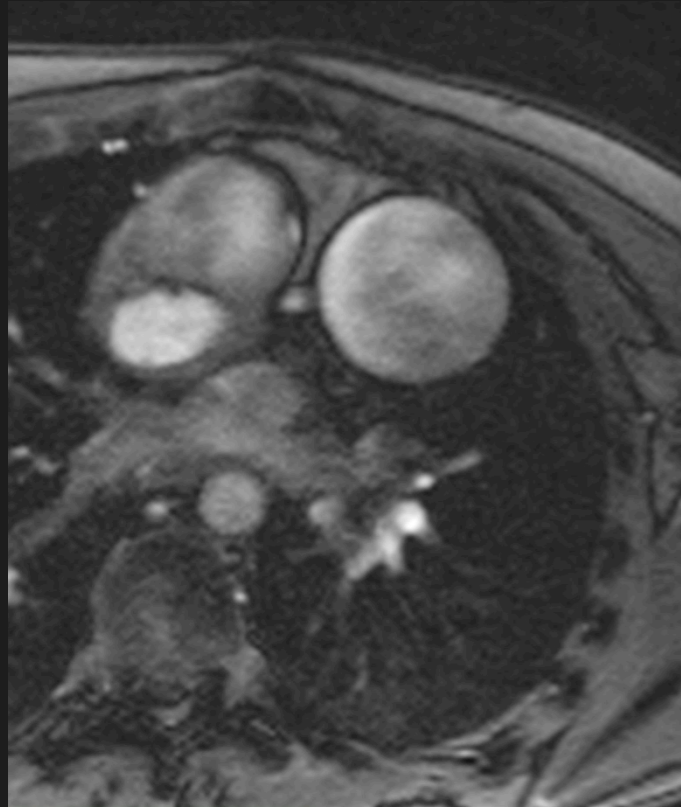

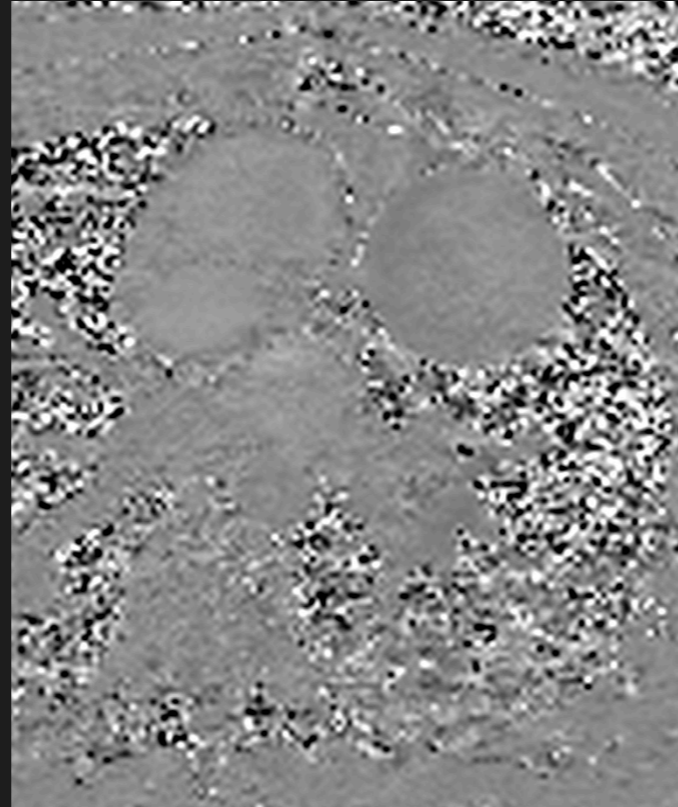
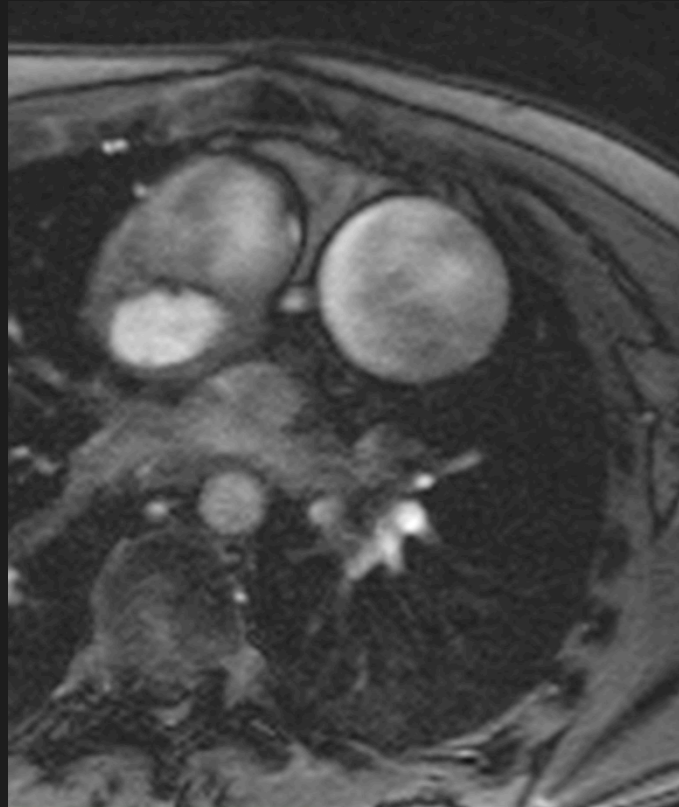

Large vessels

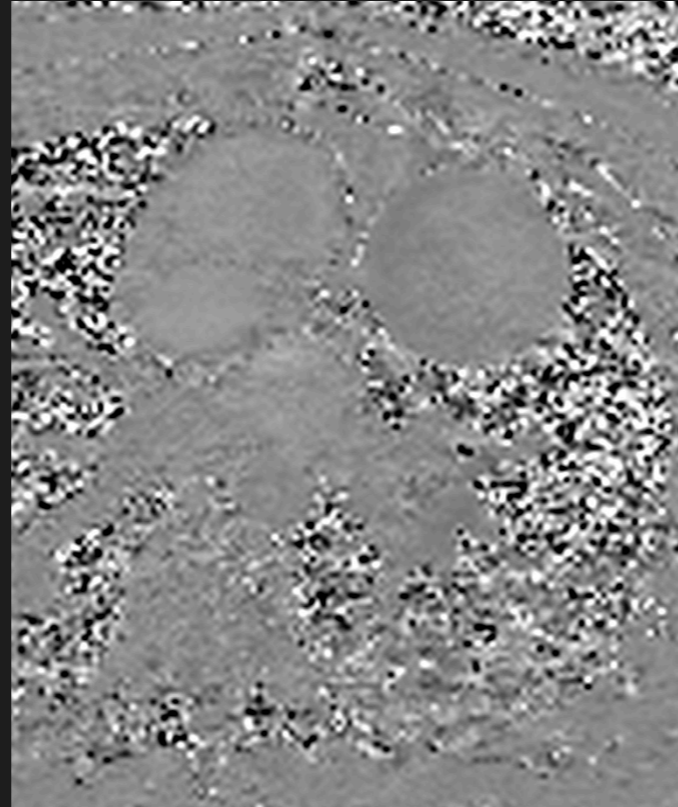
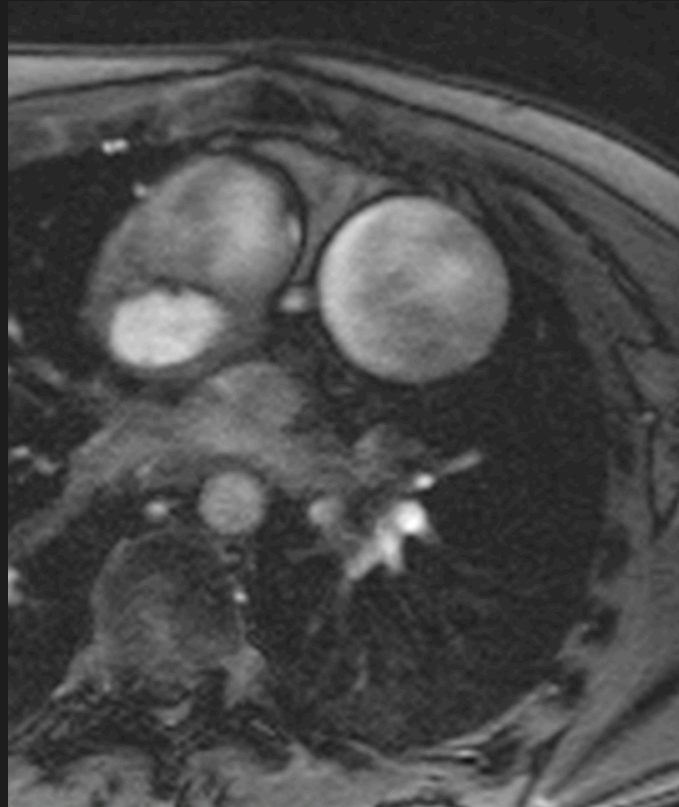

**Large vessels**

**Swirling flow**

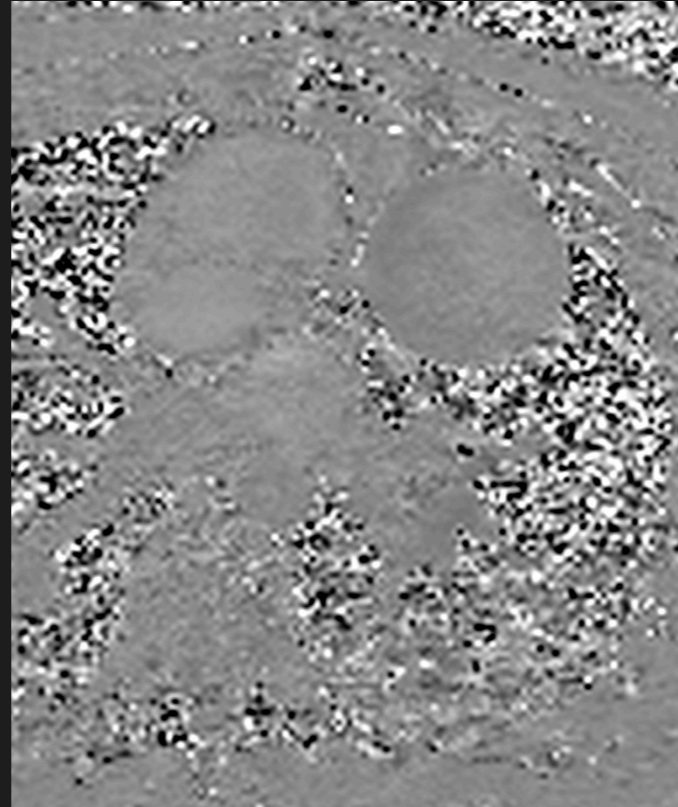
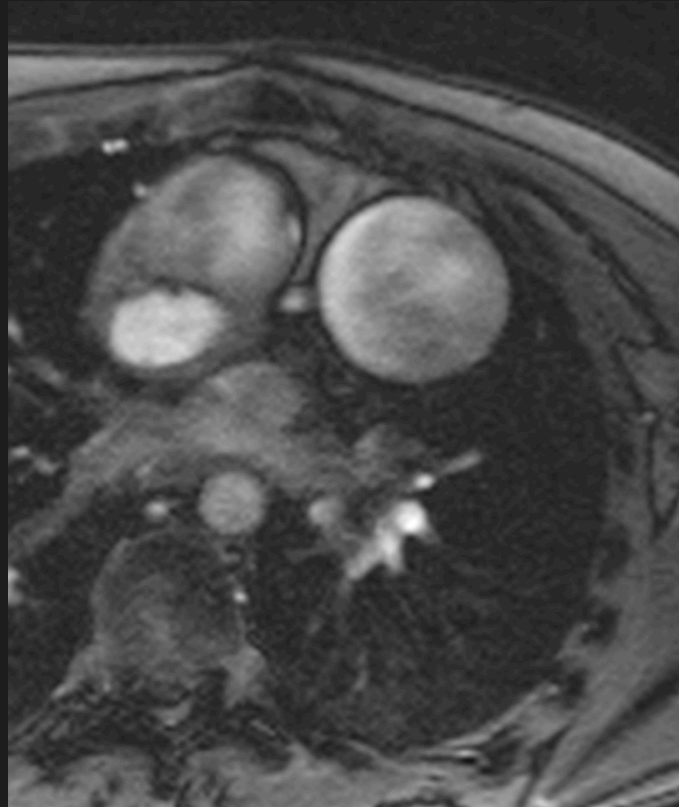

Large vessels

Swirling flow

Inaccurate Q estimation

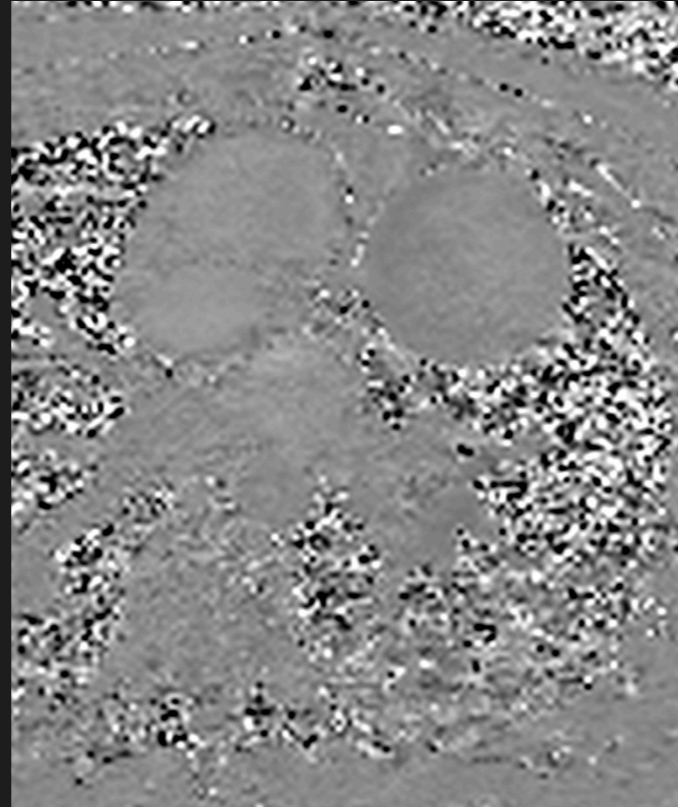
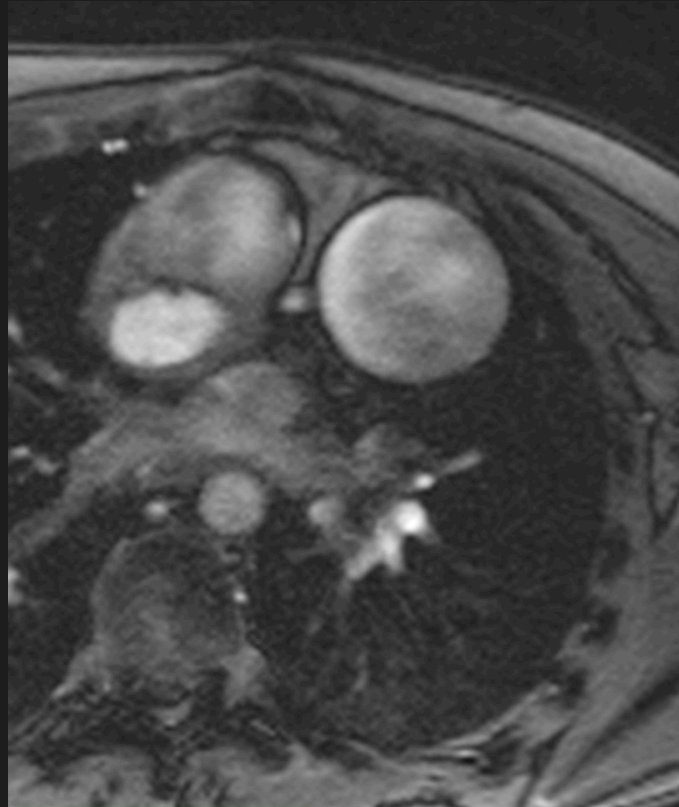

Large vessels

Swirling flow

Inaccurate Q estimation

Be creative!

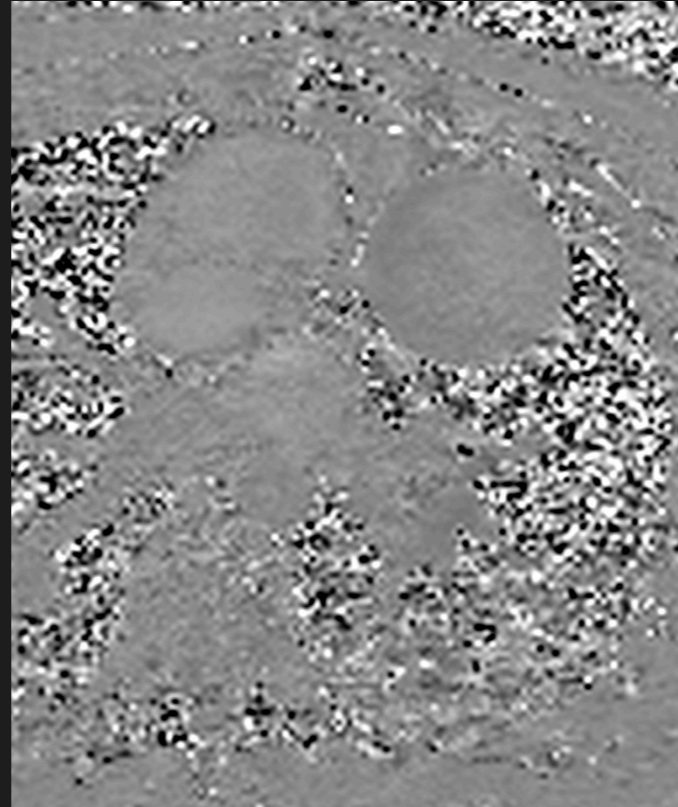
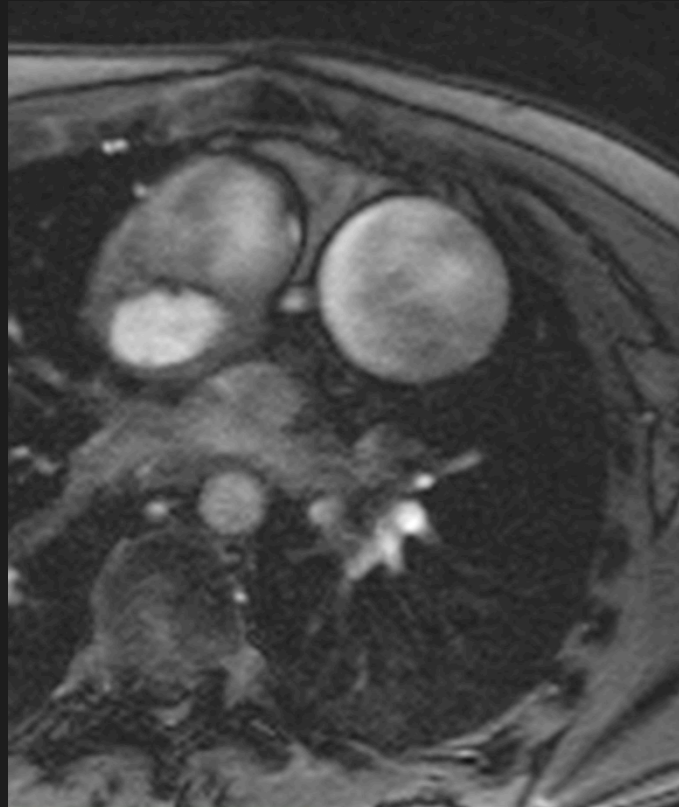

Large vessels

Swirling flow

Inaccurate Q estimation

Be creative!

Different ways to calculate QS



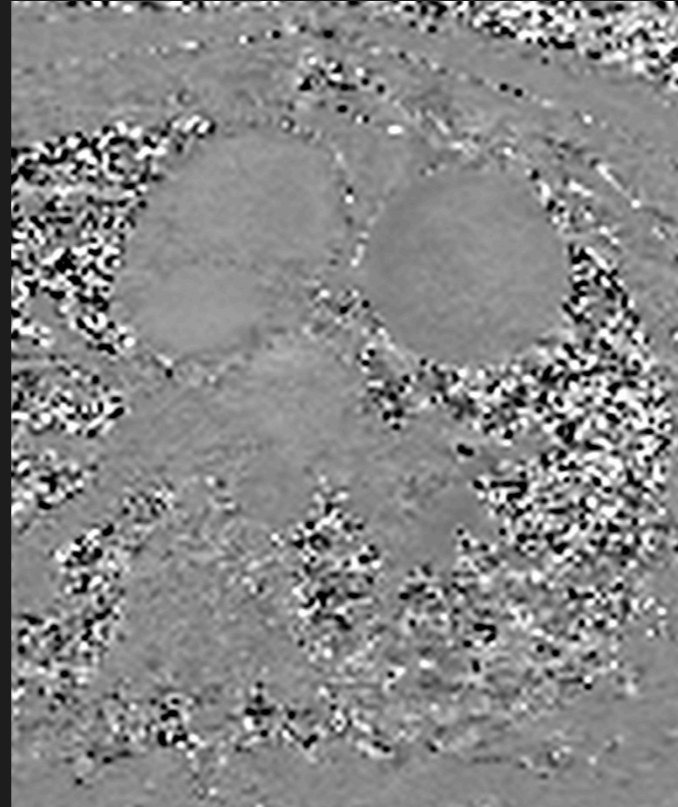
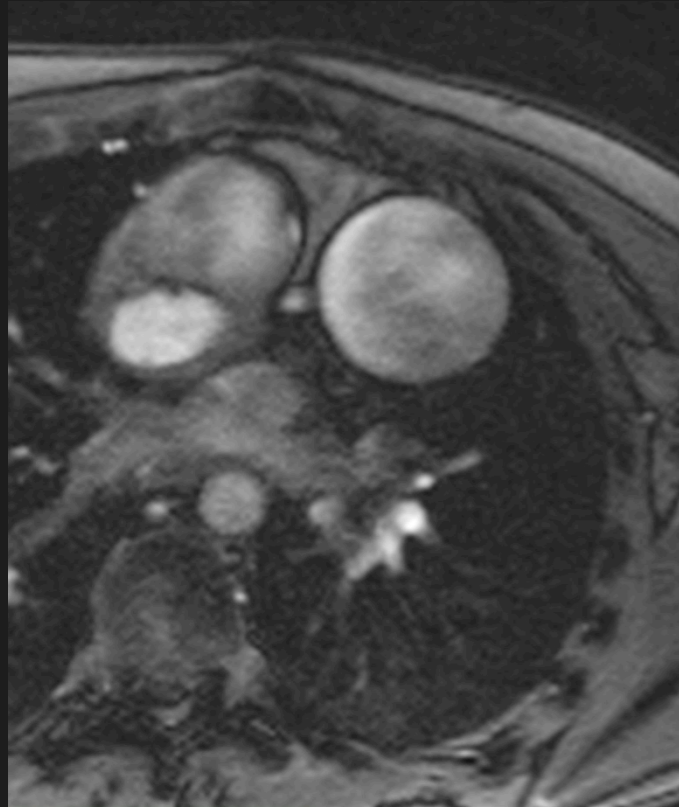

Large vessels

Swirling flow

Inaccurate Q estimation

Be creative!

Different ways to calculate QS

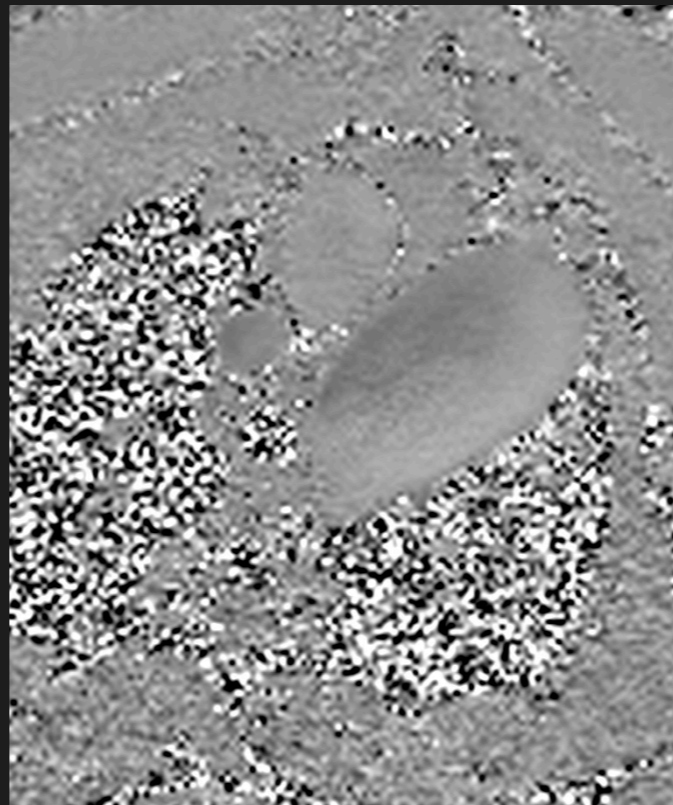

SVC

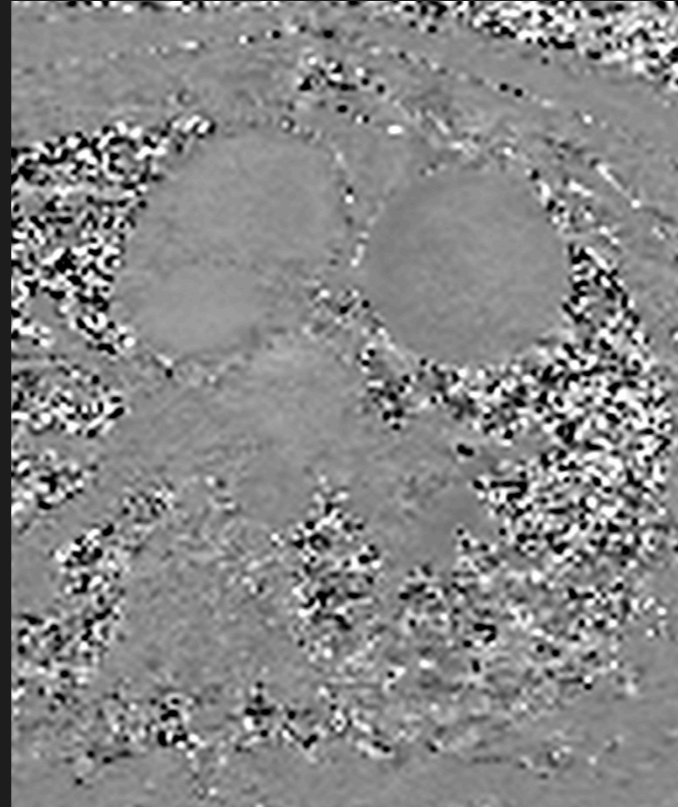
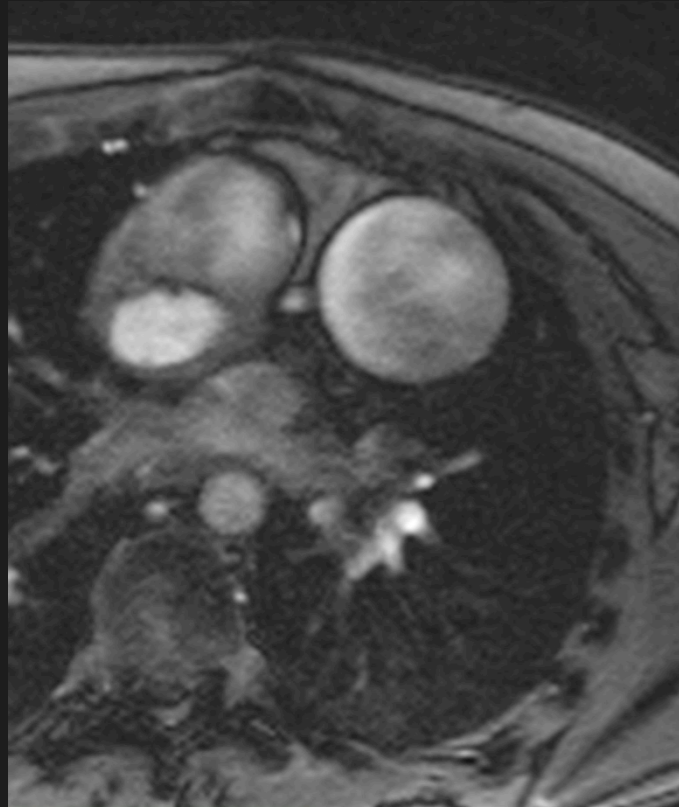

Large vessels

Swirling flow

Inaccurate Q estimation

Be creative!

Different ways to calculate QS

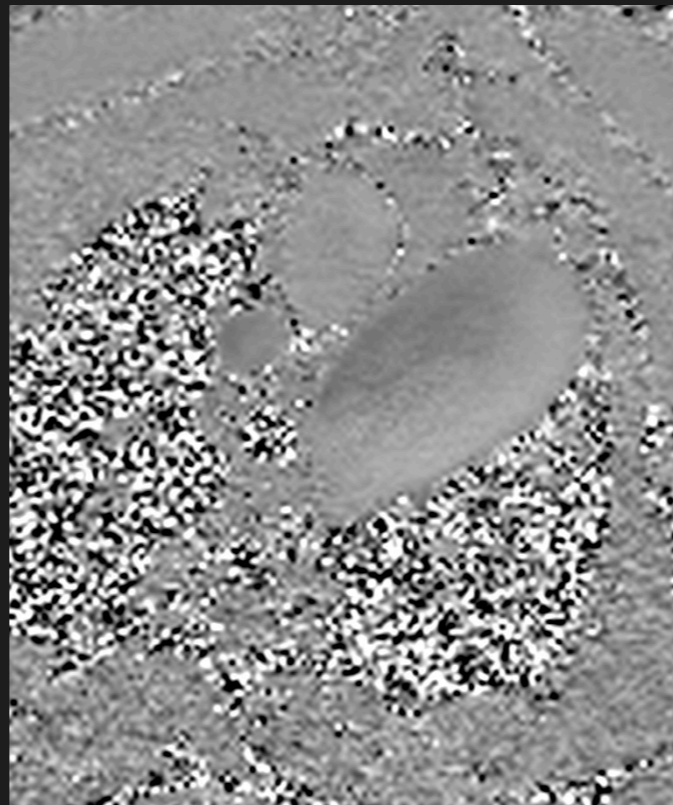

SVC

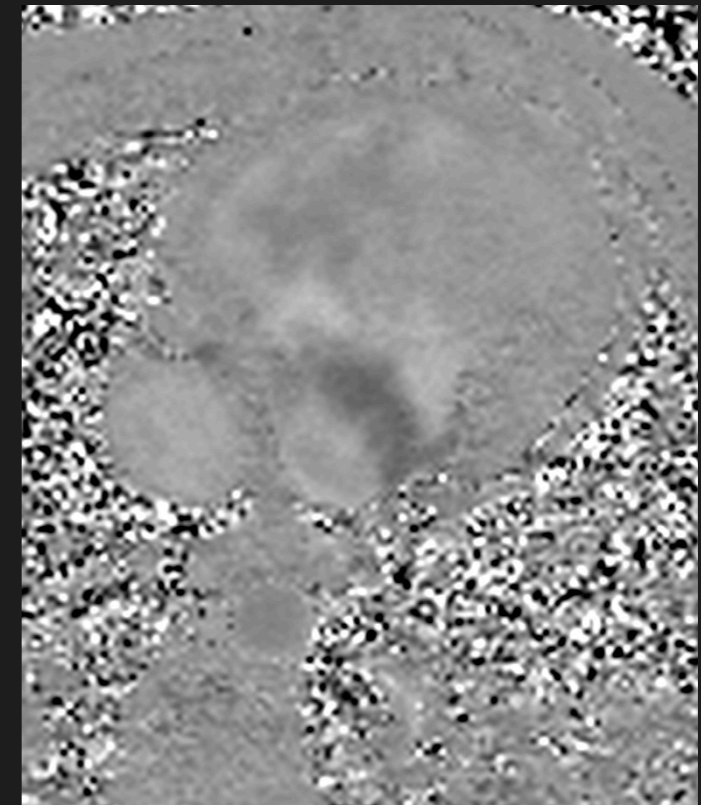

IVC/DAo

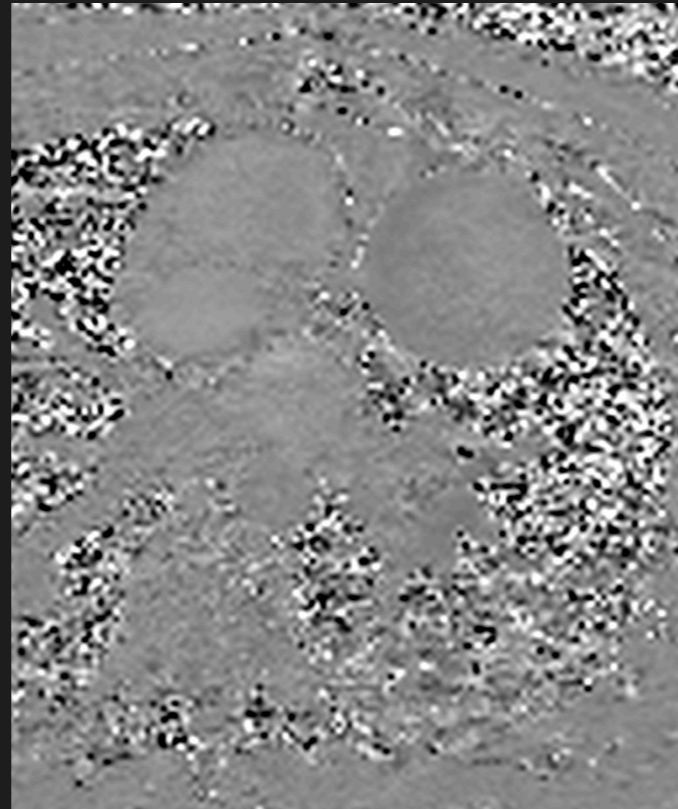
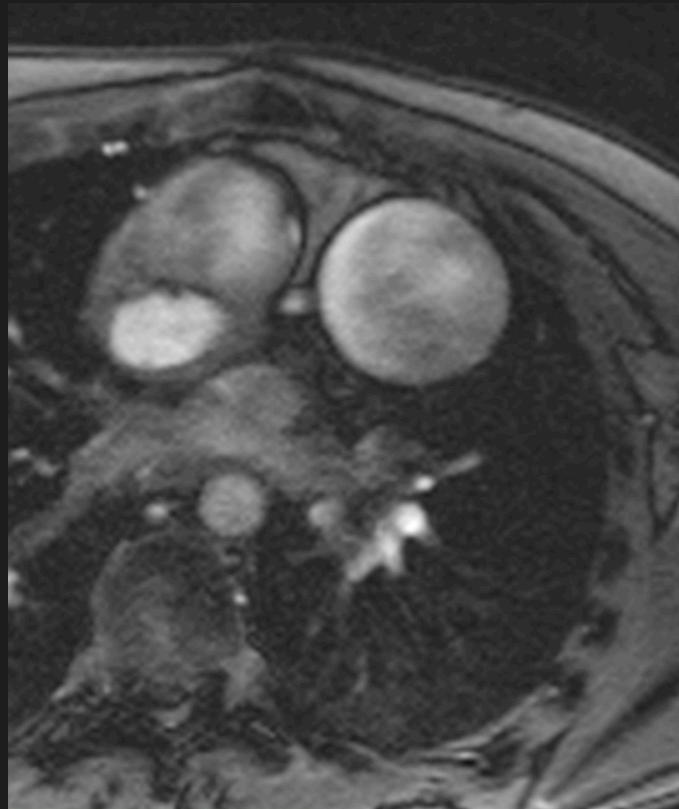

Large vessels

Swirling flow

Inaccurate Q estimation

Be creative!

Different ways to calculate QS

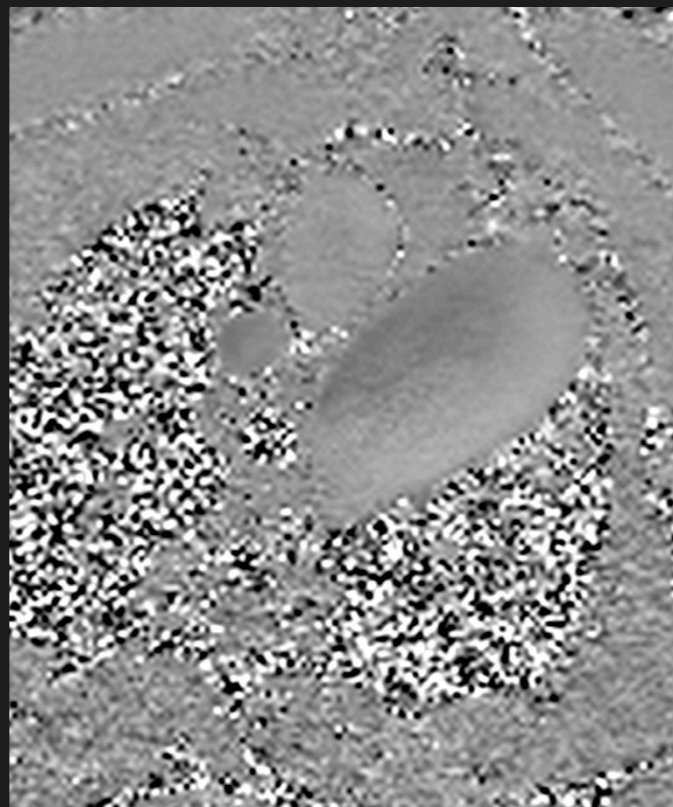

SVC

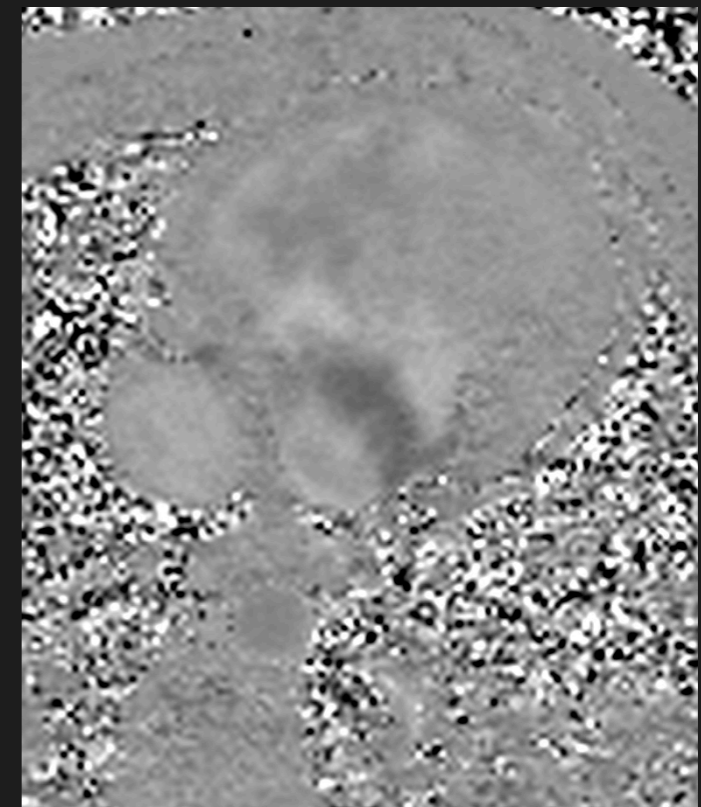

IVC/DAo

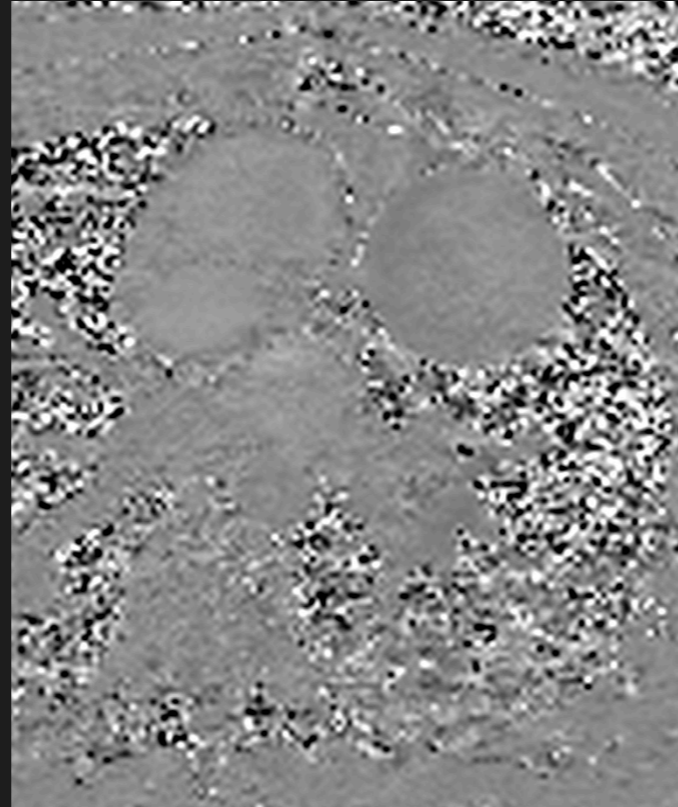
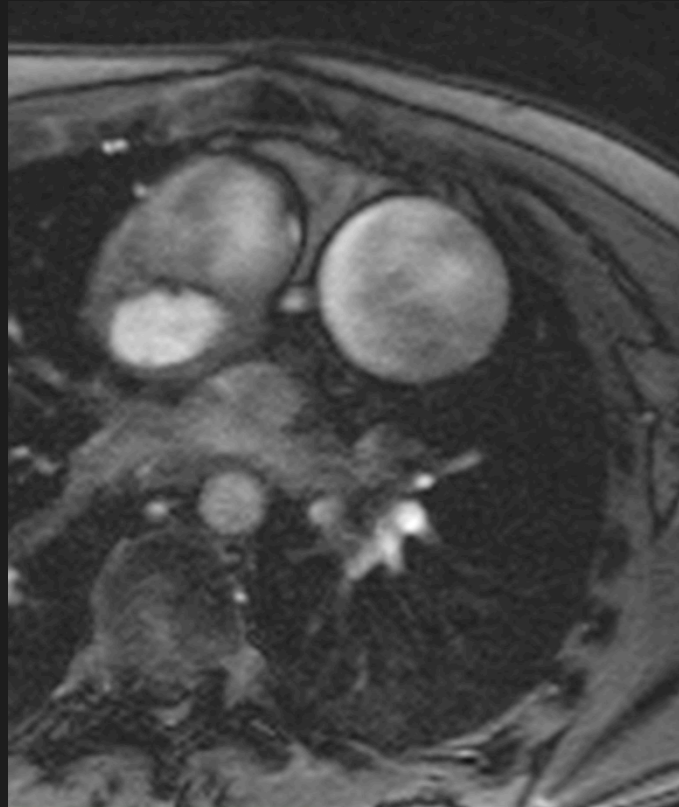

Large vessels

Swirling flow

Inaccurate Q estimation

Be creative!

Different ways to calculate QS

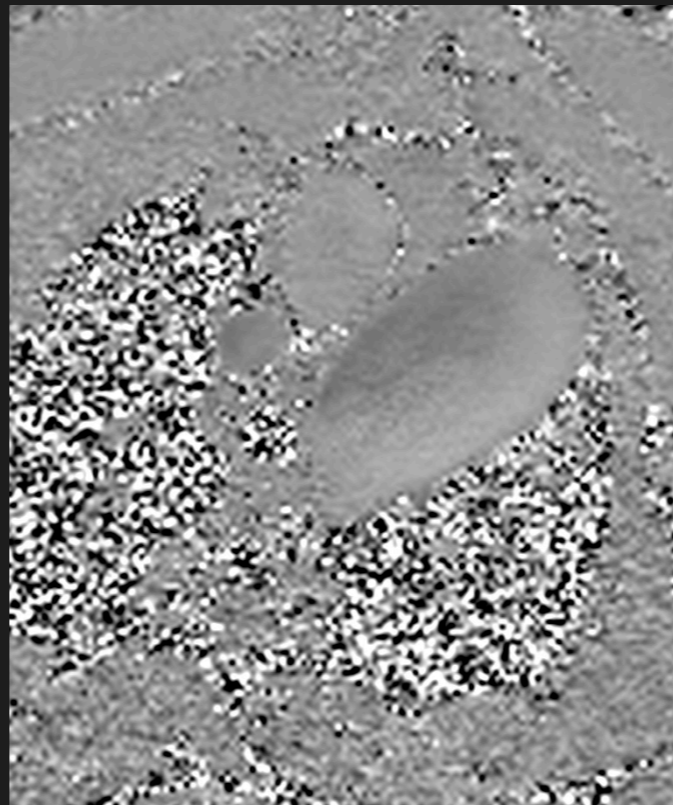

SVC

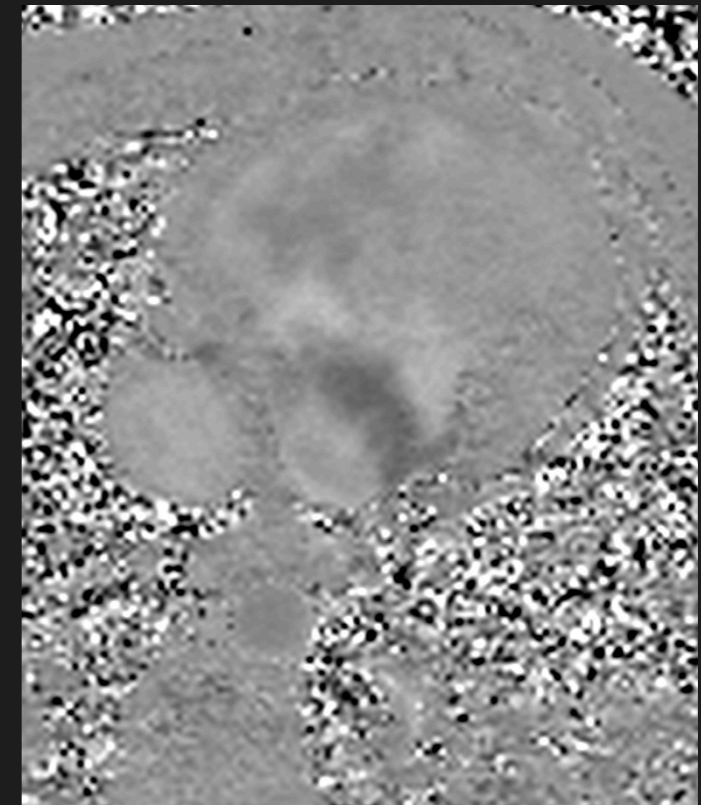

IVC/DAo

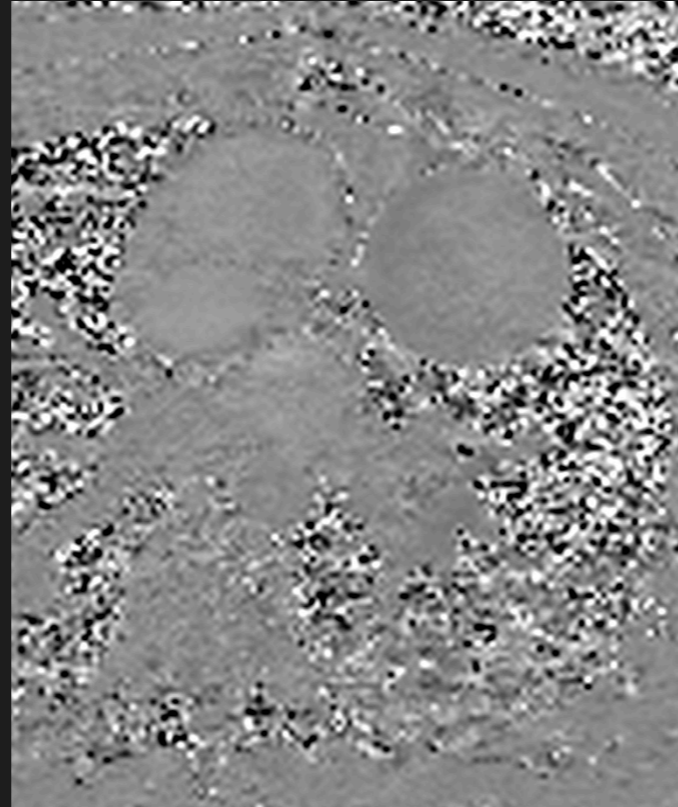
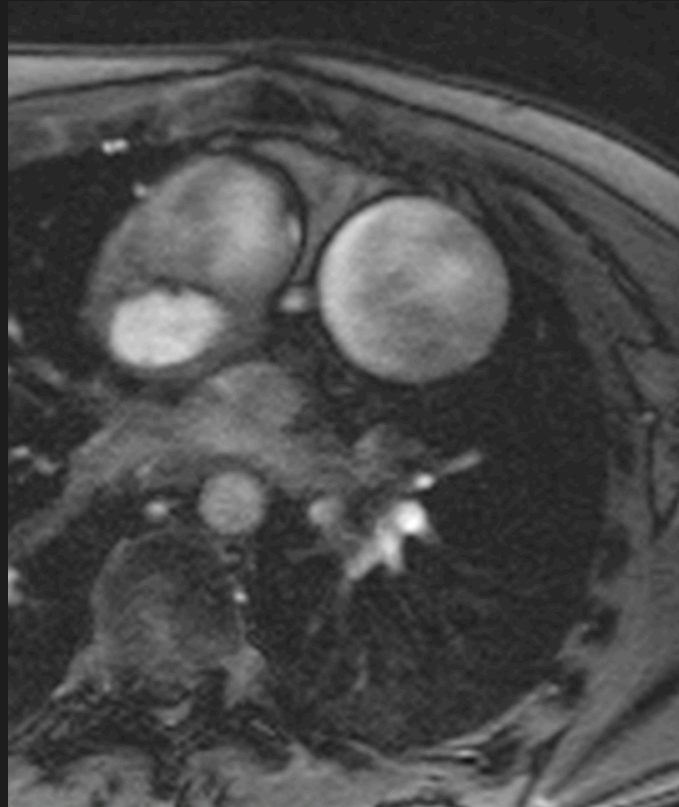

Large vessels

Swirling flow

Inaccurate Q estimation

Be creative!

Different ways to calculate QS

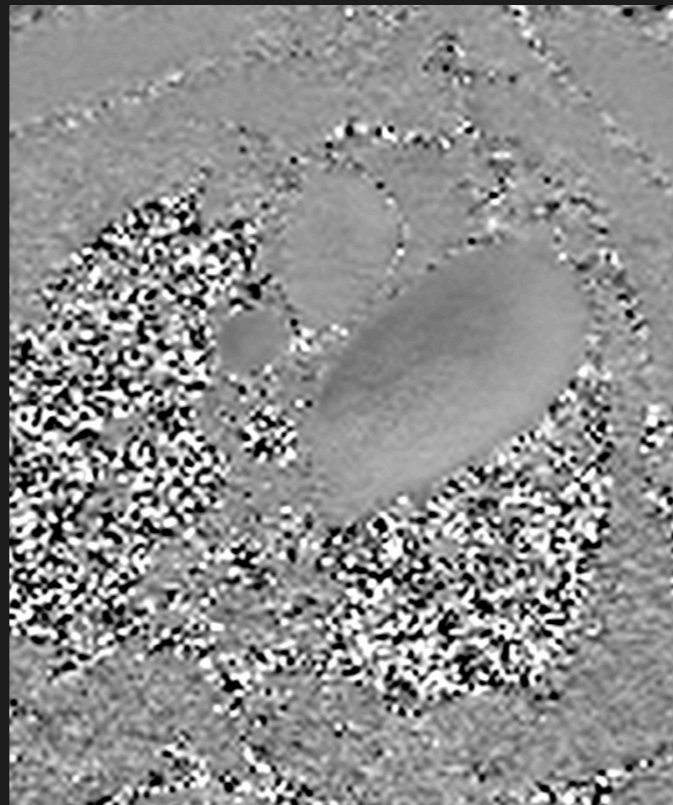

SVC

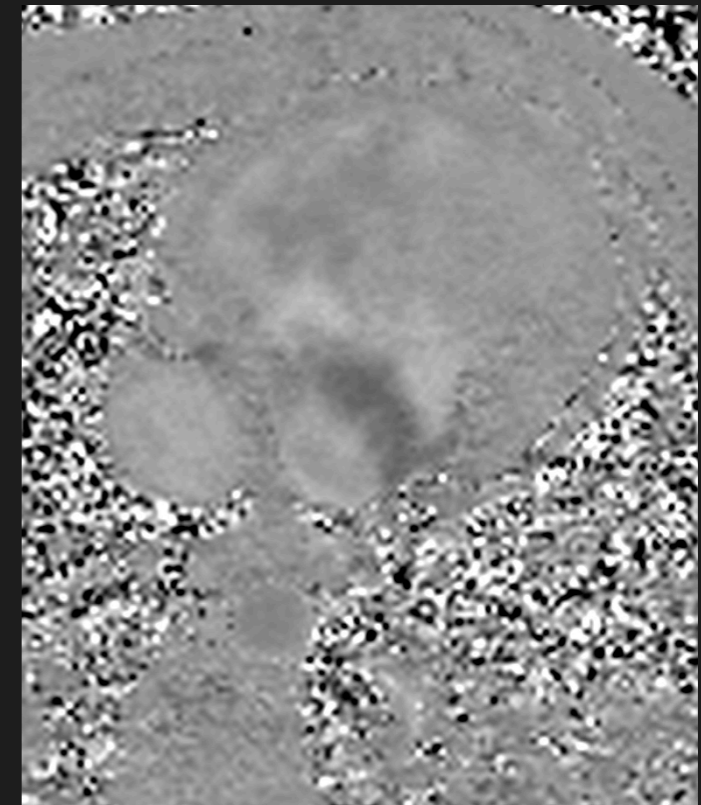

IVC/DAo

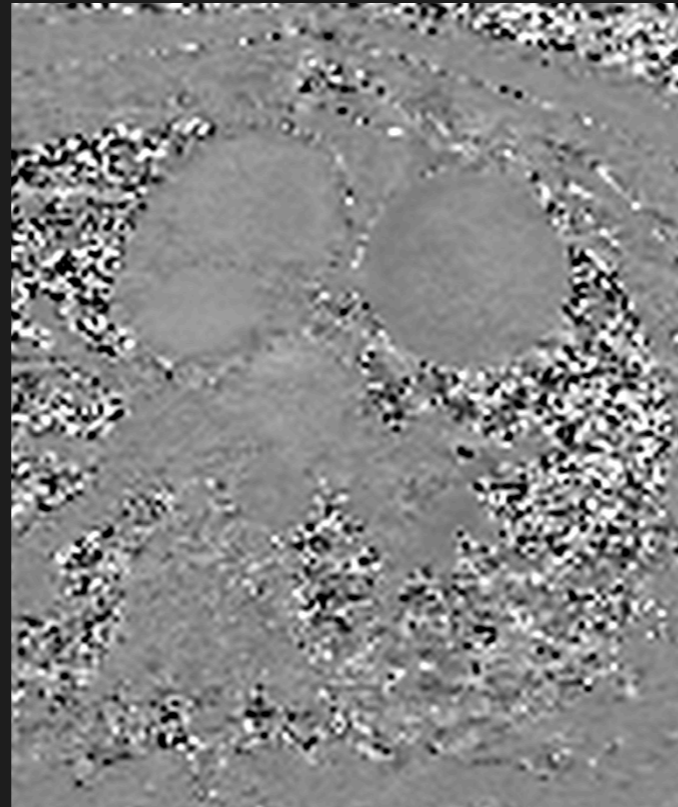
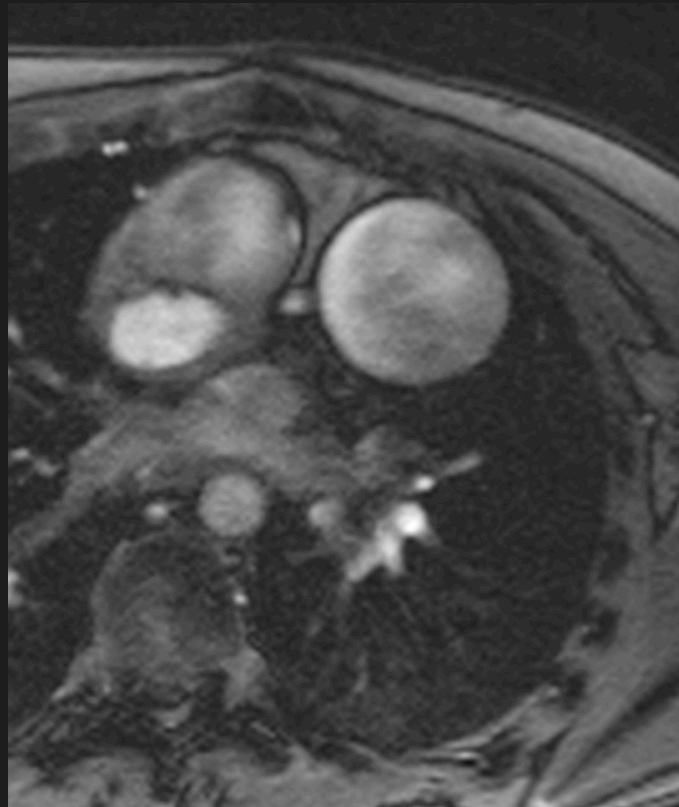

Large vessels

Swirling flow

Inaccurate Q estimation

Be creative!

Different ways to calculate QS

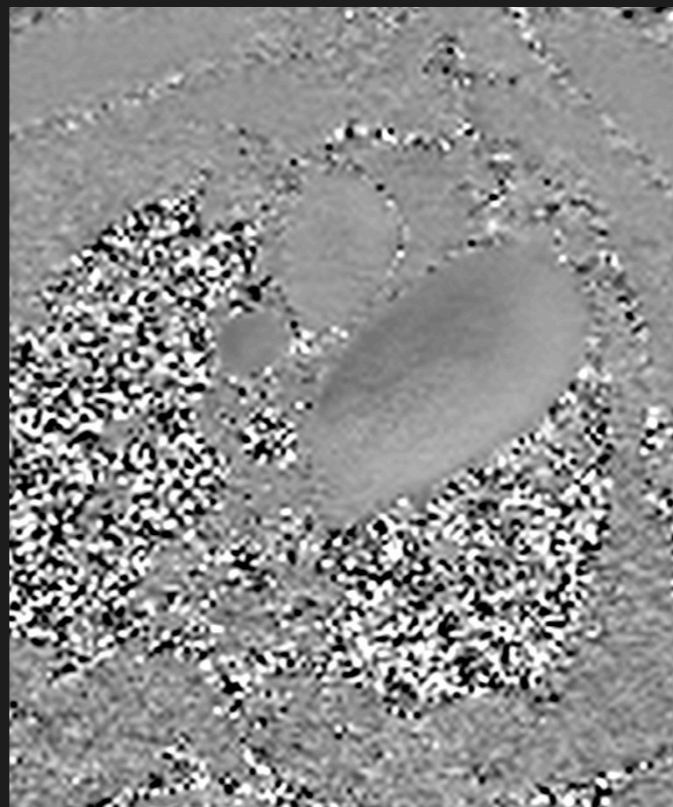

SVC

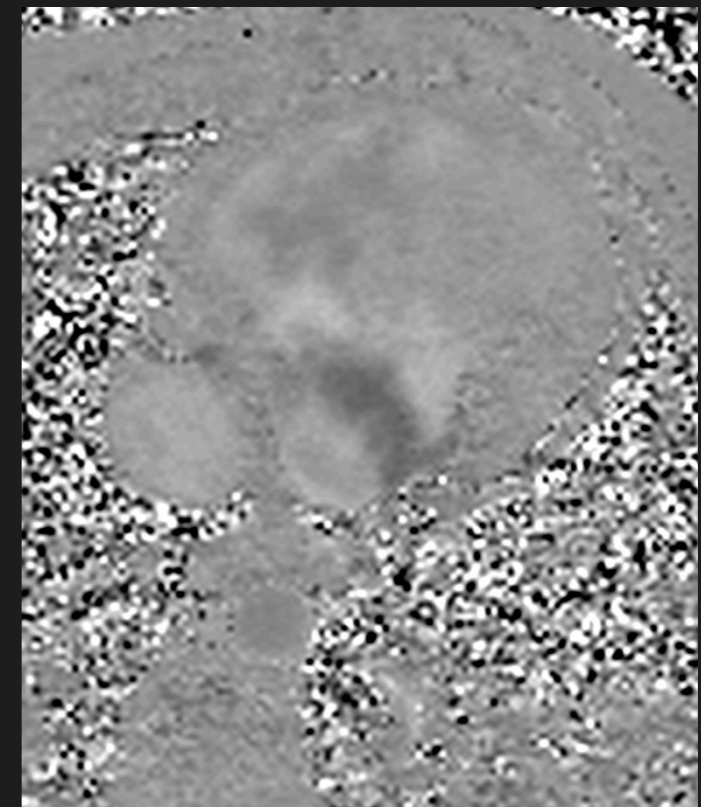

IVC/DAo







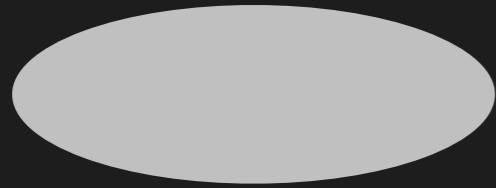

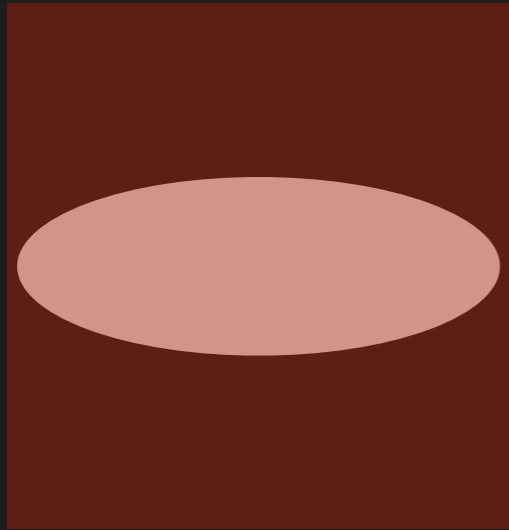

Square FOV

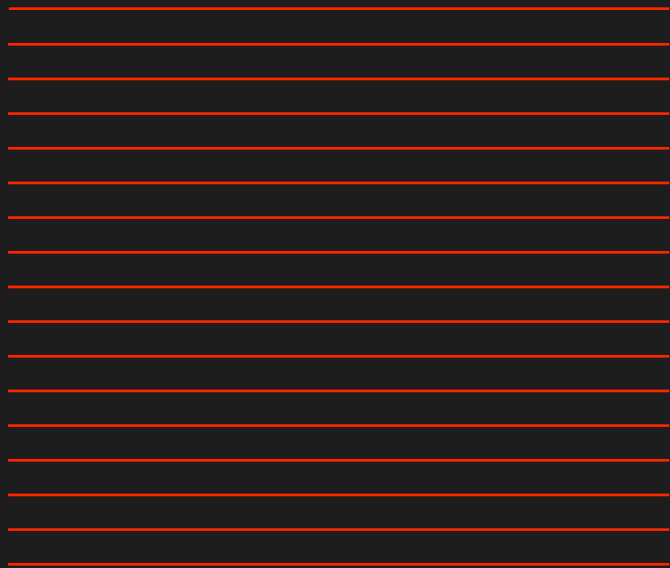

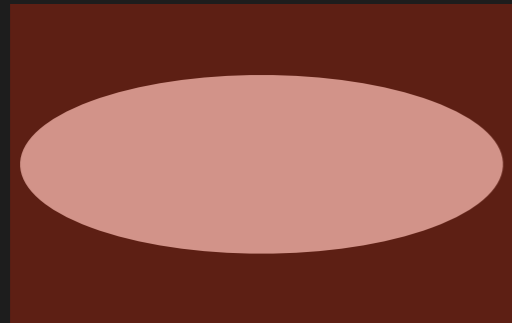

Square FOV

Smaller FOV - PE direction



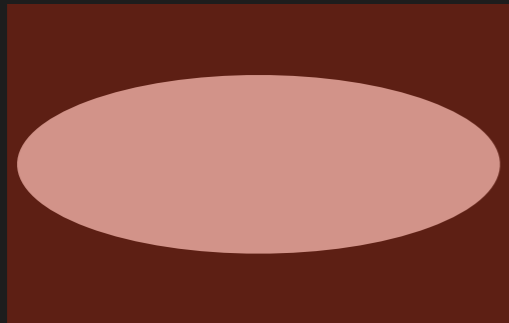

**Square FOV**

**Smaller FOV - PE direction**

**Increase resolution**



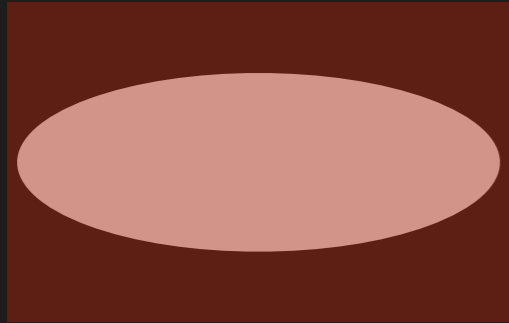

**Square FOV**

**Smaller FOV - PE direction**

**Increase resolution**

**Lose lines**

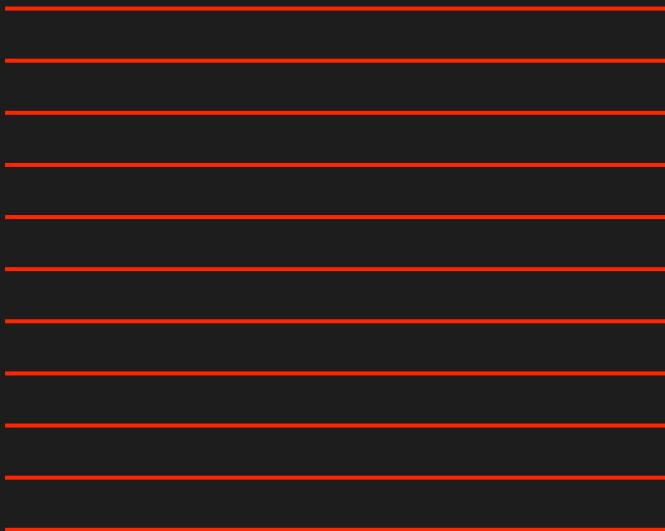

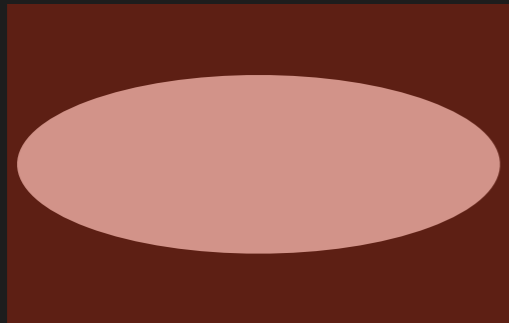

**Square FOV**

**Smaller FOV - PE direction**

**Increase resolution**

**Lose lines**

**Same resolution**

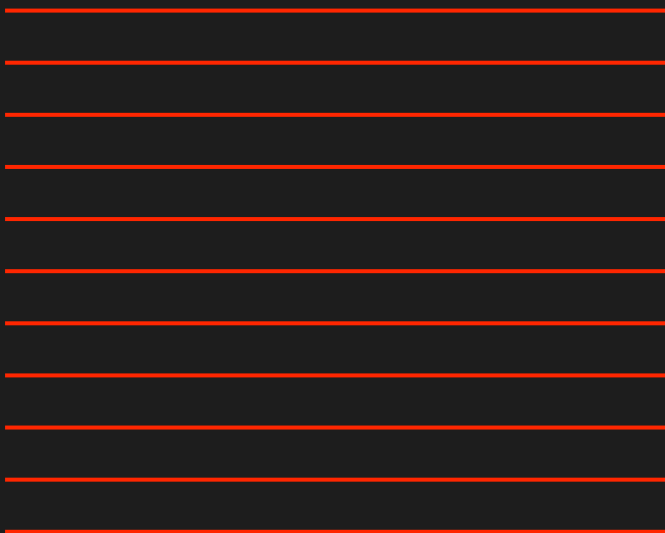

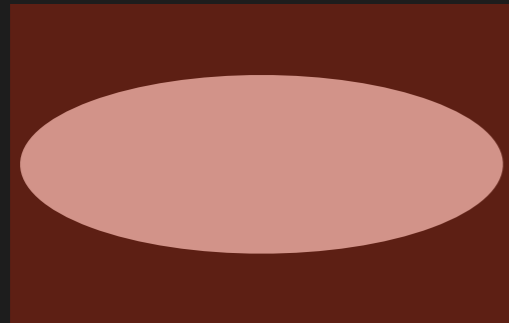

**Square FOV**

**Smaller FOV - PE direction**

**Increase resolution**

**Lose lines**

**Same resolution**

**Shorter time - loss of SNR**

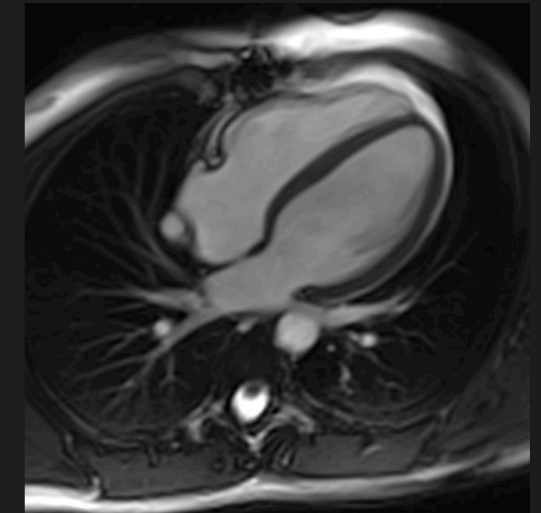

FOV = 350mm

Matrix = 192\*192

Scan time = 16s

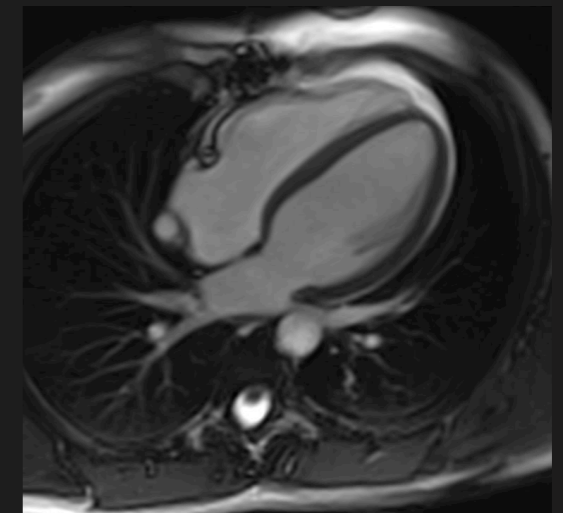

FOV = 350mm

Matrix = 144\*192

Scan time = 12s

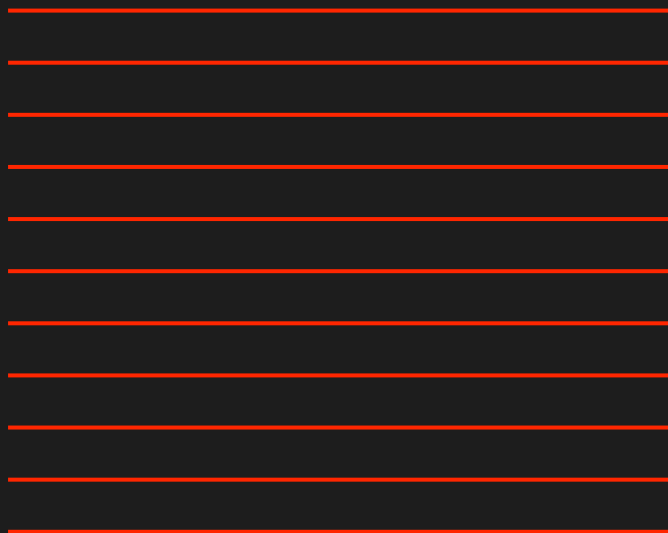





# MRI physics

Takes time



MRI physics

Ask someone

Takes time

MRI physics

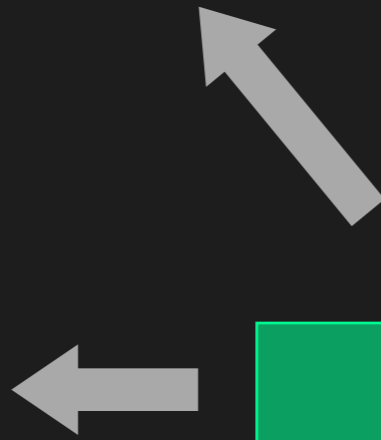

Ask someone

Create a model

Takes time

MRI physics



